

# NDX-06BTMOU-A0600F



## DLX® Fiber Indexing Terminal, 1x4 Splitter, 4 Forward Ports, 1 Reverse Port, Dielectric Flat Loose Tube Cable, 600 Feet

- Fiber Indexing terminals are access terminals using hardened connectivity technology that withstand the rugged outside plant environment
- Fiber Indexing terminals eliminate splicing and use 12-strand fiber cable in a daisy-chain topology, reducing the total required cable length by up to 70%
- Hardened adapters are factory-terminated and environmentally sealed to ensure rapid plug-and-play drop cable installations

## Product Classification

<b>Regional Availability</b>	North America
<b>Product Type</b>	Access terminal, indexed with splitter
<b>Product Brand</b>	DLX®
<b>Product Series</b>	NDX

## General Specifications

<b>Cable Type</b>	Dielectric - Flat - Loose Tube
<b>Cable, quantity</b>	1
<b>Distribution Type</b>	1 x 4 splitter
<b>Enclosure Color</b>	Black
<b>Forward Port Type</b>	Hardened mini-size (DLX) adapter
<b>Forward Port, quantity</b>	4
<b>Mounting</b>	Handhole   Pedestal   Pole
<b>Port Type</b>	Hardened multi-fiber (HMFOC) jack, male/pinned
<b>Port, quantity</b>	4
<b>Reverse Port Type</b>	Hardened mini-size DLX
<b>Reverse Port, quantity</b>	1
<b>Splitter, quantity</b>	1
<b>Stub Type</b>	Hardened multi-fiber (HMFOC) plug

## Dimensions

<b>Height</b>	297.8 mm   11.724 in
<b>Width</b>	130.3 mm   5.13 in

# NDX-06BTMOU-A0600F

<b>Depth</b>	90.4 mm   3.559 in
<b>Cable Length, stub</b>	600 ft (182 m)
<b>Cable Outer Diameter</b>	4.5 x 8.1 mm (0.18 x 0.32 in)

## Dimension Drawing

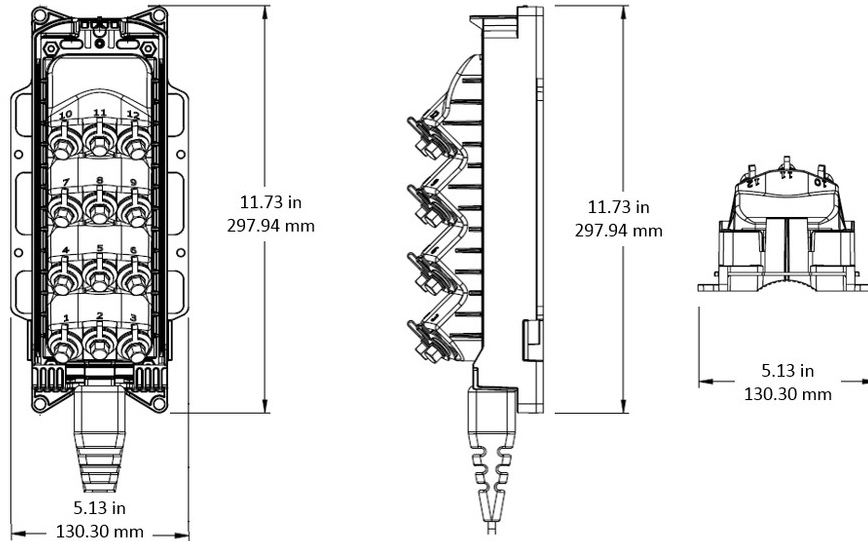

## Ordering Tree

# NDX-06BTMOU-A0600F



## Material Specifications

### Enclosure Material Type

Gasketed hardened plastic

## Optical Specifications

### Fiber Type

G.652.D

### Operating Wavelength Range

1260 – 1635 nm

### Attenuation Cable Coefficient, maximum

0.30 dB/km @ 1550 nm | 0.40 dB/km @ 1310 nm

### Attenuation Splitter, maximum

7.1 dB

### Attenuation Terminal Connectors, maximum

0.45 dB

### Directivity, minimum

60 dB

### Uniformity, maximum

0.8 dB

### Insertion Loss, Splitter, typical

6.7 dB

### Insertion Loss, Stub Connector, maximum

0.45 dB

### Insertion Loss, Stub Connector, typical

0.16 dB

### Insertion Loss, Terminal Connector, typical

0.16 dB

### Return Loss, Connector, minimum

65 dB

# NDX-06BTMOU-A0600F

**Return Loss, Single Ports, minimum** 55 dB

## Environmental Specifications

**Operating Temperature** -40 °C to +70 °C (-40 °F to +158 °F)  
**Relative Humidity** 5%–100%, condensing  
**Environmental Space** Above ground | Below ground | Buried  
**Flammability Rating** UL 94 V-0  
**Qualification Standards** IEC 60529, IP68 + 2 m waterhead | NEMA, Type 6 + 10 ft waterhead | Telcordia GR-3120-CORE | Telcordia GR-326-CORE | Telcordia GR-771-CORE  
**UV Resistance** UV stabilized

## Packaging and Weights

**Included** Enclosure (1) | Optical splitter (1) | Universal mounting bracket (1)  
**Packaging quantity** 1  
**Packaging Type** Box | Carton  
**Weight, without cable** 1 kg | 2.205 lb

## Regulatory Compliance/Certifications

Agency	Classification
CHINA-ROHS	Below maximum concentration value
ISO 9001:2015	Designed, manufactured and/or distributed under this quality management system
REACH-SVHC	Compliant as per SVHC revision on <a href="http://www.commscope.com/ProductCompliance">www.commscope.com/ProductCompliance</a>
ROHS	Compliant
UK-ROHS	Compliant



## Included Products

MST-UMB-MINI – DLX® Mini-MST, Fiber Optic Universal Mounting Bracket