

Round Splice Tray

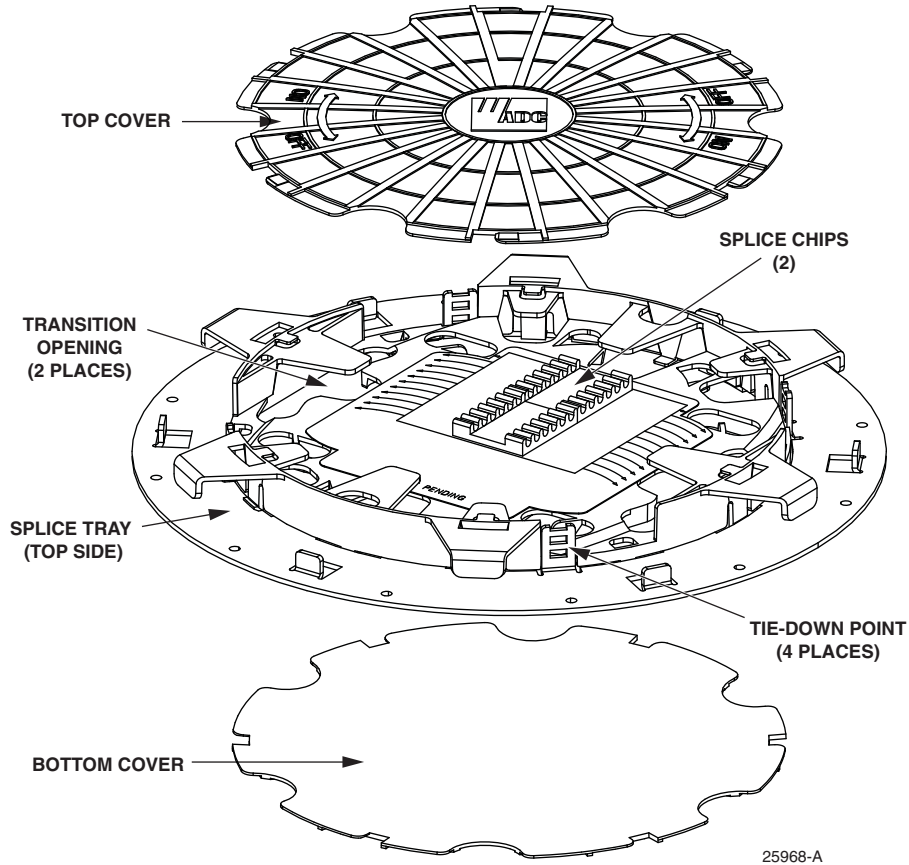

Content	Page
INTRODUCTION	2
1 DESCRIPTION	2
1.1 Roll-Up Direction	2
2 OVERVIEW OF PROCEDURES	3
3 CABLE PREPARATION	4
4 CABLE ROUTING (STANDARD SPLICE CONFIGURATION)	4
4.1 Clockwise Roll-Up Procedure	6
4.1.1 Cable(s) "A" (Typically IFC Cable).....	6
4.1.2 Cable(s) "B" (Typically OSP Cable)	9
4.2 Counter-Clockwise Roll-Up Procedure	10
4.2.1 Cable(s) "A" (Typically IFC Cable).....	10
4.2.2 Cable(s) "B" (Typically OSP Cable)	13
5 CABLE ROUTING (24-FIBER, HEAT SHRINK SPLICE CONFIGURATION)	14

(CONTINUED)

Content	Page
5.1 Clockwise Roll-Up Procedure (24-Fiber, Heat Shrink Splice Configuration)	15
5.1.1 Cable(s) “1A” and “1B” (Typically IFC Cable)	15
5.1.2 Cable(s) “2A” and “2B” (Typically OSP Cable)	18
5.2 Counter-Clockwise Roll-Up Procedure (24-Fiber, Heat Shrink Splice Configuration)	19
5.2.1 Cable(s) “1A” and “1B” (Typically IFC Cable)	19
5.2.2 Cable(s) “2A” and “2B” (Typically OSP Cable)	22
6 CABLE ROUTING (4 STACKED RIBBONS USING OVAL-TUBING BREAKOUT KITS)	23
6.1 Clockwise Roll-up Procedure (4 Stacked Ribbons per Oval Tube)	25
6.2 Counter-Clockwise Roll-up Procedure (4 Stacked Ribbons per Oval Tube)	26
7 CABLE ROUTING (USING RIBBONS WITH MESH SLEEVE)	27
7.1 Standard Ribbon Application.	27
7.1.1 Clockwise Roll-up Procedure (Using Traditional Ribbons Matrix With Mesh Sleeve)	28
7.1.2 Counter-Clockwise Roll-up Procedure (sing Traditional Ribbons Matrix With Mesh Sleeve))	30
7.2 Procedure Used When OSP Cable is of Pliable Ribbon Construction	32
7.2.1 OSP Cable With Pliable Ribbon.	34
7.2.2 IFC Cable With Standard Ribbon	36
7.2.3 Completing the Splice Tray	36
8 CUSTOMER INFORMATION AND ASSISTANCE	36

INTRODUCTION

This manual provides instructions for routing fiber optic cables in a round splice tray. The round splice tray with the top and bottom covers removed is shown in the cover illustration.

Trademark Information

CommScope and CommScope (logo) are trademarks.

1 DESCRIPTION

The round splice tray provides cable management, storage, and splicing for multiple fiber optic cables. The tray can accommodate up to 24 stranded or up to 24 ribbon fibers. The tray consists of a top and bottom side for routing and storing fiber cables. The top side provides storage for splice protectors and excess fiber, bottom side is used to reverse the direction of half the fibers.

1.1 Roll-Up Direction

Cables can be rolled up in either a counter-clockwise direction or a clockwise direction, depending on which side of the panel (or frame) the cables originate. See [Figure 1](#). When tying the cable down on the left side of the panel or frame (as viewed from the front), use a counter-clockwise roll-up direction. When tying the cable down on the right side of the panel or frame (as viewed from the front), use a clockwise roll-up direction.

2 OVERVIEW OF PROCEDURES

Prepare the cable following [Section 3, Cable Preparation, on Page 4](#). Select the appropriate section for cable routing depending on whether this will be a standard splice configuration or a 24-fiber, heat shrink splice configuration.

- **Standard Splice Configuration**—For clockwise roll-up procedure, see [Section 4.1 on Page 6](#). For counter-clockwise roll-up procedure, see [Section 4.2 on Page 10](#).
- **24-Fiber, Heat Shrink Splice Configuration**—For clockwise roll-up procedure, see [Section 5.1 on Page 15](#). For counter-clockwise procedure, see [Section 5.2 on Page 19](#).
- **Standard Ribbon Cable Splice Configuration**—For clockwise roll-up procedure, see [Section 6.1 on Page 25](#). For counter-clockwise procedure, see [Section 6.2 on Page 26](#).
- **Ribbon Cable Using Mesh Sleeve**—For standard ribbon cables, see [Section 7.1 on Page 27](#). For standard and pliable ribbon configuration, see [Section 7.2 on Page 32](#).

► **Note:** If using multiple cables, identify cables by grouping fibers together with tape.

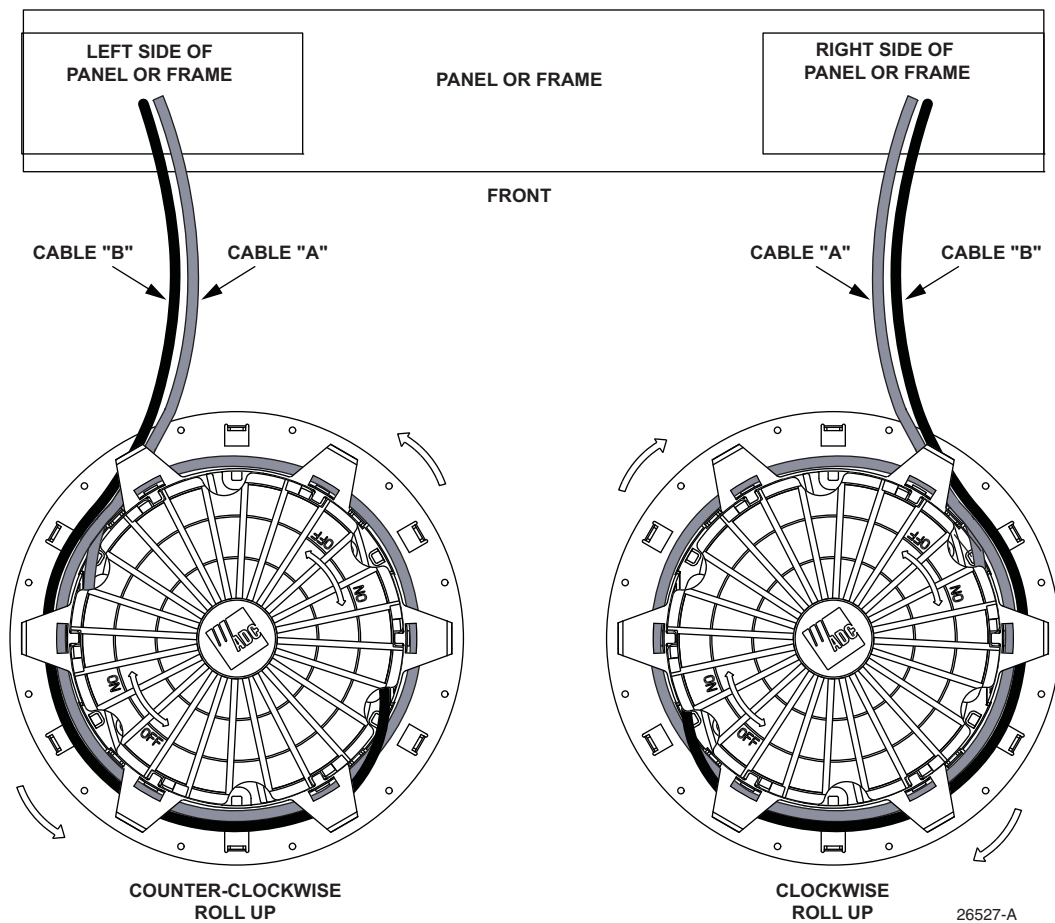

Figure 1. Counter-Clockwise and Clockwise Roll-Up Directions

3 CABLE PREPARATION

There are two lengths to determine when preparing the cable(s) routed to the round splice tray: the overall length (which will be referred to as the cut length) and the breakout length. See [Figure 2](#).

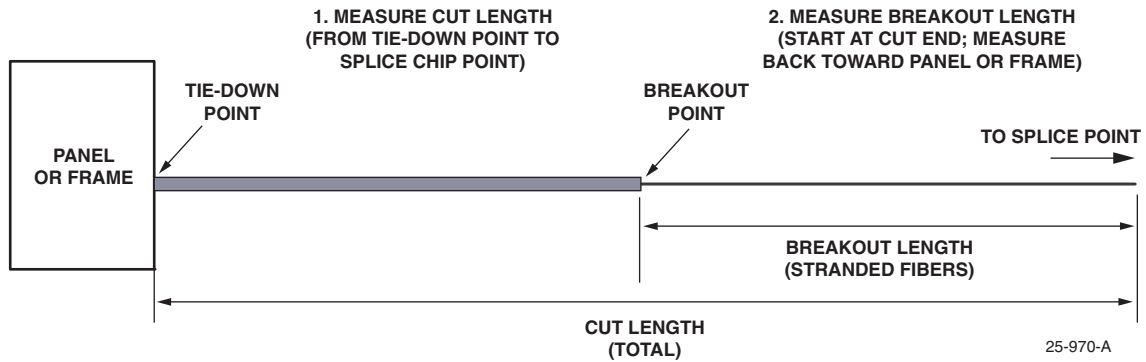

Figure 2. Fiber Lengths

The cut length is the overall length from the tie down point on the associated panel or frame to the splice chip point on the round splice tray. The breakout length is the length of stranded/ribbon fiber routed on the inside of the round splice tray from the breakout point to the splice chip point.

4 CABLE ROUTING (STANDARD SPLICE CONFIGURATION)

Route cable(s) “A” and cable(s) “B” to their designated panel and secure them to the panel or frame (tie down point) according to local practice. After securing the cable, proceed as follows:

1. Starting at the tie down location on the panel or frame, measure and mark the cut length. See [Figure 1](#). (Make sure cable(s) “A” and cable(s) “B” cut lengths are identical.)
2. Cut the cable at the cut length mark.

3. Starting at the cut end of the cable measure backwards (right-to-left, see Figure 2) and mark the breakout length (refer to Figure 1). Remove outer jacket to expose stranded/ribbon fibers. (Remove any moisture blocking compound from OSP fibers.)

Table 1. Fiber Lengths

CABLE	CUT LENGTH	BREAKOUT LENGTH	TOLERANCE
Cable(s) "A"	68 in. (minimum) to 146 in. (maximum)	48 in.	+1.0 in/ -0.0 in.
(Typically IFC cable)	172.7 cm (minimum) to 370.8 cm (maximum)	122 cm	+2.5 cm/-0.0 cm
Cable(s) "B"	Same length as cable(s) "A"	37 in.	+1.0 in./-0.0 in.
(Typically OSP cable)		94 cm	+2.5 cm/-0.0 cm

- **Note:** It is recommended to use the maximum cut length of 146 in. (370.8 cm) for cable(s) "A" and "B". Shorter cut lengths may be necessary for larger cable count and larger cable diameters.

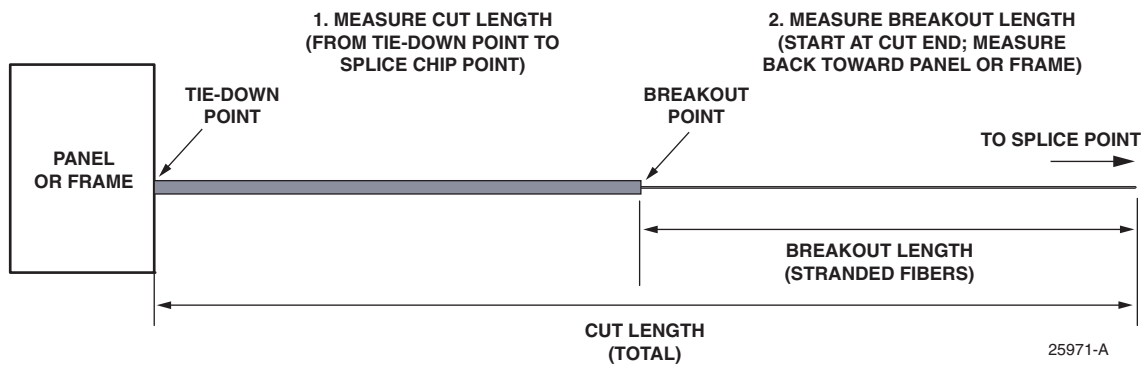

Figure 3. Fiber Lengths

4.1 Clockwise Roll-Up Procedure

4.1.1 Cable(s) "A" (Typically IFC Cable)

After removing the top and bottom covers, route cable(s) "A" as follows:

1. Route the cable so the fiber breakout is positioned at the transition point from top to bottom (refer to the "circled 1" in Figure 4). Then route and tie down cable(s) "A" as shown in Figure 4. (If multiple cables are used, route cables simultaneously.)

► **Note:** The circled numbers shown in Figure 4, Figure 5, and Figure 6 are provided as an orientation aid when flipping the cable tray over.

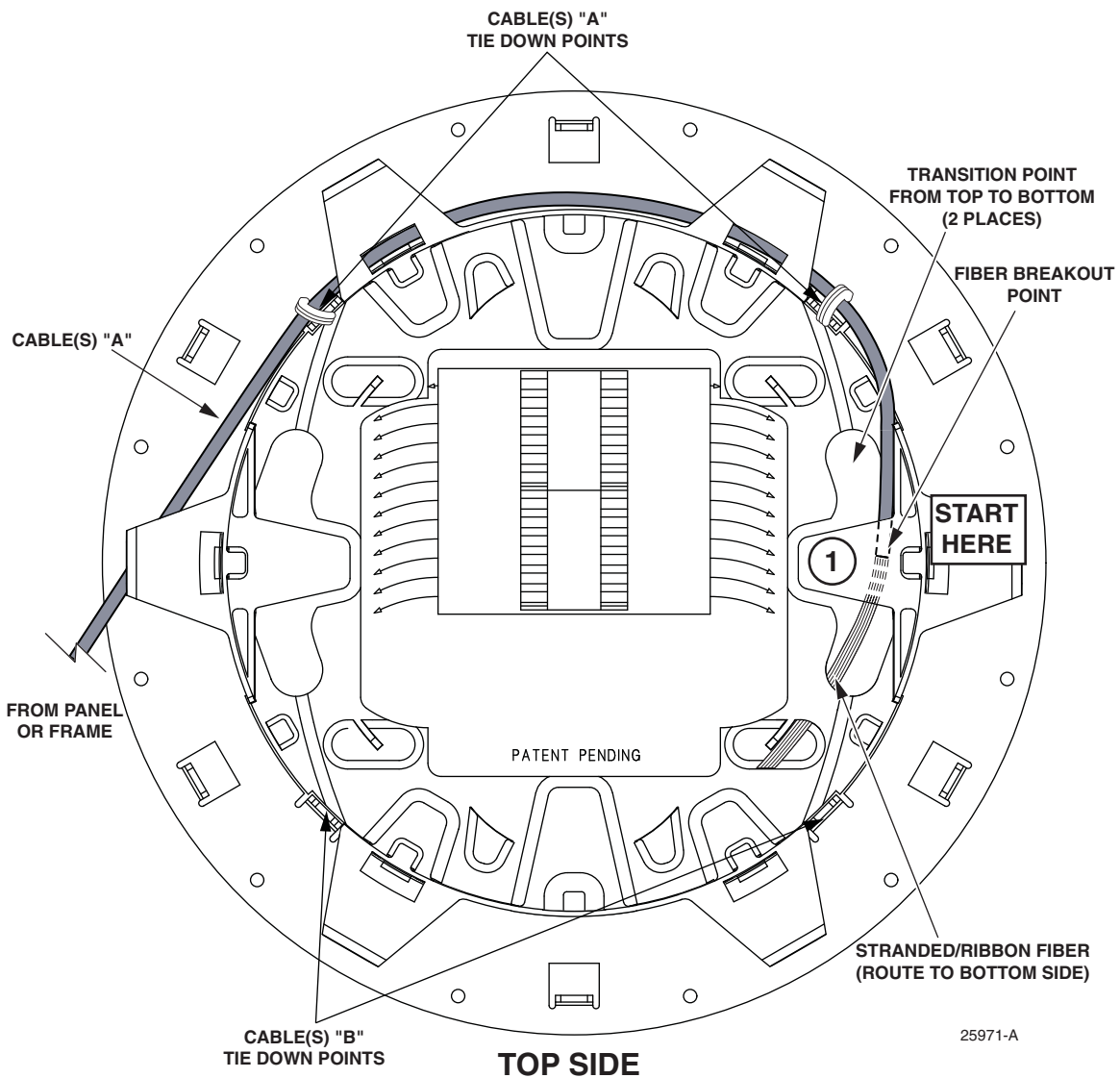

Figure 4. Cable(s) "A" Routing, Top Side (Clockwise Roll-Up Procedure)

2. Flip the tray over and continue routing cable(s) "A" around the spools and back to the top side, as shown in Figure 5. After routing cable(s) on bottom side, replace bottom cover.

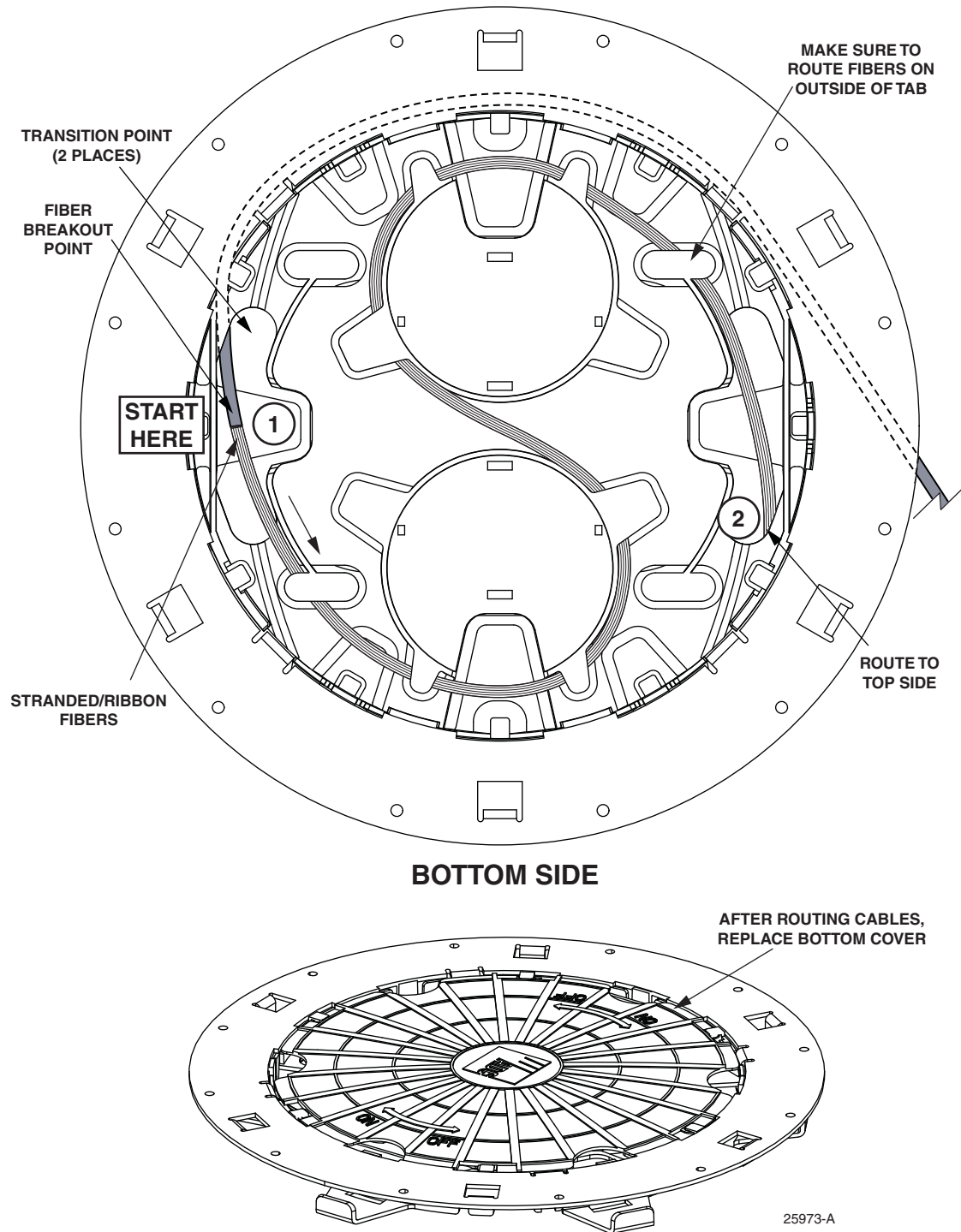

Figure 5. Cable(s) "A" Routing, Bottom Side (Clockwise Roll-Up Procedure), continued

3. Flip the tray over to the top side and route cable(s) "A" to the splice tray area as shown in Figure 6. Make sure to route the stranded/ribbon fibers 1.5 times around the inside of the tray making the loop as large as possible to ensure maximum fiber storage.

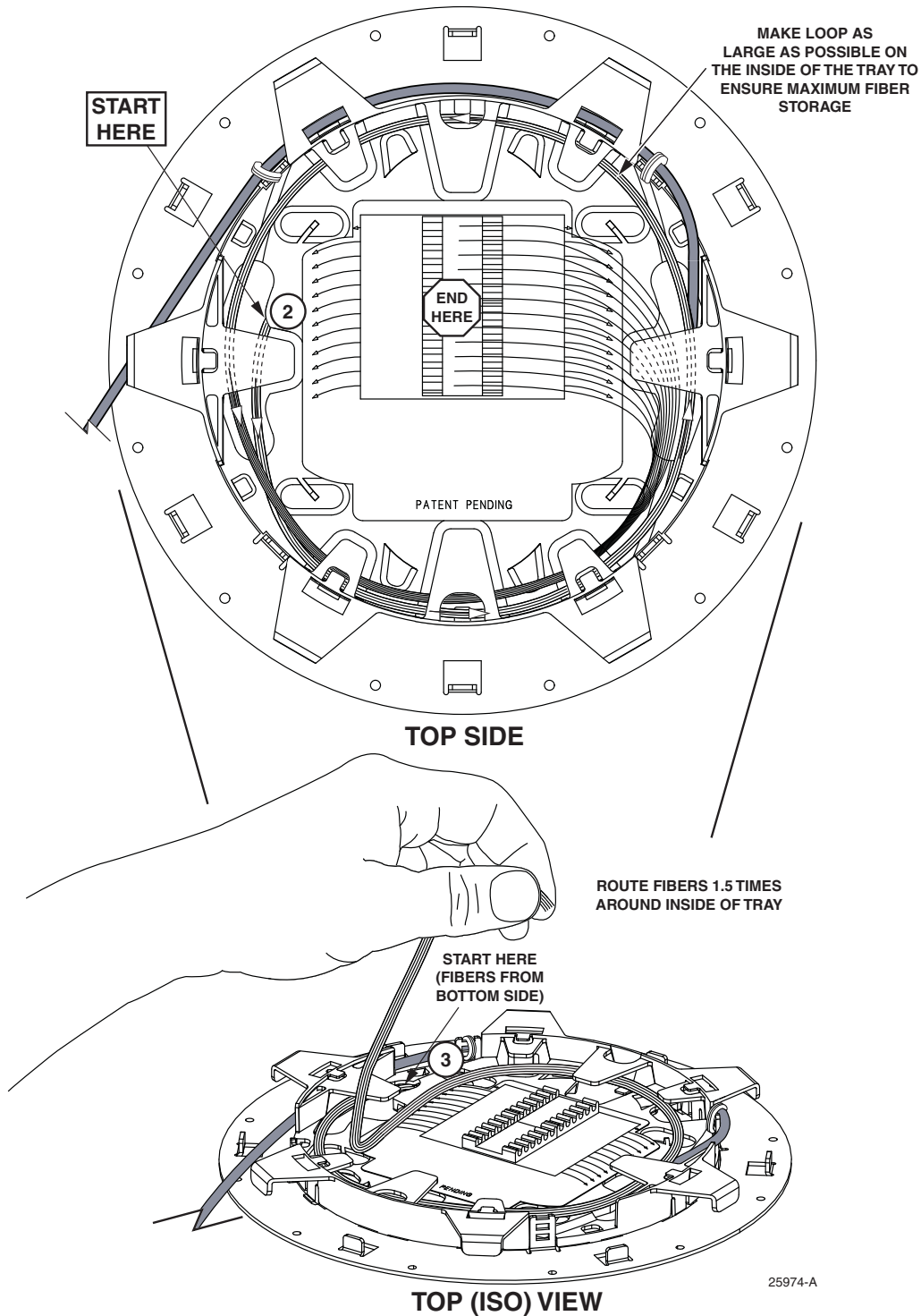

Figure 6. Cable(s) "A" Routing, Top Side (Clockwise Roll-Up Procedure), continued

4.1.2 Cable(s) "B" (Typically OSP Cable)

Route and tie down cable(s) "B" on the top side of the cable tray as shown in Figure 7. (If multiple cables are used, route cables simultaneously.) Make sure to route cable(s) "B" two times around the inside of the tray making the loop as large as possible to ensure maximum fiber storage.

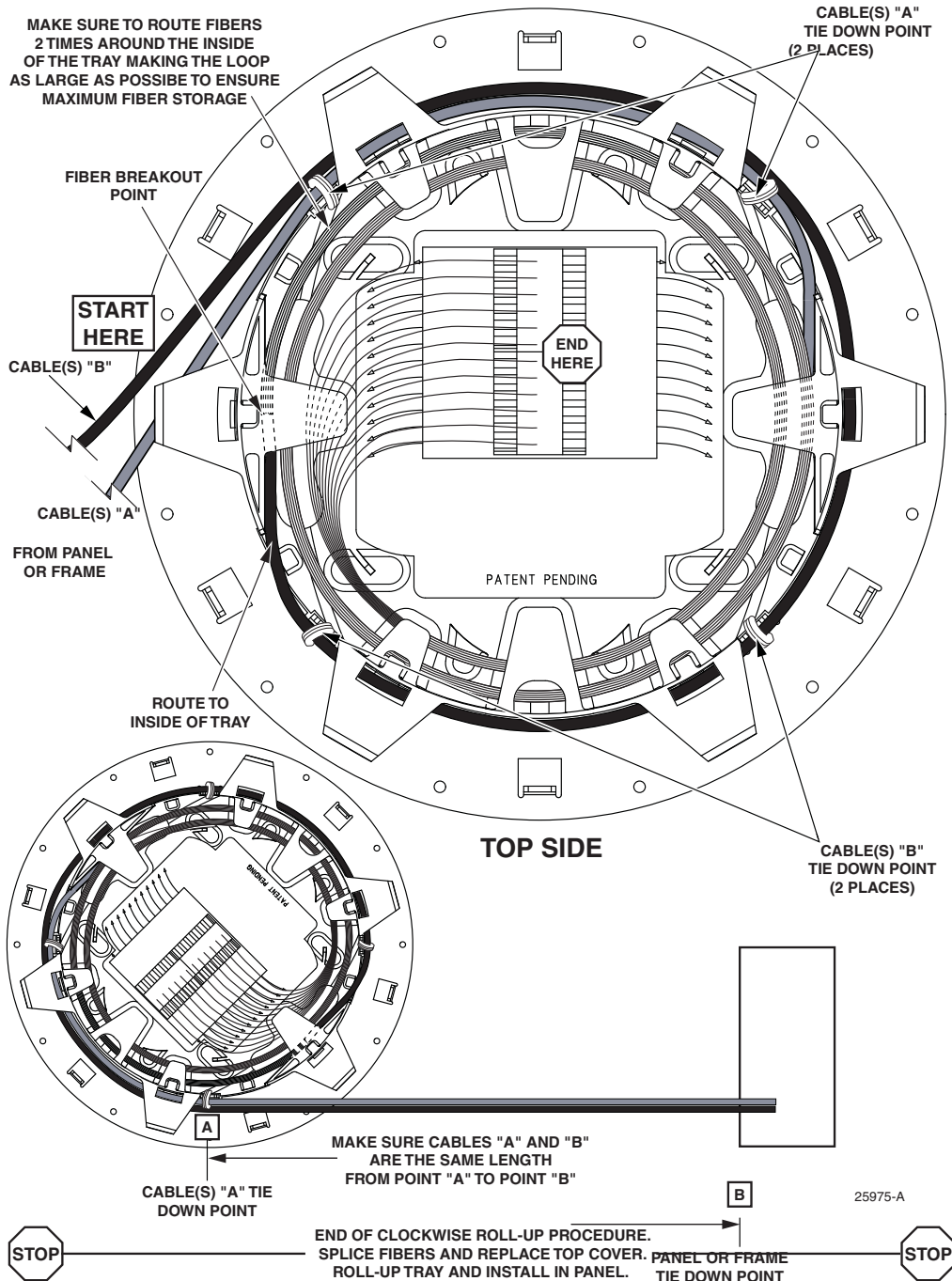

Figure 7. Cable(s) "B" Routing (Clockwise Roll-Up Procedure)

4.2 Counter-Clockwise Roll-Up Procedure

4.2.1 Cable(s) "A" (Typically IFC Cable)

After removing the top and bottom covers, route cable(s) "A" as follows:

1. Route the cable so the fiber breakout is positioned at the transition point from top to bottom (refer to the "circled 1" in Figure 8). Then route and tie down cable(s) "A" as shown in Figure 8 (If multiple cables are used, route cables simultaneously.)

► **Note:** The circled numbers shown in Figure 8, Figure 9, and Figure 10 are provided as an orientation aid when flipping the cable tray over.

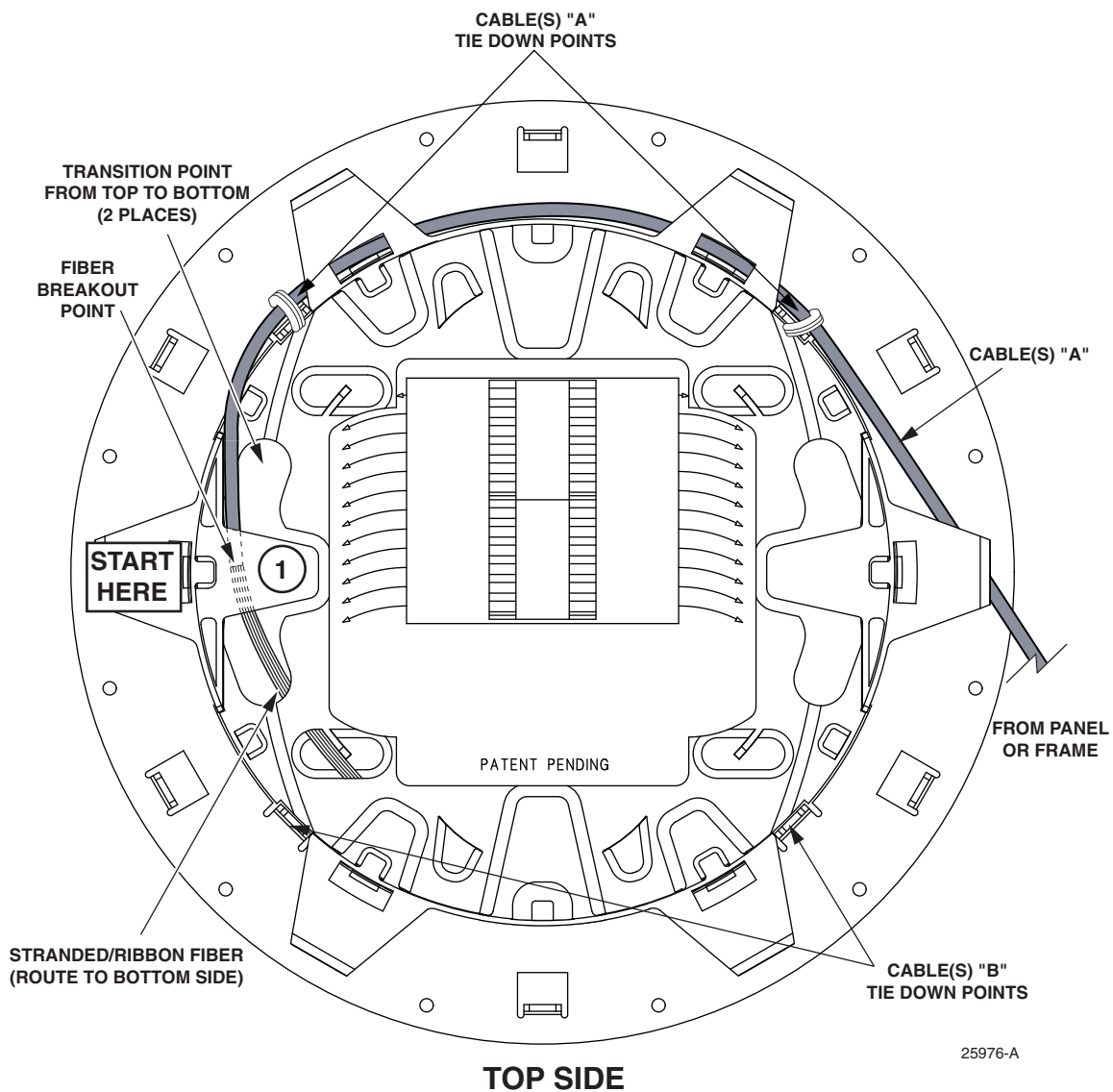

Figure 8. Cable(s) "A" Routing, Top Side (Counter-Clockwise Roll-Up Procedure)

- Flip the tray over and continue routing cable(s) “A” around the spools and back to the top side, as shown in Figure 9. After routing the cable(s) on the bottom side, replace the bottom cover.

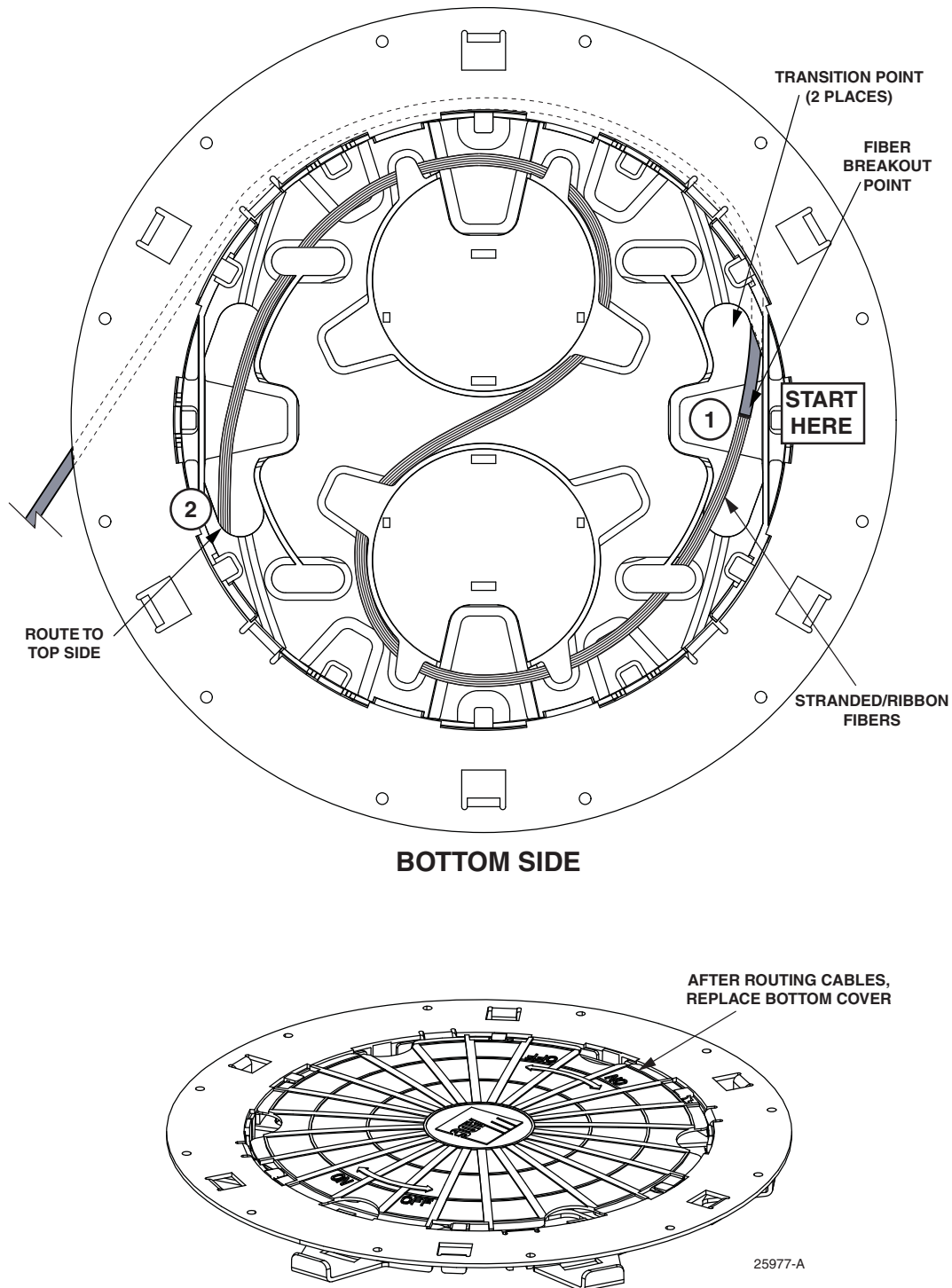

Figure 9. Cable(s) “A” Routing, Bottom Side (Counter-Clockwise Roll-Up Procedure), continued

3. Flip the tray over to the top side and route cable(s) "A" to the splice tray area as shown in Figure 10. Make sure to route the stranded/ribbon fibers 1.5 times around the inside of the tray making the loop as large as possible to ensure maximum fiber storage.

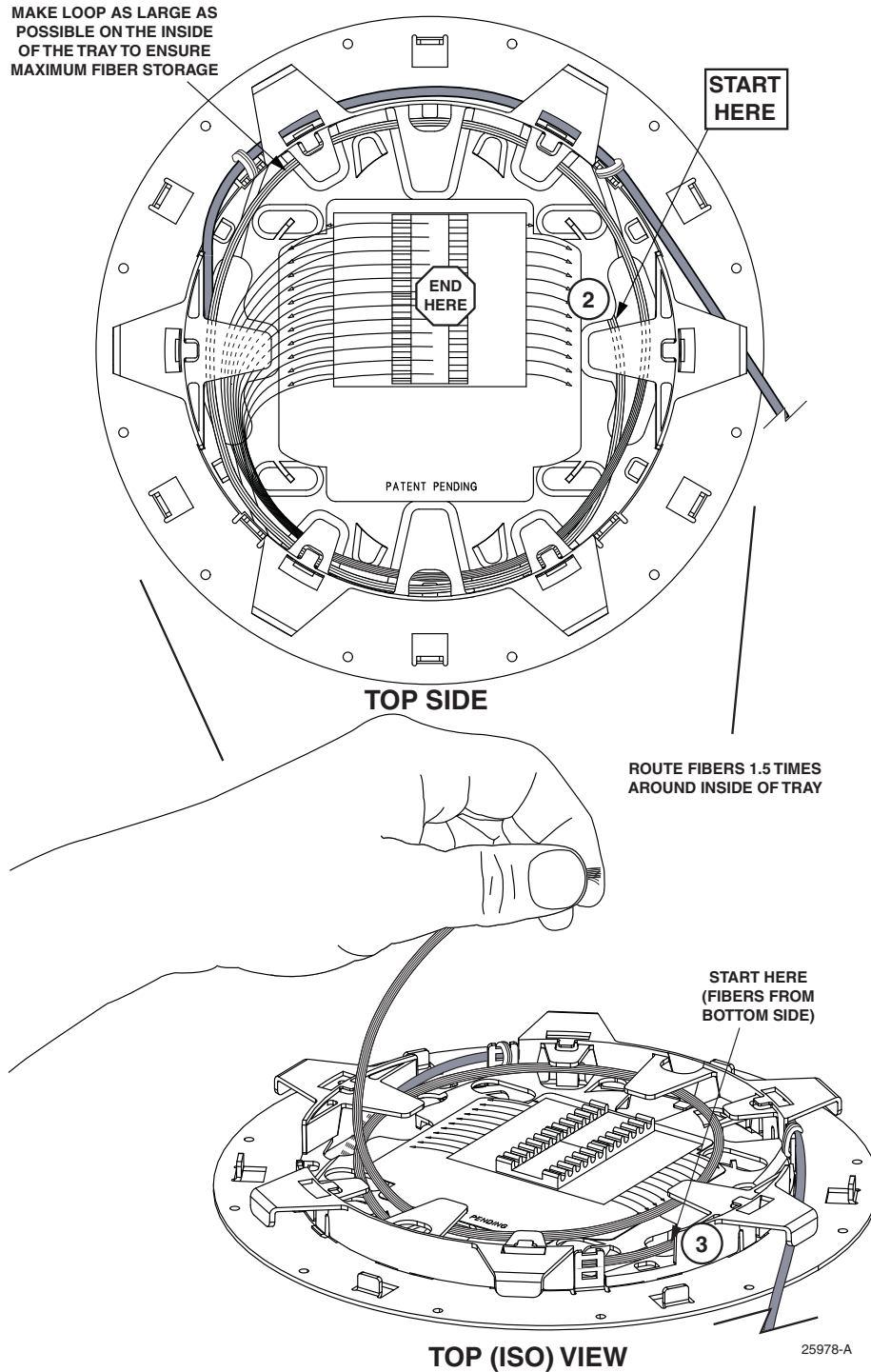

Figure 10. Cable(s) "A" Routing, Top Side (Counter-Clockwise Roll-Up Procedure), continued

4.2.2 Cable(s) "B" (Typically OSP Cable)

1. Route and tie down cable(s) "B" on the top side of the cable tray as shown in Figure 11. (If multiple cables are used, route cables simultaneously.) Make sure to route cable(s) "B" two times around the inside of the tray making the loop as large as possible to ensure maximum fiber storage.

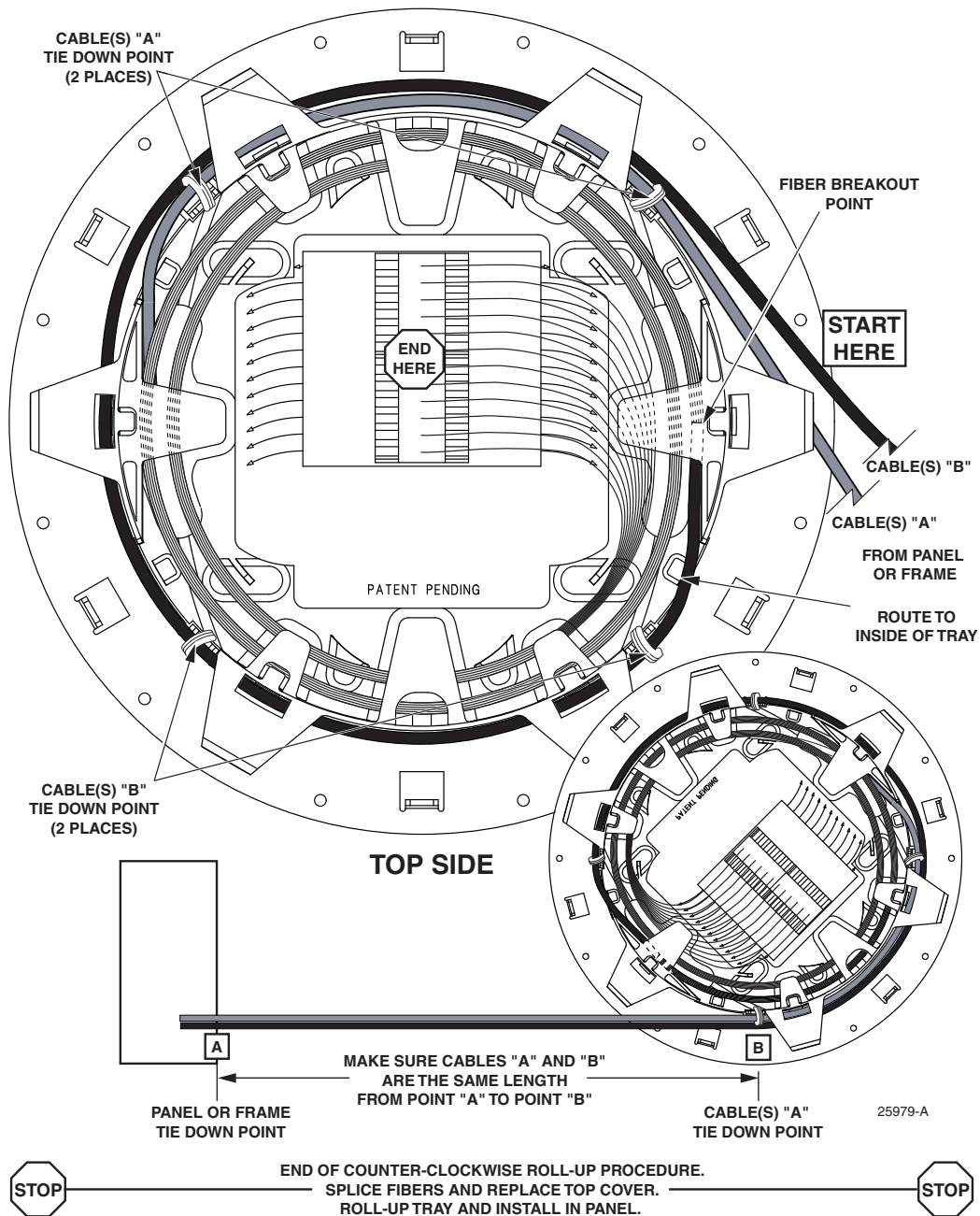

Figure 11. Cable(s) "B" Routing (Counter-Clockwise Roll-Up Procedure)

5 CABLE ROUTING (24-FIBER, HEAT SHRINK SPLICE CONFIGURATION)

Route cables “1A and 1B” and cables “2A and 2B” to their designated panel and secure them to the panel or frame (tie down point) according to local practice. After securing the cables, proceed as follows:

1. Starting at the tie down location on the panel or frame, measure and mark the cut length. See [Table 2](#).
2. Cut the cable at the cut length mark.
3. Starting at the cut end of the cable measure backwards (right-to-left, see [Figure 12](#)) and mark the breakout length (refer to [Table 2](#)). Remove outer jacket to expose stranded/ribbon fibers. (Remove any moisture blocking compound from OSP fibers.)

Table 2. Fiber Lengths

CABLE	CUT LENGTH	BREAKOUT LENGTH	TOLERANCE
Cable(s) “1A”	68 in. (minimum) to 96 in. (maximum)	48 in.	+1.0 in./-0.0 in.
(Typically IFC cable)	172.7 cm (minimum) to 243.8 cm (maximum)	122 cm	+2.5 cm/-0.0 cm
Cable(s) “1B”	Must be cut 8 in. (20.3 cm) shorter than cable(s) “1A”	40 in.	+1.0 in./-0.0 in.
(Typically IFC cable)		102 cm	+2.5 cm/-0.0 cm
Cable(s) “2A”	Same length as cable(s) “1A”	37 in.	+1.0 in./-0.0 in.
(Typically OSP cable)		94 cm	+2.5 cm/-0.0 cm
Cable(s) “2B”	Same length as cable(s) “1B”	29 in.	+1.0 in./-0.0 in.
(Typically OSP cable)		74 cm	+2.5 cm/-0.0 cm

► **Note:** It is recommended to use the maximum cut length of 96 in. (243.8 cm) for cable(s) “1A”. Shorter lengths may be necessary for larger cable count and larger cable diameters.

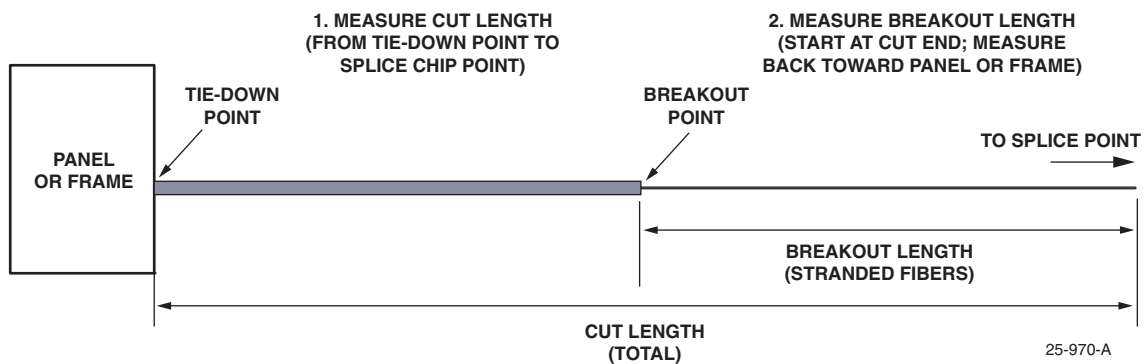

Figure 12. Fiber Lengths

5.1 Clockwise Roll-Up Procedure (24-Fiber, Heat Shrink Splice Configuration)

5.1.1 Cable(s) "1A" and "1B" (Typically IFC Cable)

After removing the top and bottom covers, route cable(s) "1A" and cable(s) "1B" simultaneously as follows:

1. Route the cable so the fiber breakout is positioned at the transition point from top to bottom (refer to the "circled 1" in Figure 13). Then route and tie down cable(s) "1A" as shown in Figure 13. (Cable(s) "1B", not shown, is routed simultaneously in the same manner.)

► **Note:** The circled numbers shown in Figure 13, Figure 14, and Figure 15 are provided as an orientation aid when flipping the cable over.

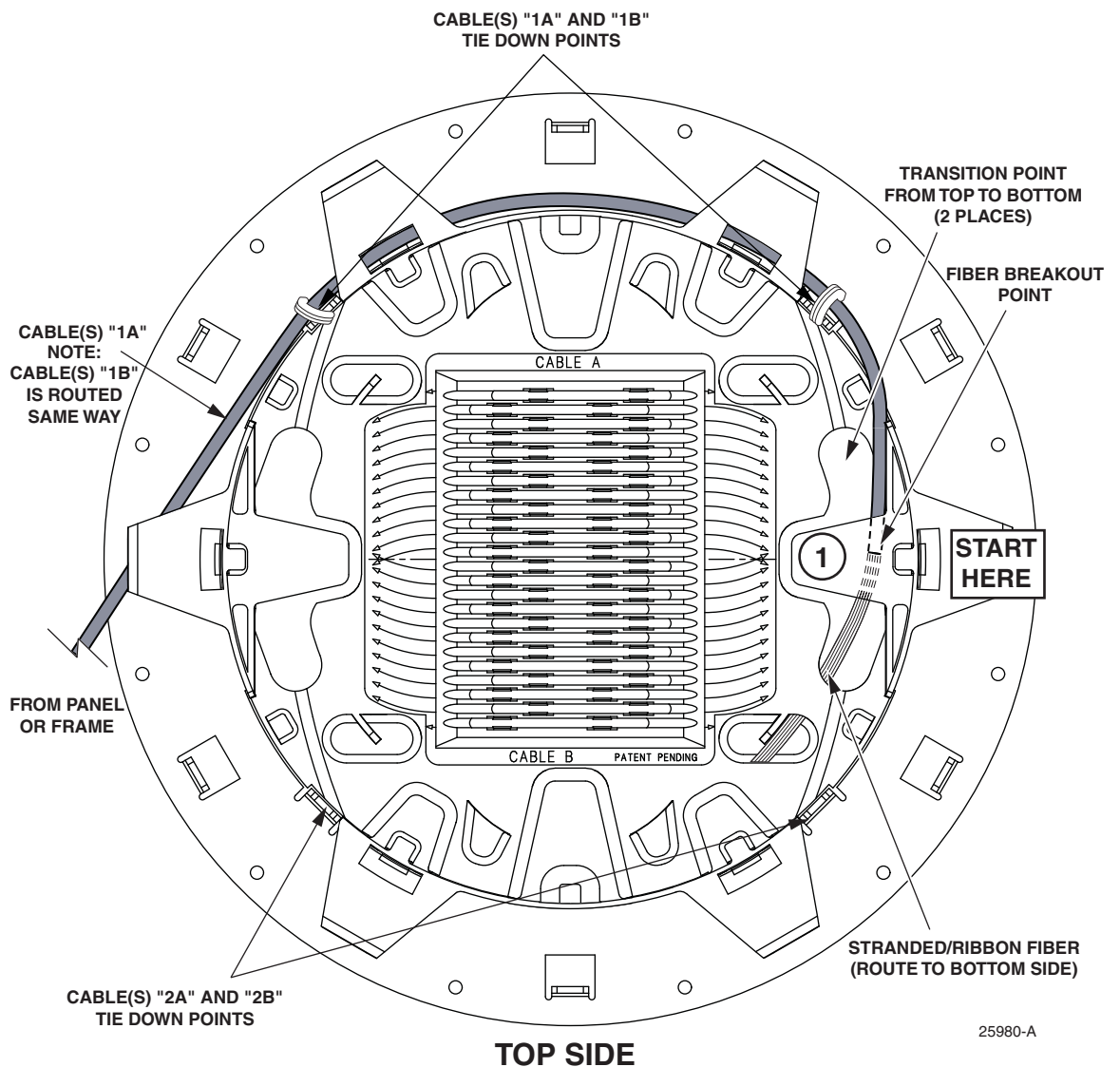

Figure 13. Cable "1A" Routing, Top Side (Clockwise Roll-Up Procedure)

2. Flip the tray over and continue routing cable(s) "1A" and "1B" around the spools and back to the top side, as shown in Figure 14. After routing cable(s) "1A" and cable(s) "1B" on bottom side, replace bottom cover.

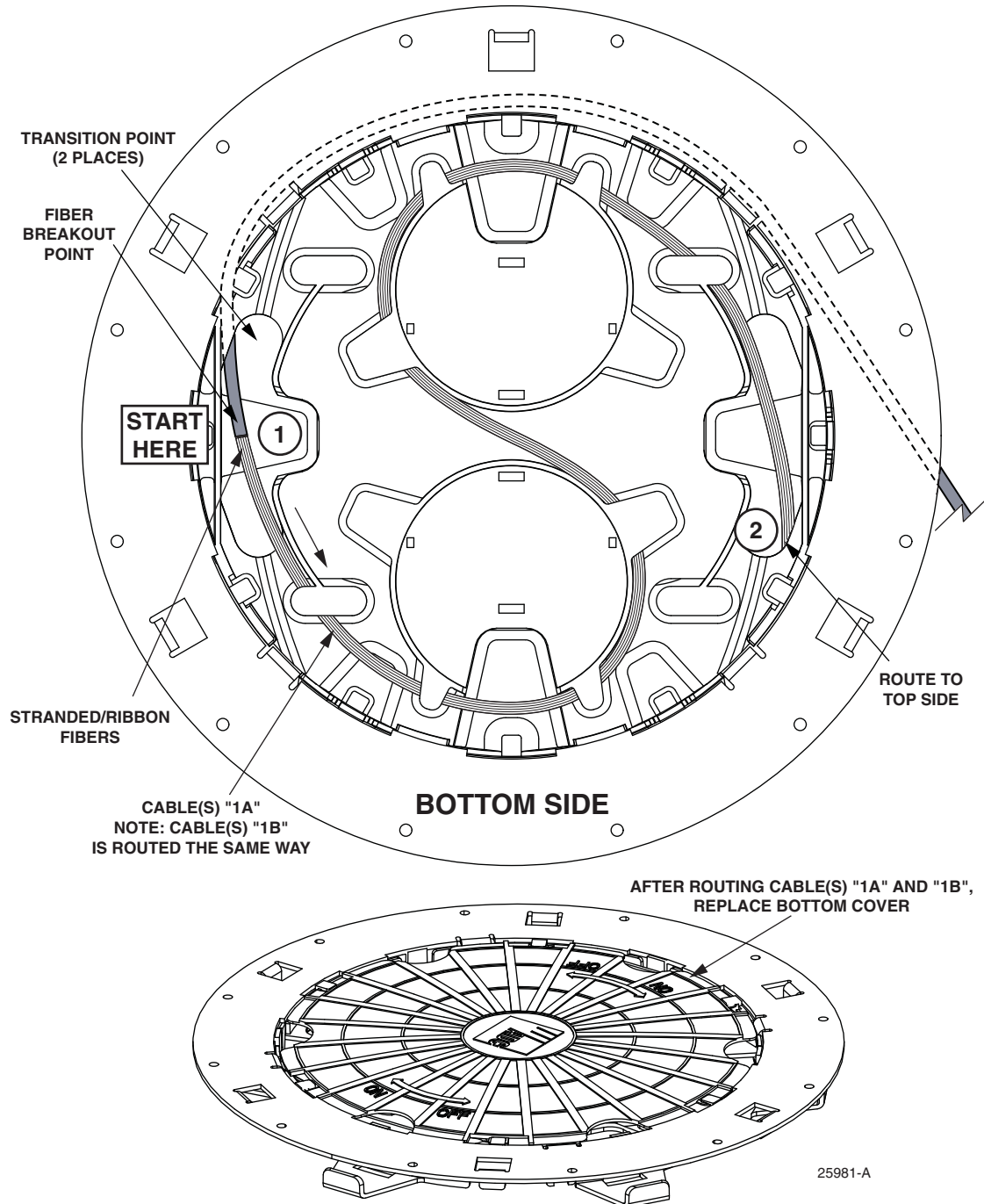

Figure 14. Cable(s) "1A" Routing, Bottom Side (Clockwise Roll-Up Procedure), continued

3. Flip the tray over to the top side and route cable(s) "1A" and cable(s) "1B" to the splice tray area as shown in Figure 15. Route cable(s) "1A" 1.5 times (cable(s) "1B" one time) around the inside of the tray making the loop as large as possible to ensure maximum fiber storage.

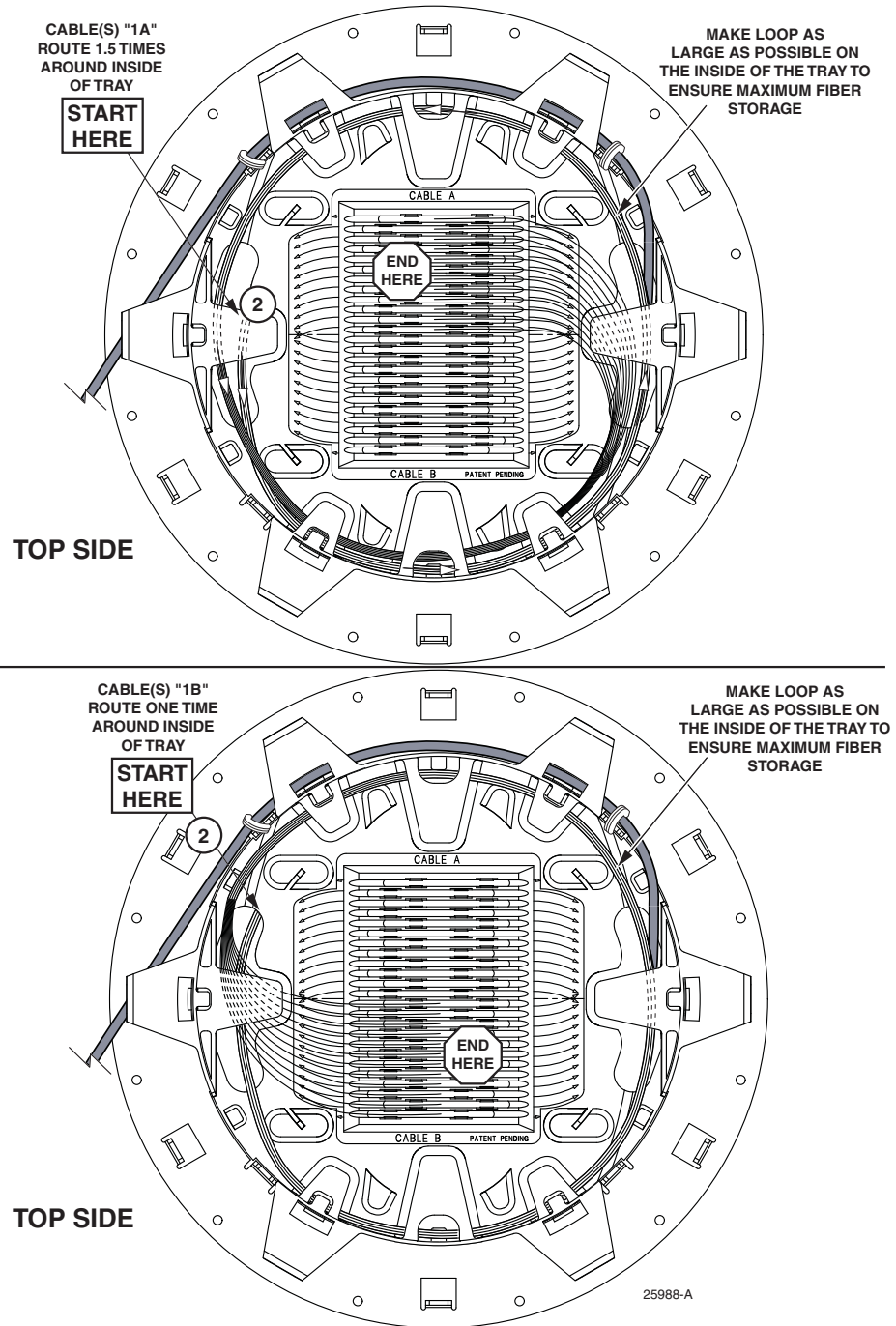

Figure 15. Cable(s) "1A" (Upper View) and Cable(s) "1B" (Lower View) Clockwise Roll-Up Procedure, continued

5.1.2 Cable(s) “2A” and “2B” (Typically OSP Cable)

After routing cable(s) “1A” and “1B”, route and tie down cable(s) “2A” and “2B” simultaneously on the top side of the cable tray as shown in Figure 16. Make sure to route cable(s) “2A” two times (“2B” 1.5 times) around the inside of the tray making the loop as large as possible to ensure maximum fiber storage.

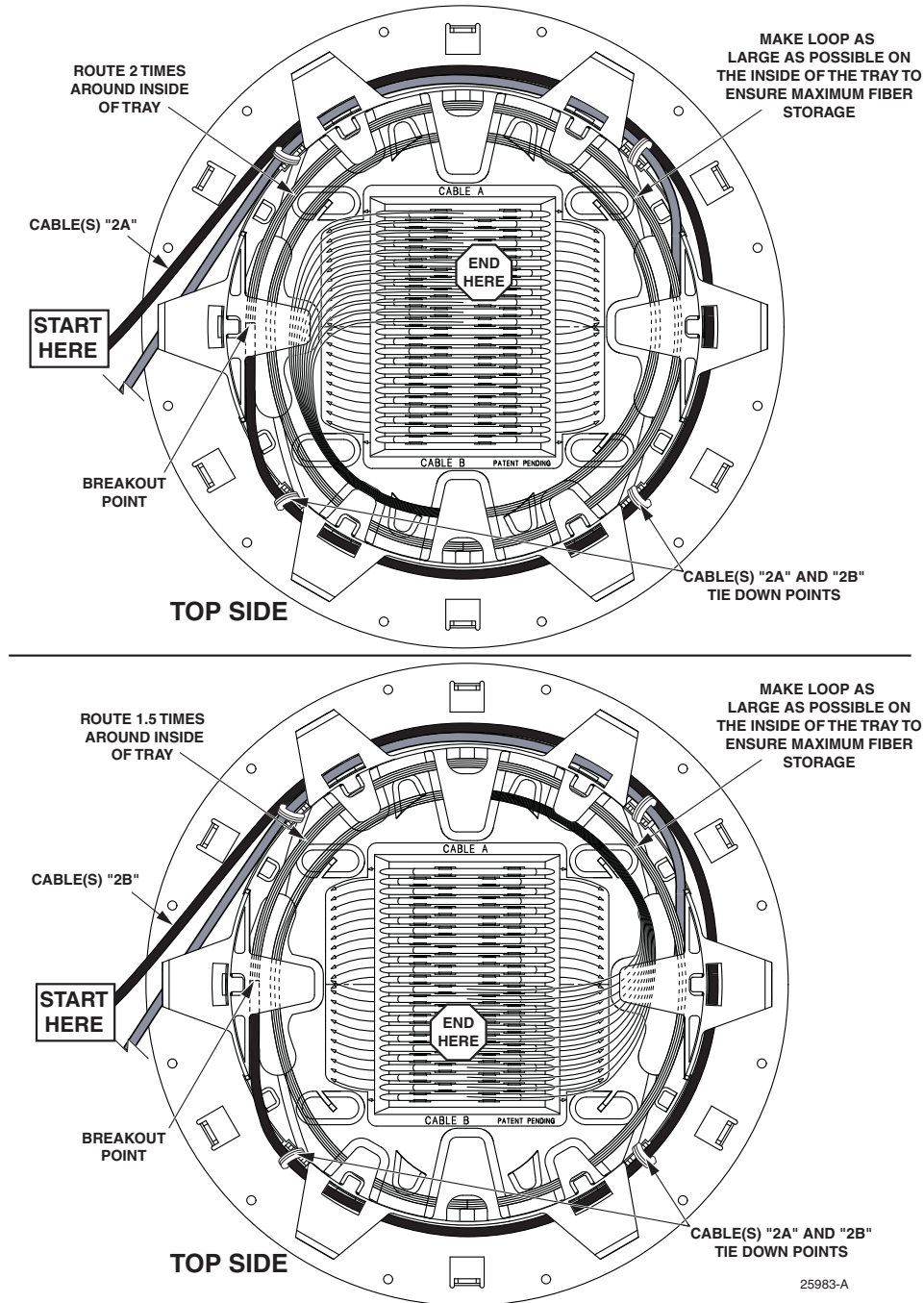

Figure 16. Cable(s) “2A” (Upper View) and “2B” (Lower View) Clockwise Roll-Up Procedure

5.2 Counter-Clockwise Roll-Up Procedure (24-Fiber, Heat Shrink Splice Configuration)

5.2.1 Cable(s) "1A" and "1B" (Typically IFC Cable)

► **Note:** Refer to Table 2 for cable description and fiber lengths.

After removing the top and bottom covers, route cable(s) "1A" and cable(s) "1B" (not shown) simultaneously as follows:

1. Route the cable so the fiber breakout is positioned at the transition point from top to bottom (refer to the "circled 1" in Figure 17). Then route and tie down cable(s) "1A" as shown in Figure 17. (Cable(s) "1B", not shown, is routed simultaneously in the same manner.)

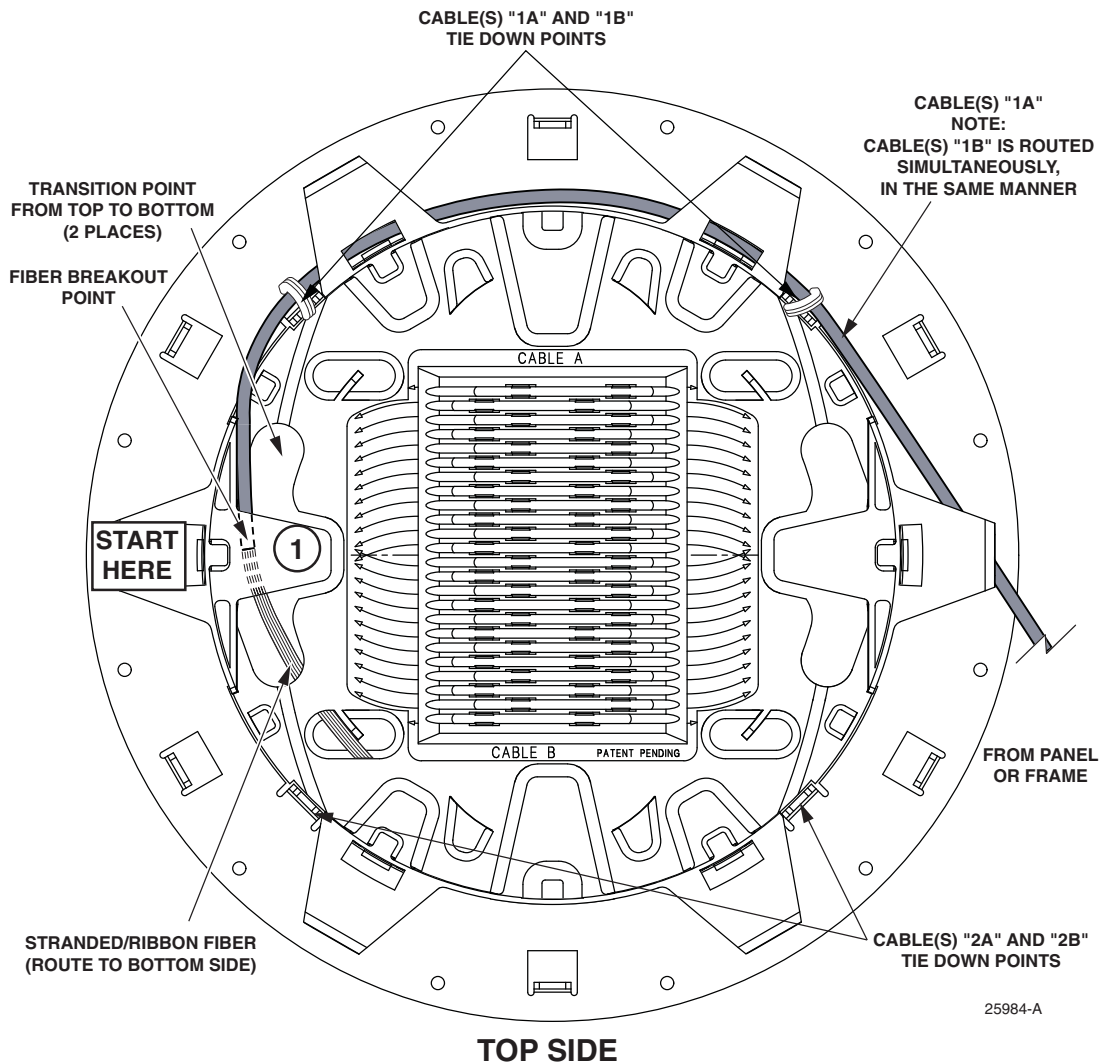

Figure 17. Cable(s) "1A" Routing, Top Side (Counter-Clockwise Roll-Up Procedure)

- Flip the tray over and continue routing cable(s) "1A" (and "1B") around the spools and back to the top side, as shown in Figure 18. After routing cable(s) "1A" and cable(s) "1B" on bottom side, replace bottom cover.

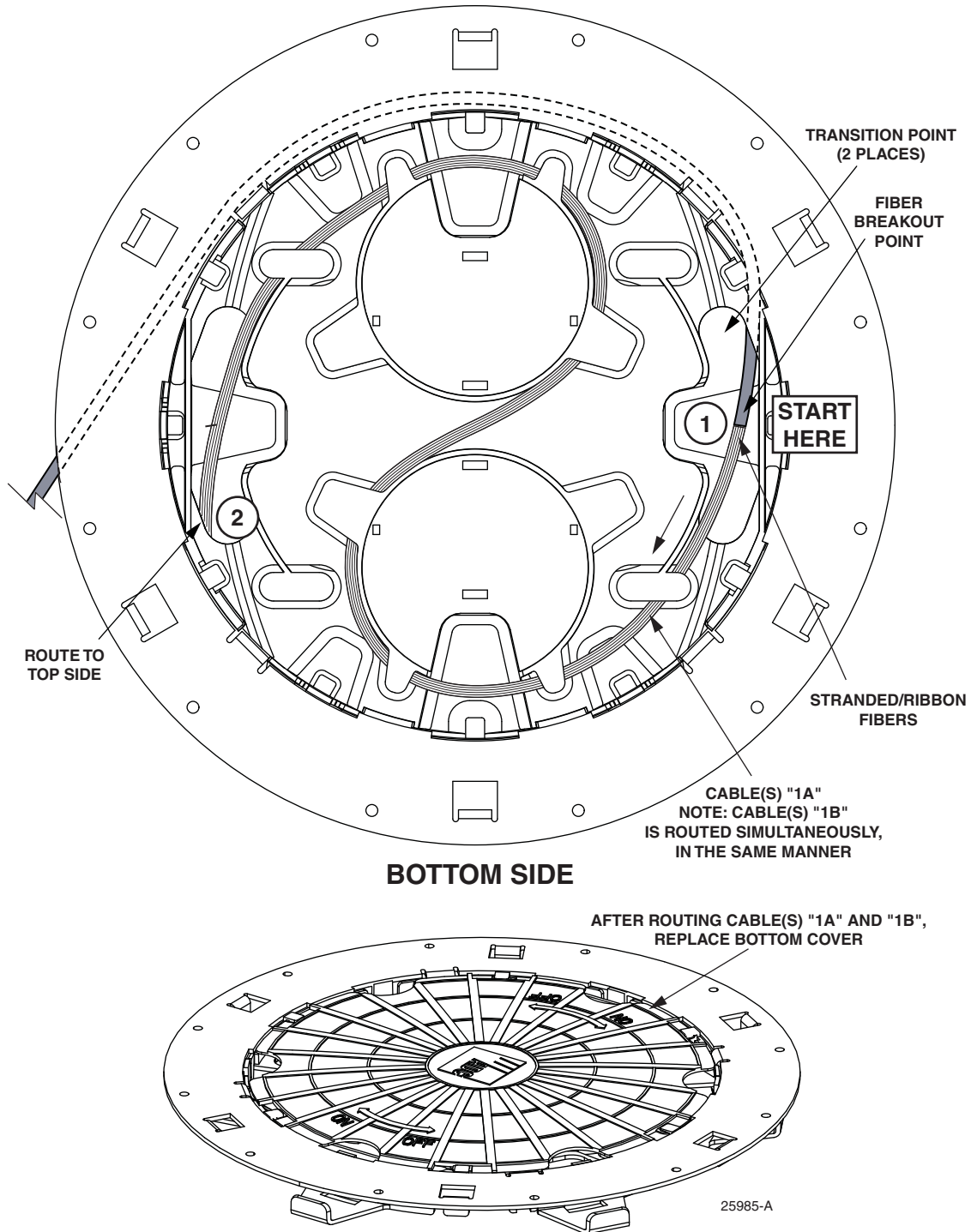

Figure 18. Cable(s) "1A" Routing, Bottom Side (Counter-Clockwise Roll-Up Procedure), continued

- Flip the tray over to the top side and route cable(s) “1A” (upper view) and cable(s) “1B” (lower view) to the splice tray area, as shown in Figure 19. Route cable(s) “1A” 1.5 times (cable(s) “1B” one time) around the inside of the tray making the loop as large as possible to ensure maximum fiber storage.

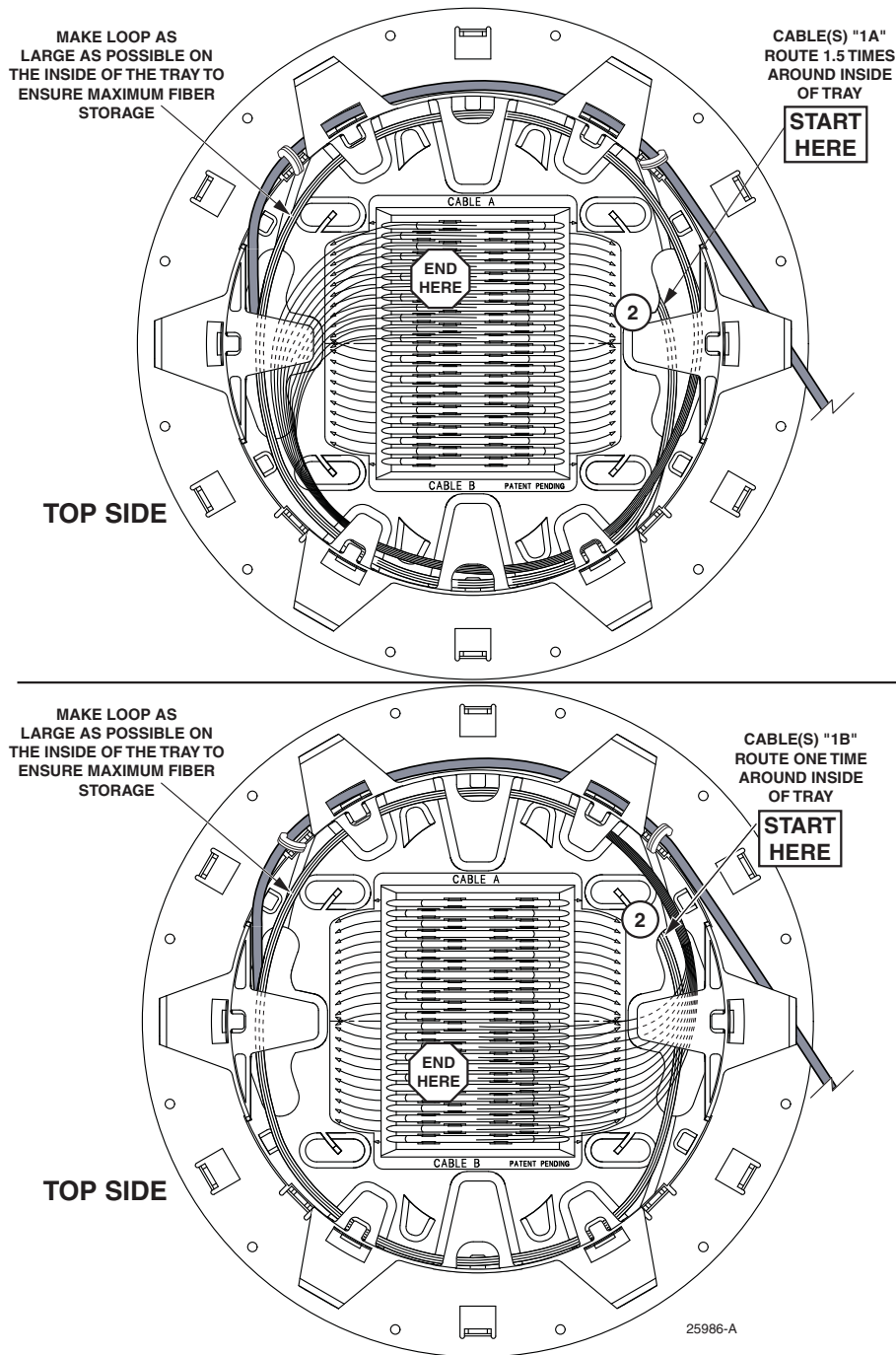

Figure 19. Cable(s) “1A” (Upper View) and Cable(s) “1B” (Lower View) Counter-Clockwise Roll-Up, continued

5.2.2 Cable(s) “2A” and “2B” (Typically OSP Cable)

After routing cable(s) “1A” and “1B”, route cable(s) “2A” and “2B” simultaneously on the top side of the cable tray, as shown in Figure 20. Make sure to route cable(s) “2A” two times (“2B” 1.5 times) around inside of tray making loop as large as possible to ensure maximum fiber storage.

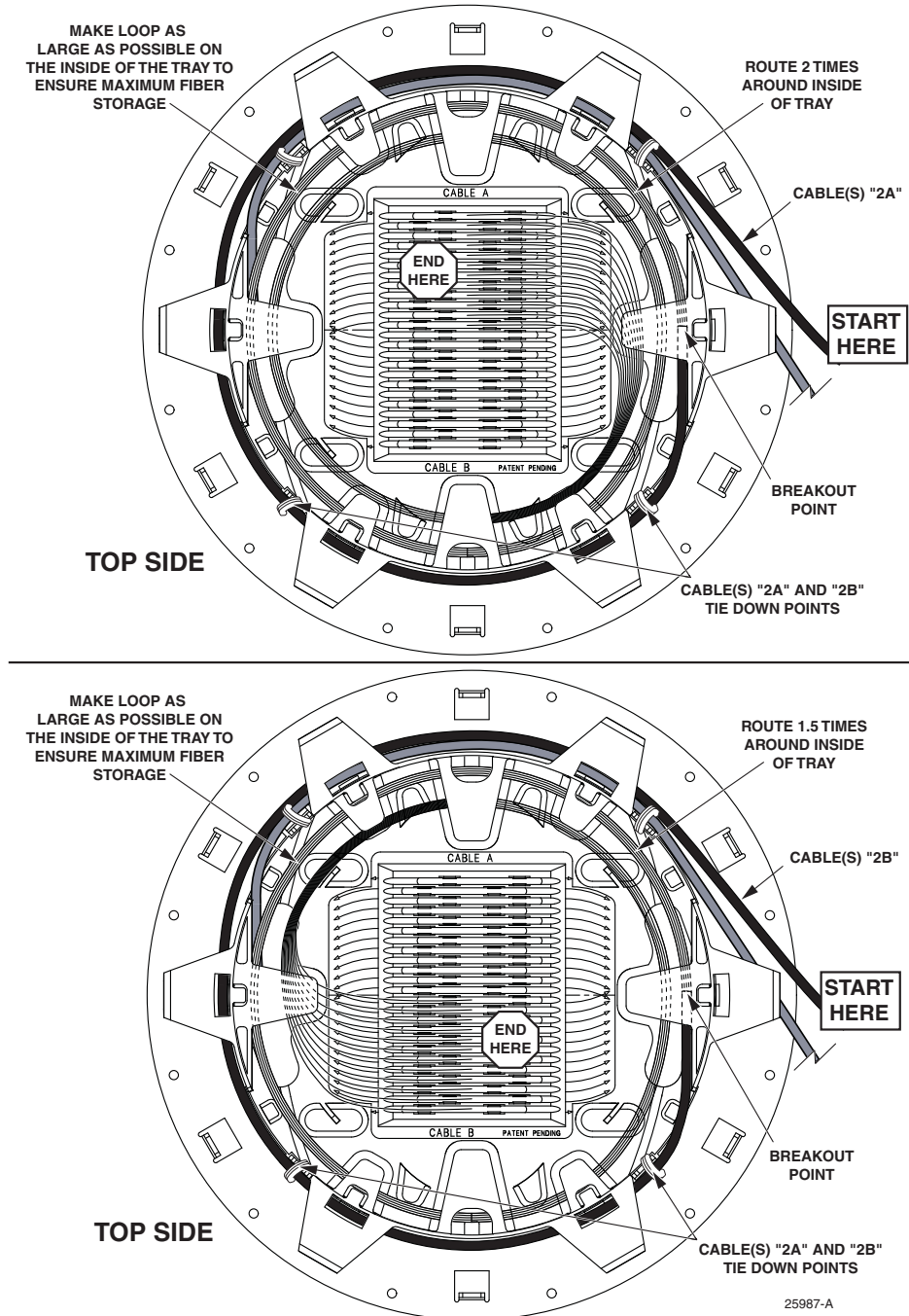

Figure 20. Cable(s) “2A” (Upper View) and “2B” (Lower View) Counter-Clockwise Roll-Up Procedure

6 CABLE ROUTING (4 STACKED RIBBONS USING OVAL-TUBING BREAKOUT KITS)

Route cables “1A and 1B” and cables “2A and 2B” to their designated panel and secure them to the panel or frame (tie down point) according to local practice. After securing the cables, proceed as follows:

1. Starting at the tie down location on the panel or frame, measure and mark the cut length. See [Table 3](#).
2. Cut the cable at the cut length mark.
3. Starting at the stub end of the cable, measure backwards (right-to-left, see [Figure 21](#)) and mark the breakout length (refer to [Table 3](#)). Remove outer jacket to expose the ribbon fibers. (Remove any moisture blocking compound from OSP fibers.)

Table 3. Fiber Ribbon Lengths

CABLE	CUT LENGTH	BREAKOUT LENGTH	TOLERANCE
Cable(s) “A”	68 in. (minimum) to 146 in. (maximum)	48 in.	+1.0 in. –0.0 in.
(Typically IFC cable)	172.7 cm (minimum) to 370.8 cm (maximum)	122 cm	+2.5 cm –0.0 cm
Cable(s) “B”	1 inch longer than cable “A”	48 in.	+1.0 in. –0.0 in.
(Typically OSP cable)		122 cm	+2.5 cm –0.0 cm

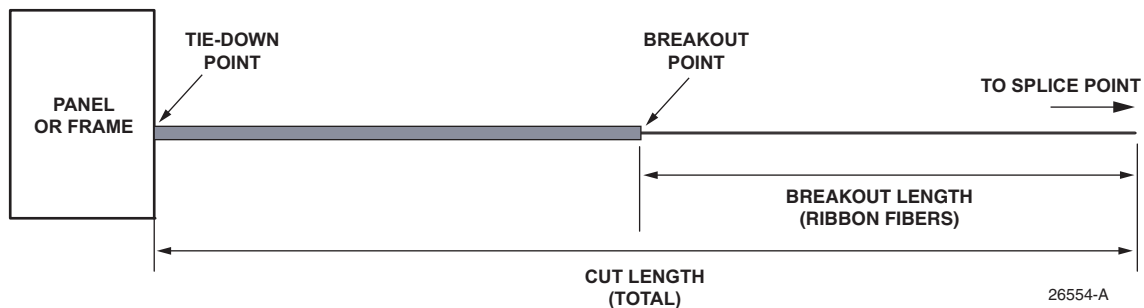

Figure 21. Fiber Ribbon Lengths

- **Note:** For best performance, allow room for fiber movement within the splice wheel, where applicable. When using an FST-DRS* series splice wheel, and stacking more than two ribbons, there is a chance that the ribbon on the inner diameter can experience loss. This is due to the shorter distance traveled by the inner ribbon for every revolution the oval tubing is wrapped around the splice wheel. **(continued next page)**

- ▶ **Note: (continued from previous page)** To eliminate or reduce the possibility of loss caused by the shorter distance traveled it is important to alternate which ribbon is on the inner track when wrapping the oval tubing on the splice wheel. Prior to wrapping the oval tube around the splice wheel for storage, apply a 720 degree twist to the oval tubing in the following step.
- 4. Hold the splice wheel with the oval tubing fully extended and with the cabinet to your right. Flip the splice wheel so the edge closest to you moves up and away four times for two complete 360 degree twists.
- ▶ **Note:** When rolling the oval tubes up on the FST-DRS* series splice wheel installers should provide some vibration after every half revolution of wrapping to assist in the movement of the excess ribbon length to the splice wheel and away from the break out area.
- 5. Hold the splice wheel in one hand and using the other hand provide a small shock on the splice wheel via a clapping motion eight to ten times for every half revolution the oval tubes are wrapped around the wheel.
- ▶ **Note:** Wrap no more than 2.5 revolutions or 54 inches of tubing around the FST-DRS* series splice wheel if more than 2 ribbons (12 or 24) are in a tube.

6.1 Clockwise Roll-up Procedure (4 Stacked Ribbons per Oval Tube)

1. Put cable “A” (typically the IFC cable) on the inside and cable “B” (typically the OSP cable) on the outside. Note the orientation of the cables. Align the end of the oval tubes in the area shown in [Figure 22](#).
2. Route cable “B” ribbons two revolutions and cut.
3. Route cable “A” ribbons one and a half revolutions and cut.

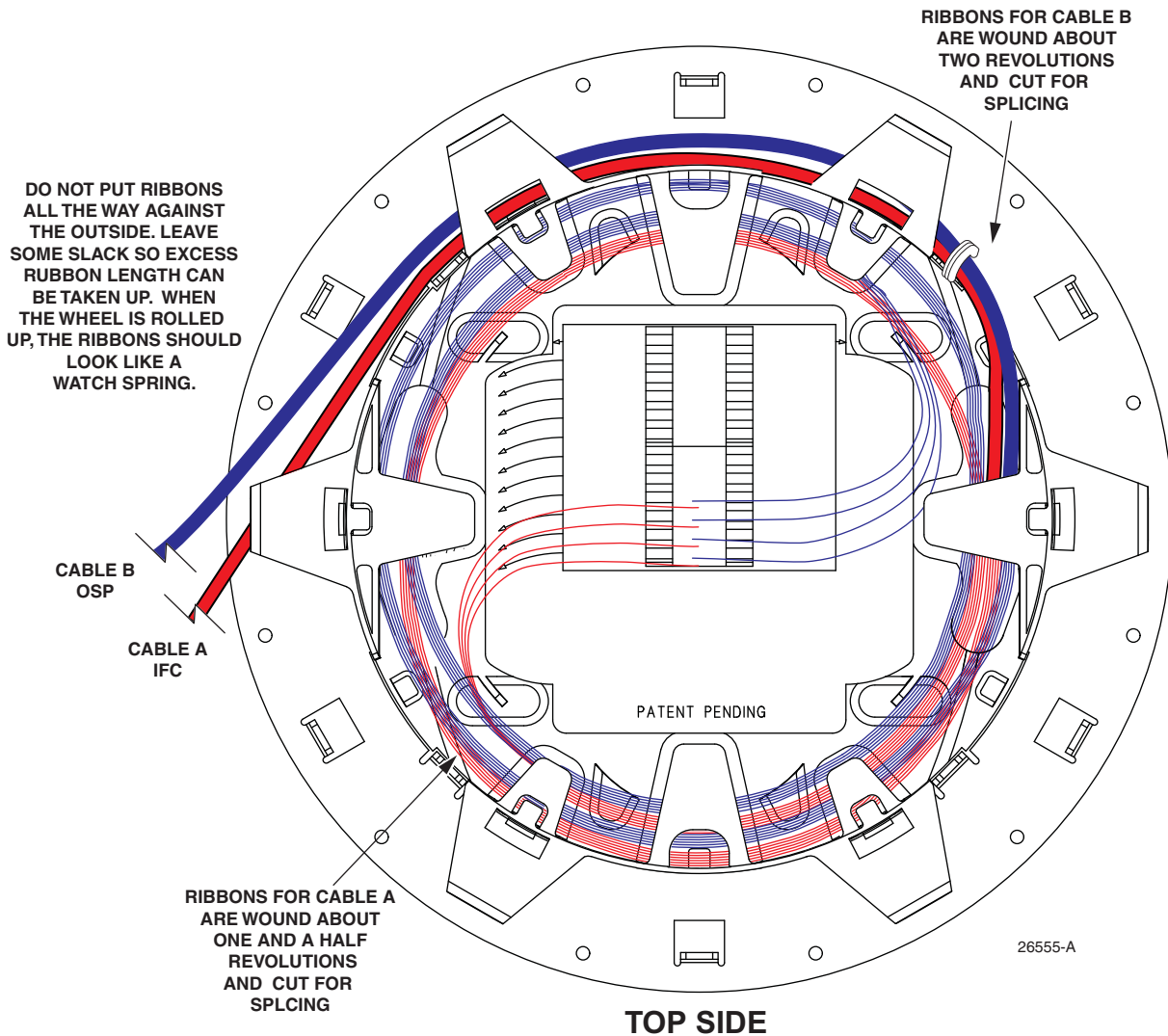

Figure 22. Clockwise Roll-up (4 Stacked Ribbons per Oval Tube)

6.2 Counter-Clockwise Roll-up Procedure (4 Stacked Ribbons per Oval Tube)

1. Put cable “A” (typically the IFC cable) on the inside and cable “B” (typically the OSP cable) on the outside. Note the orientation of the cables. Align the end of the oval tubes in the area shown in [Figure 23](#).

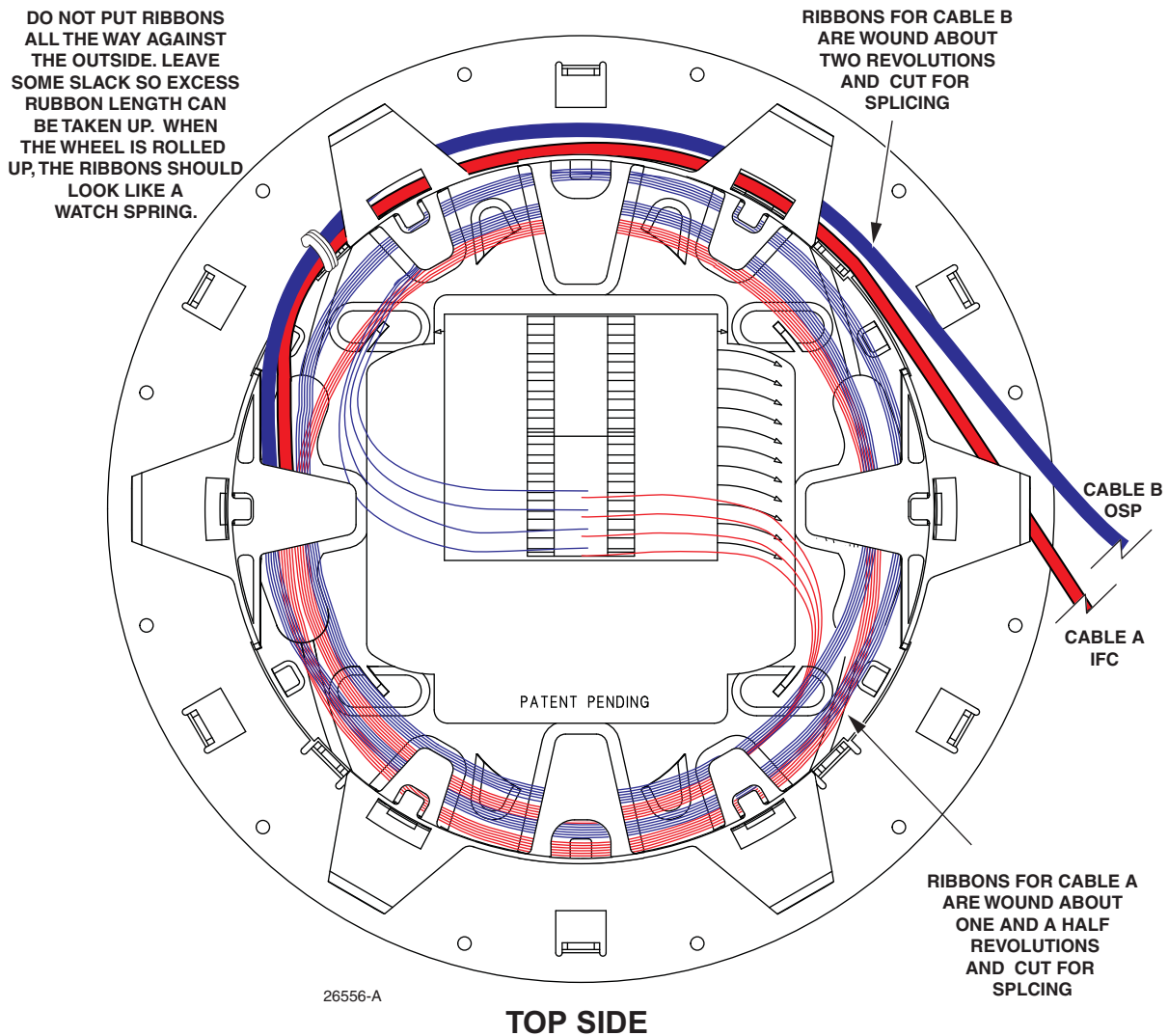

Figure 23. Counter-Clockwise Roll-up (4 Stacked Ribbons per Oval Tube)

2. Route cable “B” ribbons two revolutions and cut.
3. Route cable “A” ribbons one and a half revolutions and cut.

7 CABLE ROUTING (USING RIBBONS WITH MESH SLEEVE)

7.1 Standard Ribbon Application

Access this QR code with a smart phone to view videos of OMX Splice Bay procedures,



When the IFC cable and OSP cable are of standard ribbon construction, the ribbons from both cables are routed entirely on the top side of the splice reel. Route the IFC and OSP cables to their designated clamping or tie down location and secure them to the panel or frame following the instructions provided in the user guide for that panel or bay. After securing the cables, proceed as follows:

1. Refer to the user guide for the panel or frame to determine the breakout lengths to be used between the cable clamping or tie down location and the Round Splice Tray. Break out the cable corresponding to the directions provided and install the mesh sleeve on the ribbons designated for the tray being installed.
- ▶ **Note:** For the OMX Splice Bay high density application, refer to the breakout lengths and diagrams provided in CommScope publication TC-96219-IP.
2. Refer to [Table 4](#) to determine the length of exposed ribbon fiber required for the Round Splice Tray. This is the length wound within the tray.

Table 4. Fiber Ribbon Lengths

CABLE	BREAKOUT LENGTH	TOLERANCE
OSP	75 in.	+1.0 in./ -0.0 in.
	191 cm	+2.5 cm /-0.0 cm
IFC	48 in.	+1.0 in./-0.0 in.
	221 cm	+2.5 cm/-0.0 cm

3. Note that the point where the mesh sleeve ends and the bare ribbon fiber begins is the point where the mesh sleeve is secured to the splice tray. This is true of both the IFC and the OSP cable in this application.
4. Prepare the mesh sleeve for the cable tie by installing a piece of felt tape at the end of the mesh sleeve where it will be under the cable tie. The cable tie is secured on the felt tape. The felt tape prevents the mesh sleeve from slipping under the cable tie.
5. Secure the mesh sleeve and route the ribbons as shown in the next two sections.
- ▶ **Note:** For best performance, allow room for fiber movement within the splice wheel, where applicable. When stacking more than two ribbons, there is a chance that the ribbon on the inner diameter can experience loss. This is due to the shorter distance traveled by the inner ribbon for every revolution the mesh sleeve is wrapped around the splice wheel. To eliminate or reduce the possibility of loss caused by the shorter distance traveled, alternate which ribbon is on the inner track when wrapping the mesh sleeve on the splice wheel. Prior to wrapping the mesh sleeve around the slice wheel, for storage, apply a 720 degree twist to the mesh sleeve in the following step.

6. Hold the splice wheel with the mesh sleeve fully extended and with the cabinet to your right. Flip the splice wheel so the edge closest to you moves up and away four times for two complete 360 degree twists.

7.1.1 Clockwise Roll-up Procedure (Using Traditional Ribbons Matrix With Mesh Sleeve)

1. Secure the OSP cable to the Round Splice Tray as follows:
 - a. Apply a piece of felt tape at the juncture of the mesh sleeve and the ribbon fiber on both OSP and IFC cables.
 - b. Install an open cable tie in the tray at the location shown.
 - c. Position the IFC cable to the inside of the OSP cable on the splice tray.
 - d. Place the felt tape on both OSP and IFC mesh sleeves together, place it in the cable tie, and secure the cable tie.

► **Note:** DO NOT OVERTIGHTEN THE CABLE TIE.

- e. Route OSP ribbons two revolutions clockwise and cut.
 - f. Route IFC ribbons one and a half revolutions clockwise and cut.
2. Prepare and splice fibers. Splice all fibers first before placing finished splices into splice chip. Bundle all ribbons at the sleeve/ribbon junction point and carefully route bundle around the inside of splice tray. Place splices into splice chip using the center most tray locations. See [Figure 24](#).

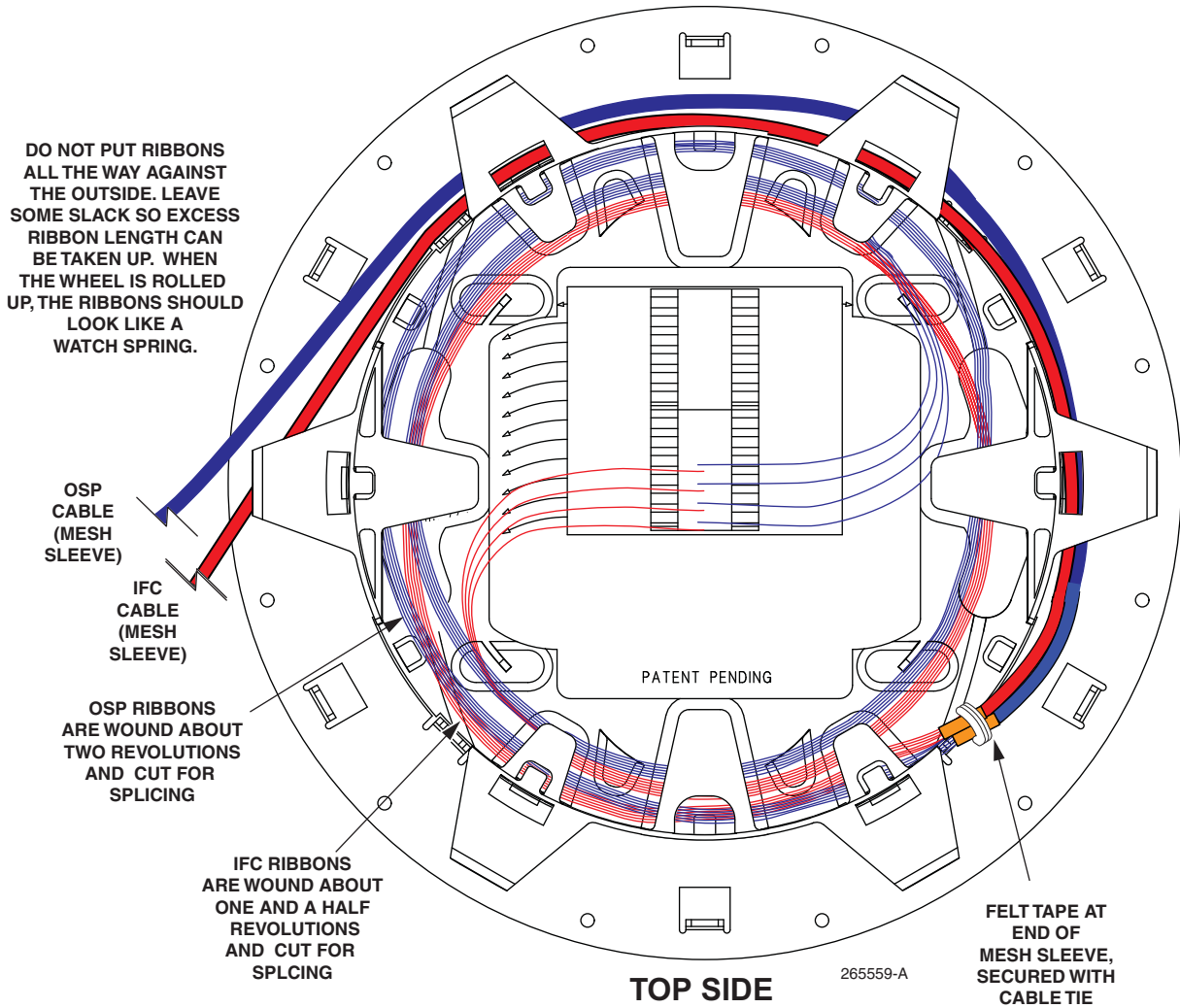

Figure 24. Clockwise Roll-up (4 Stacked Traditional Ribbons Matrix per Tube)

7.1.2 Counter-Clockwise Roll-up Procedure (sing Traditional Ribbons Matrix With Mesh Sleeve)

1. Secure the OSP cable to the Round Splice Tray as follows:
 - a. Apply a piece of felt tape at the juncture of the mesh sleeve and the ribbon fiber on both OSP and IFC cables.
 - b. Install an open cable tie in the tray at the location shown.
 - c. Position the IFC cable to the inside of the OSP cable on the splice tray.
 - d. Place the felt tape on both OSP and IFC mesh sleeves together, place it in the cable tie, and secure the cable tie.
- ▶ **Note:** DO NOT OVERTIGHTEN THE CABLE TIE.
 - e. Route OSP ribbons two revolutions counter-clockwise and cut.
 - f. Route IFC ribbons one and a half revolutions counter-clockwise and cut.
2. Prepare and splice fibers. Splice all fibers first before placing finished splices into splice chip. Bundle all ribbons at the sleeve/ribbon junction point and carefully route bundle around the inside of splice tray. Place splices into splice chip in using the center most tray locations. See [Figure 25](#).

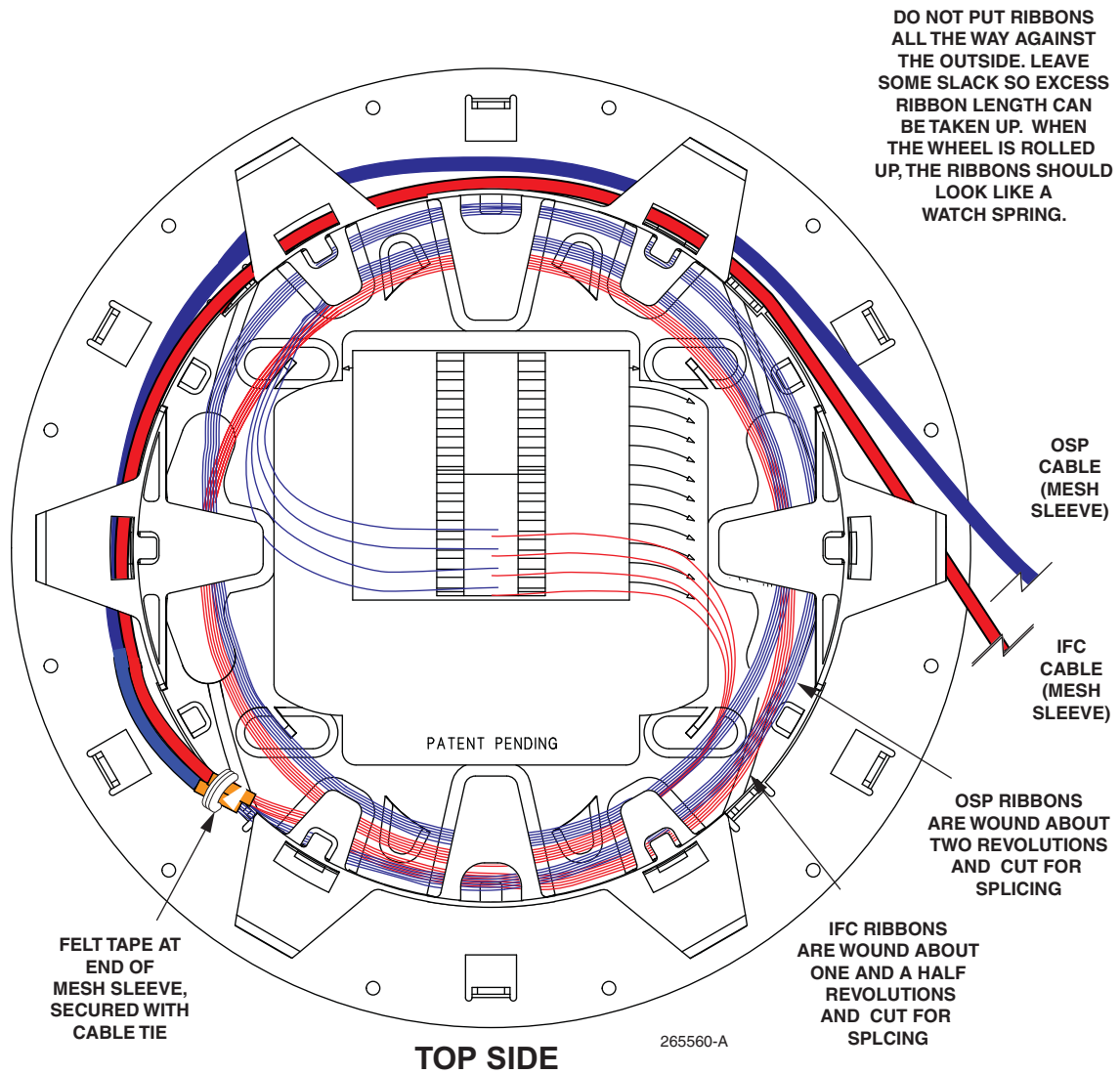

Figure 25. Counter-Clockwise Roll-up (4 Stacked Traditional Ribbons Matrix per Tube)

7.2 Procedure Used When OSP Cable is of Pliable Ribbon Construction

When the IFC cable is of standard ribbon construction and the OSP cable is of pliable ribbon construction, both sides of the tray are used. The OSP pliable ribbons are secured on the top side of the tray and routed to the bottom side to be re-routed in a reverse wind direction, then they are routed to the top side again and into the splice chip. The IFC standard construction ribbons are secured and routed entirely on the top side of the tray.

Route the IFC and OSP cables to their designated clamping or tie down location and secure them to the panel or frame following the instructions provided in the user guide for that panel or bay. After securing the cables, proceed as follows:

1. Refer to the user guide for the panel or frame to determine the breakout lengths to be used between the cable clamping or tie down location and the Round Splice Tray. Break out the cable corresponding to the directions provided and install the mesh sleeve on the ribbons designated for the tray being installed.
- ▶ **Note:** For the OMX Splice Bay high density application, refer to the breakout lengths and diagrams provided in CommScope publication TC-96219-IP.
2. Refer to [Table 5](#) to determine the length of exposed ribbon fiber required for the Round Splice Tray. This is the length that is wound within the tray.

Table 5. Fiber Ribbon Lengths

CABLE	BREAKOUT LENGTH	TOLERANCE
OSP	75 in.	+1.0 in./ -0.0 in.
	191 cm	+2.5 cm /-0.0 cm
IFC	48 in.	+1.0 in./-0.0 in.
	221 cm	+2.5 cm/-0.0 cm

3. Note that the point where the mesh sleeve ends and the bare ribbon fiber begins is the point where the cables (both IFC and OSP) are secured to the tray.
4. Prepare the cable for the cable tie by installing a piece of felt tape at the end of the mesh sleeve where it will be under the cable tie. The cable tie is secured on the felt tape. The felt tape prevents the mesh sleeve from slipping under the cable tie.
- ▶ **Note:** DO NOT OVERTIGHTEN THE CABLE TIE.
5. Secure the cables and route the ribbons as shown in the next two sections.
- ▶ **Note:** For best performance, allow room for fiber movement within the splice wheel, where applicable. When stacking more than two ribbons, there is a chance that the ribbon on the inner diameter can experience loss. This is due to the shorter distance traveled by the inner ribbon for every revolution the mesh sleeve is wrapped around the splice wheel. To eliminate or reduce the possibility of loss caused by the shorter distance traveled, alternate which ribbon is on the inner track when wrapping the mesh sleeve on the splice wheel. Prior to wrapping the mesh sleeve around the splice wheel for storage, apply a 720 degree twist to the mesh sleeve in the following step.

6. Hold the splice wheel with the mesh sleeve fully extended and with the cabinet to your right. Flip the splice wheel so the edge closest to you moves up and away four times for two complete 360 degree twists.
- ▶ **Note:** When rolling the mesh sleeves up on the FST-DRS* series splice wheel installers should provide some vibration after every half revolution of wrapping to assist in the movement of the excess ribbon length to the splice wheel and away from the break out area.
7. Hold the splice wheel in one hand and using the other hand provide a small shock on the splice wheel via a clapping motion eight to ten times for every half revolution the mesh sleeves are wrapped around the wheel.

7.2.1 OSP Cable With Pliable Ribbon

- ▶ **Note:** The figures in this section show clockwise routing. Counterclockwise routing is the mirror image of the shown routing.

After removing the top and bottom covers, route the cable as follows:

1. Position the cable so the fiber breakout is positioned at the transition point from top to bottom (just beyond felt tape shown in Figure 27. Then route and tie down the fibers as shown in Figure 27.

- ▶ **Note:** The circled numbers shown in Figure 27 and Figure 28 are provided as an orientation aid when flipping the cable tray over.

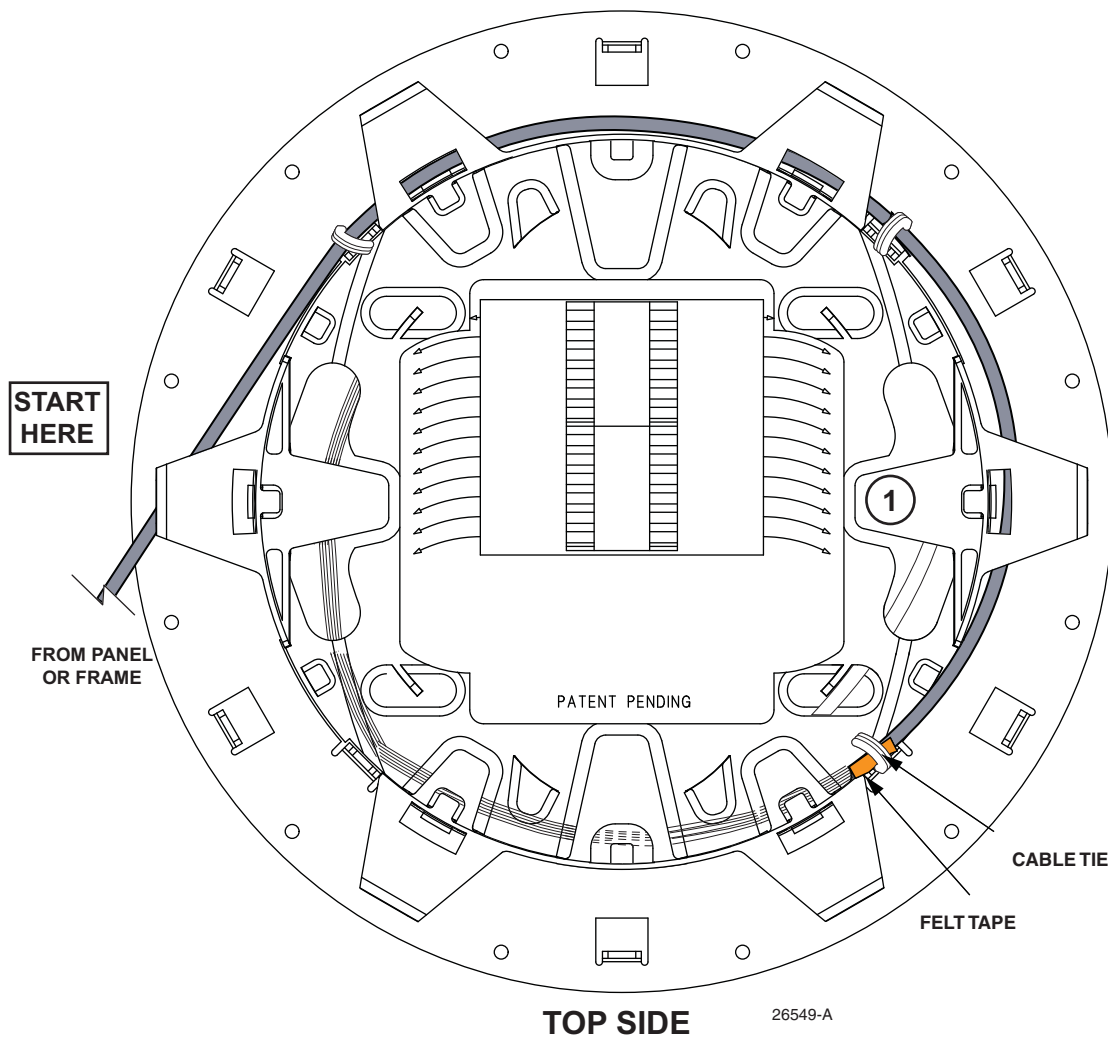

Figure 26. Pliable Fiber Routing, Top Side (Clockwise Roll-Up Procedure)

2. Flip the tray over and continue routing the pliable fibers around the spools and back to the top side, as shown in Figure 27. After routing on bottom side, replace bottom cover.

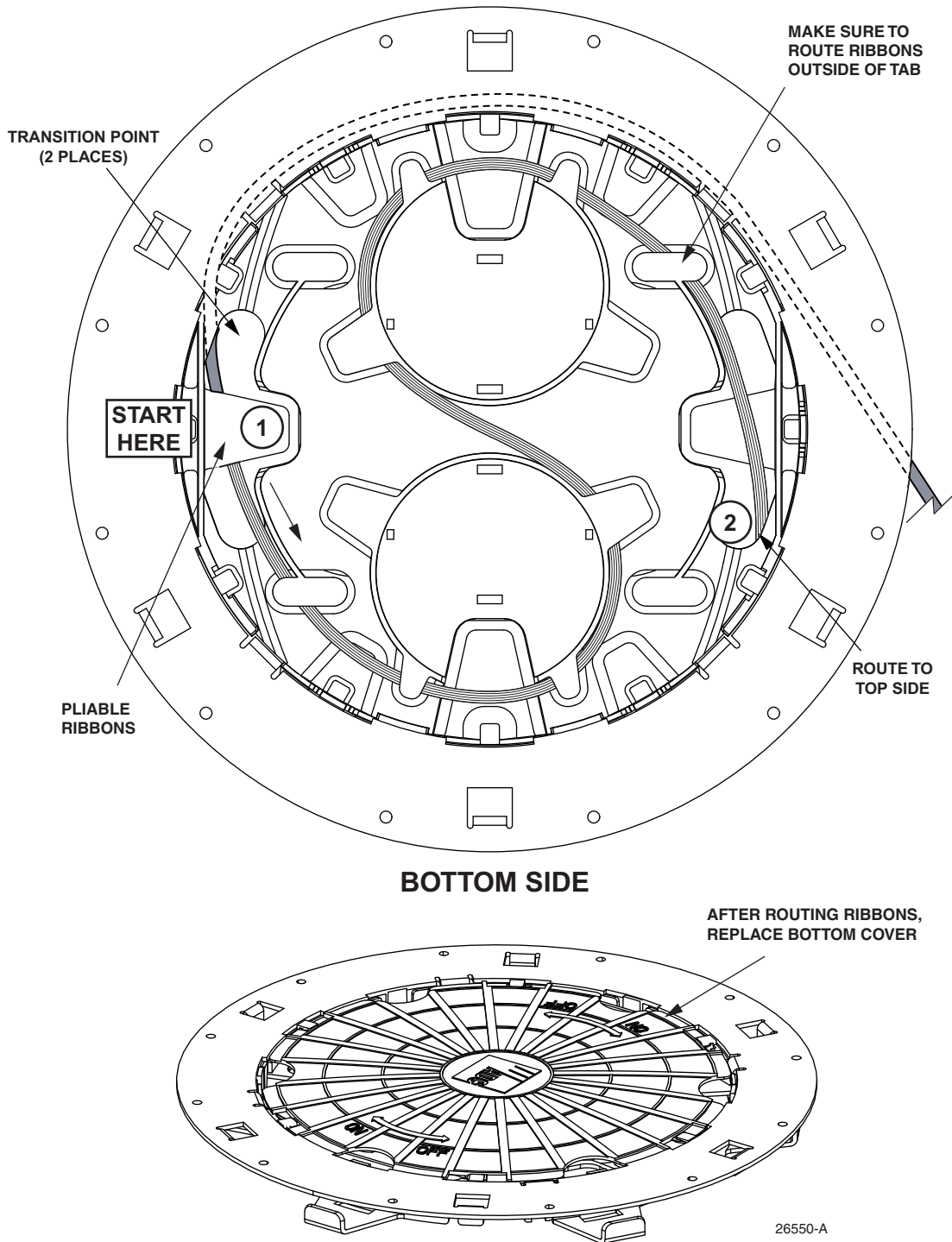

Figure 27. Pliable Ribbon Routing, Bottom Side (Clockwise Roll-Up Procedure), continued

3. Flip the tray over to the top side and extend the fibers straight. Measure 22 inches and cut ribbons as shown in [Figure 28](#).
4. Route the fibers around the inside of the tray and into the splice chip.

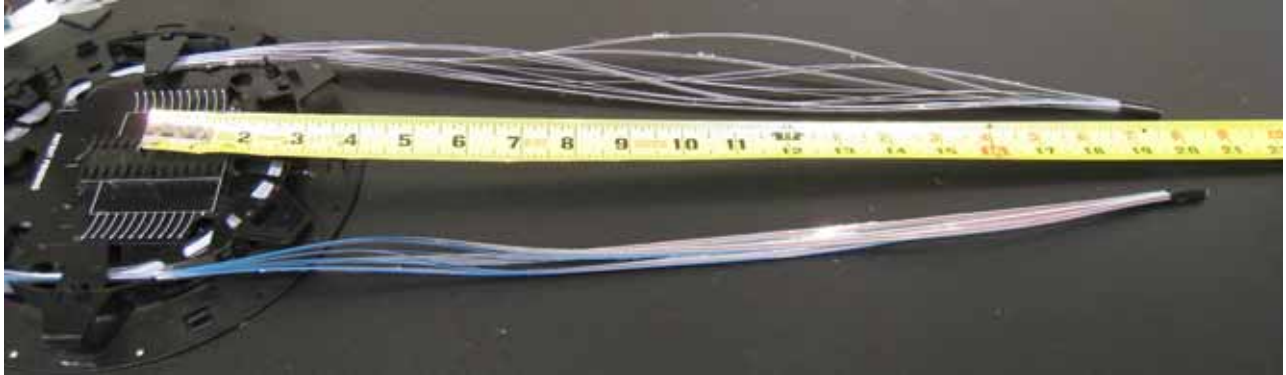

Figure 28. Measuring Pliable Fibers for Cutting

7.2.2 IFC Cable With Standard Ribbon

1. Route and tie down the IFC bundle on the top side of the cable tray.
2. Extend the fibers straight as shown in [Figure 28](#). Measure 22 inches and cut.
3. Route the fibers around the inside of the tray and into the splice chip.

7.2.3 Completing the Splice Tray

1. Prepare and splice fibers. Splice all fibers first before placing finished splices into splice chip.
2. Once all splices have been completed, together take all the splices and rotate them away from you 360 degrees to introduce a twist into the fibers. This twist will assist you in neatly dressing in the fibers into the splice wheel.
3. Place splice protectors in the splice chip and dress ribbons into the splice wheel. Install cover onto splice wheel making sure no fibers are pinched in the process.

8 CUSTOMER INFORMATION AND ASSISTANCE

<http://www.commscope.com/SupportCenter>