

# MT-216-6NS

---

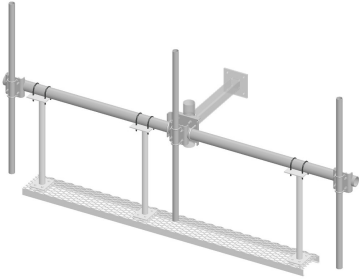

Cellular Pipe Frame, 6 ft face

## Product Classification

**Product Type** Pipe mount

## General Specifications

**Mounting** Pipe, 114.3 mm (4-1/2 in) OD

## Dimensions

**Height** 254 mm | 10 in

**Face Width** 1.981 m | 6.5 ft

**Width** 1,981.2 mm | 78 in

**Length** 88.9 mm | 3.5 in

# MT-216-6NS

## Outline Drawing

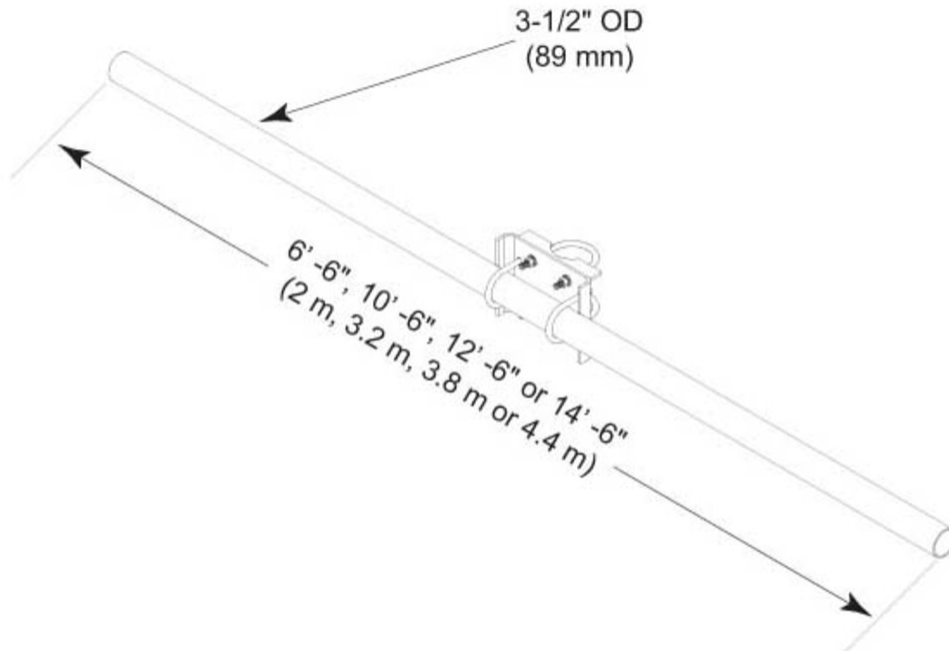

## Material Specifications

**Material Type** Hot dip galvanized steel

## Mechanical Specifications

**Wind Rating** 120 mph (BWS) at 150 ft AGL | 140 mph (3-second gust) at 150 ft AGL using Exposure D per FBC

**Wind Rating Criteria** Four 72 in x 8 in panel antennas per sector

**Wind Rating Test Method** TIA/EIA-222

## Packaging and Weights

**Included** Cellular pipe frames

**Packaging quantity** 1

**Weight, net** 22.8 kg | 50.265 lb

## Regulatory Compliance/Certifications

# MT-216-6NS

---

**Agency**

ISO 9001:2015

**Classification**

Designed, manufactured and/or distributed under this quality management system

\* Footnotes

**Wind Rating**

BWS—Base Wind Speed; FBC—Florida Building Code