

S-400

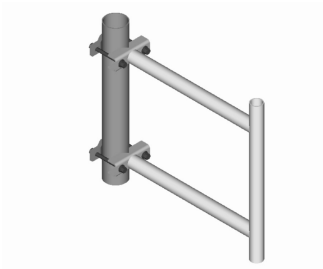

Stand-Off Bracket, 48 in, includes pipe

Product Classification

Product Type Stand-off mount

General Specifications

Mounting Straight or tapered legs up to 88.9 mm (3-1/2 in) OD, clamps included

Note One 20 ft omni antenna

Pipe, quantity 1

Tower Taper Non-tapered | Tapered

Dimensions

Height 812.8 mm | 32 in

Width 127 mm | 5 in

Length 1,219.2 mm | 48 in

Pipe Length 812.8 mm | 32 in

Pipe Outer Diameter 48.26 mm | 1.9 in

Stand-off Distance 1,219.2 mm | 48 in

S-400

Outline Drawing

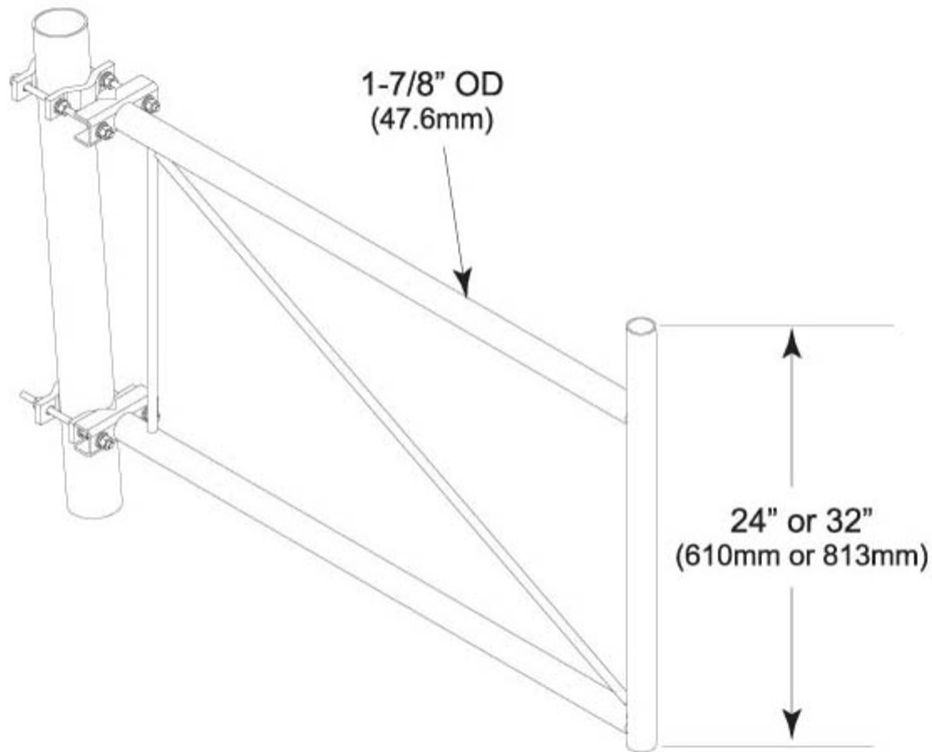

Material Specifications

Material Type Hot dip galvanized steel

Mechanical Specifications

Wind Rating 120 mph (BWS) at 150 ft AGL

Wind Rating Test Method TIA/EIA-222

Packaging and Weights

Included Clamps | Stand-off

Packaging quantity 1

Weight, net 18.6 kg | 41.006 lb

Regulatory Compliance/Certifications

Agency **Classification**

S-400

ISO 9001:2015

Designed, manufactured and/or distributed under this quality management system

* Footnotes

Wind Rating

BWS—Base Wind Speed; FBC—Florida Building Code