

PM-238T-48

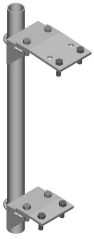

Adjustable Tapered Pipe Mount, 2-3/8 in OD x 48 in

Product Classification

Product Type Pipe mount

General Specifications

Mounting Saddle mounts

Note One 96 in x 8 in panel antenna per pipe mount

Pipe, quantity 1

Tower Taper Tapered

Dimensions

Height 1,219.2 mm | 48 in

Width 152.4 mm | 6 in

Length 152.4 mm | 6 in

Pipe Length 1,219.2 mm | 48 in

Pipe Outer Diameter 60.96 mm | 2.4 in

PM-238T-48

Outline Drawing

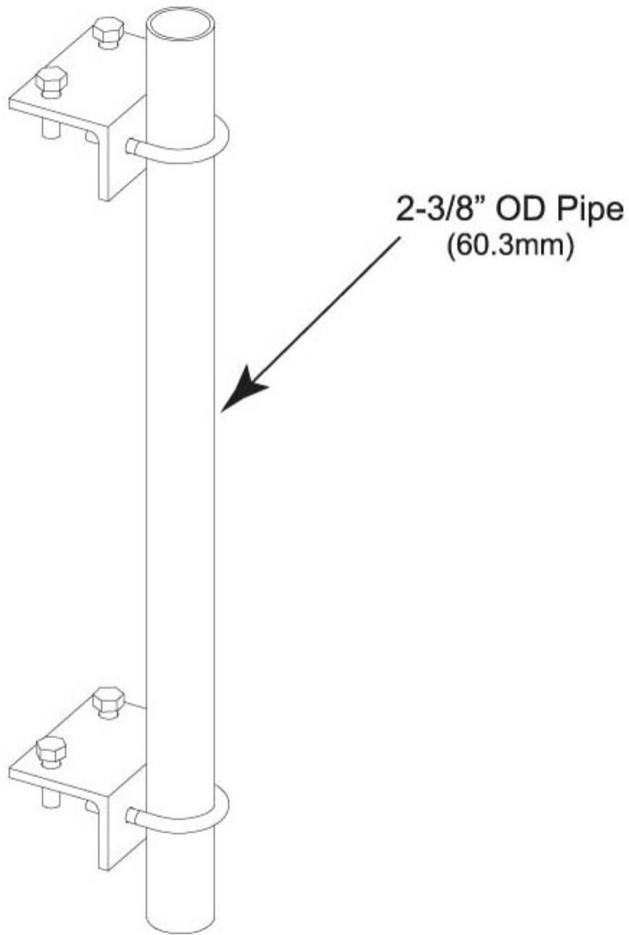

Material Specifications

Material Type Hot dip galvanized steel

Mechanical Specifications

Wind Rating 120 mph (BWS) at 150 ft AGL

Wind Rating Test Method TIA/EIA-222

Packaging and Weights

Included Brackets | Hardware | Pipe

Packaging quantity 1

PM-238T-48

Weight, net 6.4 kg | 14.11 lb

Regulatory Compliance/Certifications

Agency	Classification
ISO 9001:2015	Designed, manufactured and/or distributed under this quality management system

Included Products

- MT-650 – Plain End Pipe, 2-3/8 in OD x 48 in .120" A500C 46Ksi
- PM-TK – Pipe Mount Taper Kit

* Footnotes

Wind Rating BWS—Base Wind Speed; FBC—Florida Building Code