

COMMSCOPE®



Welcome to the CommScope-connected campus

Fiber. Copper. Wireless.
All these solutions, all from one partner.

Campus-scale networks call for world-class solutions from CommScope

Campus-scale communication networks present unique challenges that often don't have a simple, one-size-fits-all technology solution. So many factors go into your decision-making process—speed, capacity, flexibility, scalability and, of course, cost—that it takes a complete toolbox of solutions to ensure your next move is the right one.

WHAT DOES THAT TOOLBOX CONTAIN? WELL, PRETTY MUCH *EVERYTHING*, LIKE:

- Flexible fiber, copper and wireless infrastructure, built to work seamlessly together
- Intelligent, automated management that provides efficiency and security from end to end
- Design and manufacturing quality forged from decades of innovation and leadership
- The experience, skill and quality to provide total campus network solutions of any scale

You'll find that perfect toolbox with CommScope and our comprehensive portfolios of network solutions spanning every way you can connect a campus with confidence. CommScope is trusted all over the world for our ability to deliver solutions for even the largest university, hospital and corporate campus projects.

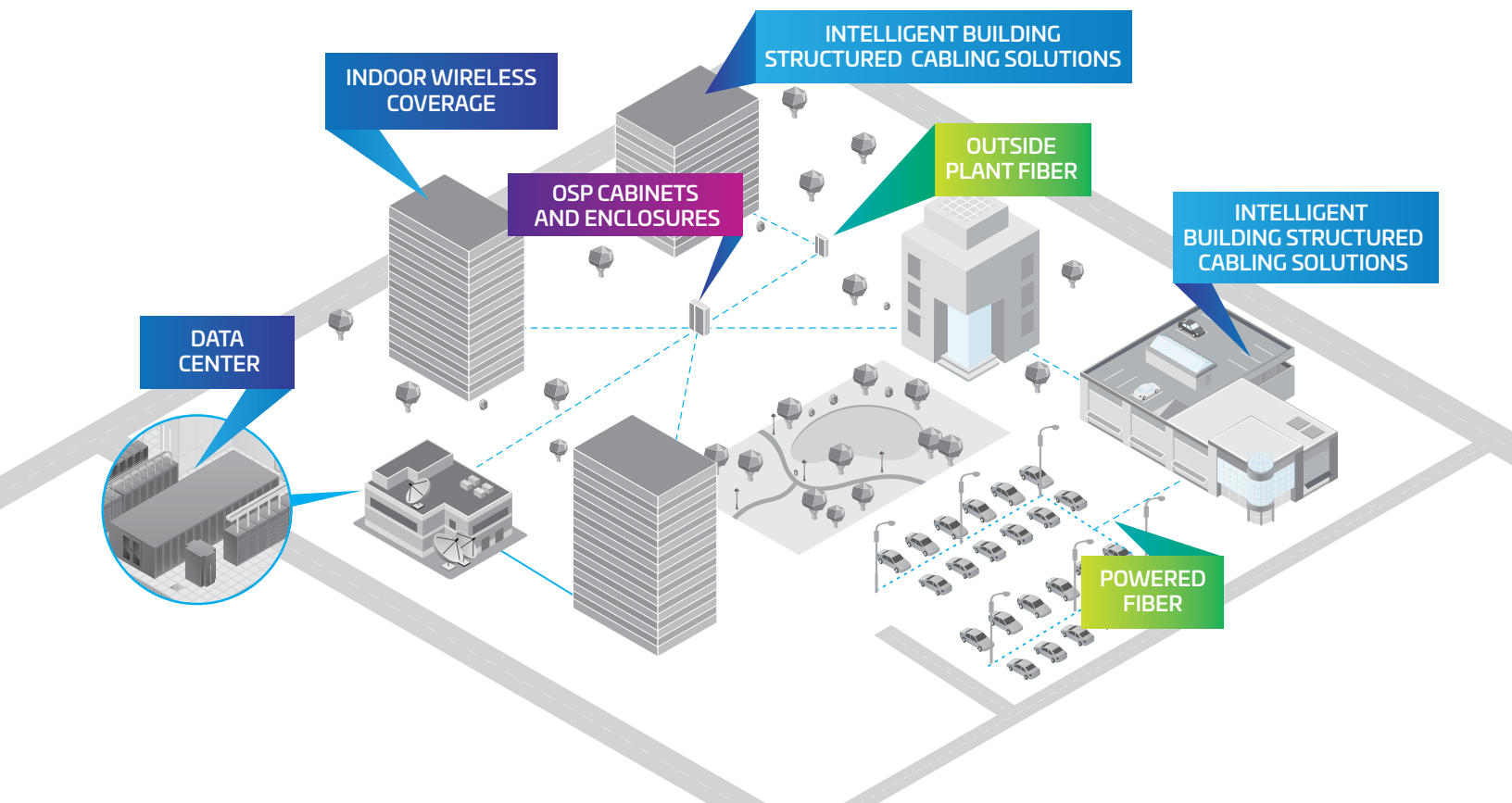

Fiber cable solutions



CommScope offers a full range of outdoor, indoor/outdoor, and indoor fiber cable designs to flexibly meet the unique challenges of connecting a multi-building campus environment. Supported multimode fiber types include OM1, LazrSPEED® OM3, OM4 and OM5 along with TeraSPEED® zero-water peak and bend-insensitive singlemode fiber types.

Total installation freedom allows for direct burial in trenches, underground and pre-installed in conduit; lashing to aerial utility poles and with options for self-supporting features as shown below.

CASE STUDY: A COMPLETE UNIVERSITY CAMPUS SOLUTION

A vast new university in the Middle East needed a complete, ground-up campus connectivity solution. New construction spread over two million square meters called for CommScope's best copper and fiber infrastructure, including 40 million feet of GigaSPEED X10D Category 6A cabling, 400,000 total feet of LazrSPEED® and TeraSPEED® interlocking armored fiber cable, and rack infrastructure for two complete data centers.

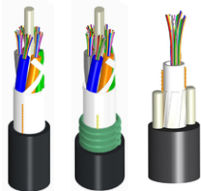
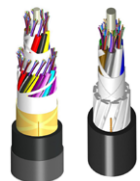
The network now supports the university's data, voice, IP cameras, wireless access and other connected services for more than 11,000 students and faculty.

Environment	Construction	Installation environment	Offering/compliance
Outdoor 	Central tube, loose tube, ribbon, all-dielectric rodent resistant, metallic	Aerial, direct buried, duct, micro-duct, drop	<ul style="list-style-type: none"> Compliant with relevant ANSI/ICEA, ISO/IEC and Telcordia specs
Indoor/outdoor 	Central tube, loose tube, ribbon, all-dielectric rodent resistant, metallic	Aerial, direct buried, duct, drop	<ul style="list-style-type: none"> OFNR, OFNP, LSZH, OFCR, OFCP Extensive CPR offer for EU countries Compliant with relevant ANSI/ICEA, ISO/IEC and Telcordia specs
Indoor 	Loose tube, tight buffered, interlocking armor, ribbon	Indoor plenum, riser, and low-smoke/zero halogen	<ul style="list-style-type: none"> OFNR, OFNP, LSZH, OFCR, OFCP Extensive CPR offer for EU countries Compliant with relevant ANSI/ICEA, ISO/IEC and Telcordia specs

Fiber panels



CommScope's fiber panel offering supports applications from building entrance and transition from outside plant (OSP) to inside plant (ISP) cabling, with solutions for the main distribution frame (MDF) and intermediate distribution frame (IDF). Wall-mounted and rack-mounted options are available. These include:

<p>SD fiber panels</p>  A black, rack-mounted fiber panel with multiple ports on the front face. The CommScope logo is visible on the front.	<ul style="list-style-type: none">• Available in 1U, 2U and 4U• Flexible architecture accepts preterminated, fusion splice and field-terminated cable options• LC, SC and MPO connector options• Splice modules include fiber pigtailed• LGX footprint supports a wide range of panels and modules
<p>HD fiber panels</p>  A black, rack-mounted fiber panel with a split tray design. It features a high density of ports on the front face.	<ul style="list-style-type: none">• Available in 1U, 2U and 4U• Higher density design supports up to 48 duplex LCs per RU• Flexible architecture accepts preterminated, fusion splice and field-terminated cable options• Automated infrastructure management (AIM) intelligence available with imVision®• Split tray design simplifies moves, adds and changes while minimizing disruption
<p>WBE-EMT</p>  A black, wall-mounted fiber panel with a split tray design. It features a high density of ports on the front face.	<ul style="list-style-type: none">• Wall-mount option provides transition to indoor cabling• Options to support 360G2-style or 1000-style modules or adapters• Three models available in 2-4-8 adapter panels• Cable mounting with cable glands• Cable clamp compatible (not included)• Security options



Fiber connectivity

CommScope's fiber connectivity solutions give you the flexibility and confidence you need to execute the best possible campus connectivity strategy.

Fiber modules, cassettes and adapter packs

<p>360G2 modules and adapters</p> 	<ul style="list-style-type: none"> • Compatible with HD and UD panels and WBE-EMT wall mount • Four modules or panels per RU • LC/MPO preterminated modules—12 LC duplex per module • LC, SC and MPO adapter panels • Available with imVision intelligence
<p>1000 (LGX) modules and adapters</p> 	<ul style="list-style-type: none"> • Compatible with SD panels and WBE-EMT wall-mount • Three modules or panels per rack unit • LC/MPO and SC/MPO modules • LC, SC and MPO adapter panels • Keyed LC options for secure networks

Fiber cable assemblies and fiber termination options

<p>Preterminated fiber cables</p> 	<ul style="list-style-type: none"> • OM3, OM4 and OM5 multimode and singlemode options • 12 fiber up to 864 fiber • LSZH, Riser and plenum • Interlocking armor option
<p>Jumpers and Pigtails</p> 	<ul style="list-style-type: none"> • OM1, OM3, OM4 and OM5 multimode options (LC and SC) • OS1a singlemode: UPC and APC, LC and SC
<p>Qwik II Mechanical Crimp for field termination</p> 	<ul style="list-style-type: none"> • QWIK-II no-epoxy, no-polish connectors feature a mechanical crimp • Fiber terminations easier and faster than typical epoxy terminations

For ordering copper and fiber products, please visit our [product catalog](#).

Powered fiber cable solutions

For extending Power over Ethernet (PoE) and PoE Plus applications beyond the industry-standard length limit of 100 meters, CommScope has developed the Powered Fiber Cable System (PFCS).

Using hybrid cable and a centralized power supply, PFCS simplifies the addition of small cells, Wi-Fi access points and IP cameras by distributing power and fiber within the same cable. This allows campus IT managers to locate remote devices anywhere they can run fiber cable—up to 3 km for standard PoE applications.

What's more, by providing the necessary dc power alongside optical fiber signals, PFCS allows networks to deliver low-voltage power from a centralized source without installing extra conduits, transformers or remote uninterruptible power supplies (UPS), as shown below.

CASE STUDY: POWERING AN EXTENDED OUTDOOR NETWORK

Nearly 30,000 people now count on reliable outdoor Wi-Fi access across the 580-acre campus of a top university located in the southeastern United States, thanks to CommScope's range-extending Powered Fiber Cable Solution (PFCS) and Power over Ethernet (PoE) extenders.

A live trial of the technology showed it could deliver data and power to distant outdoor Wi-Fi access points safely and effectively, without unsightly boxes or extra cables that could spoil the campus atmosphere.

Rugged enough to deal with the Southeast's fickle weather, the solution was rolled out campus-wide for a virtually invisible—but universally noticeable—boost to on-campus connectivity.

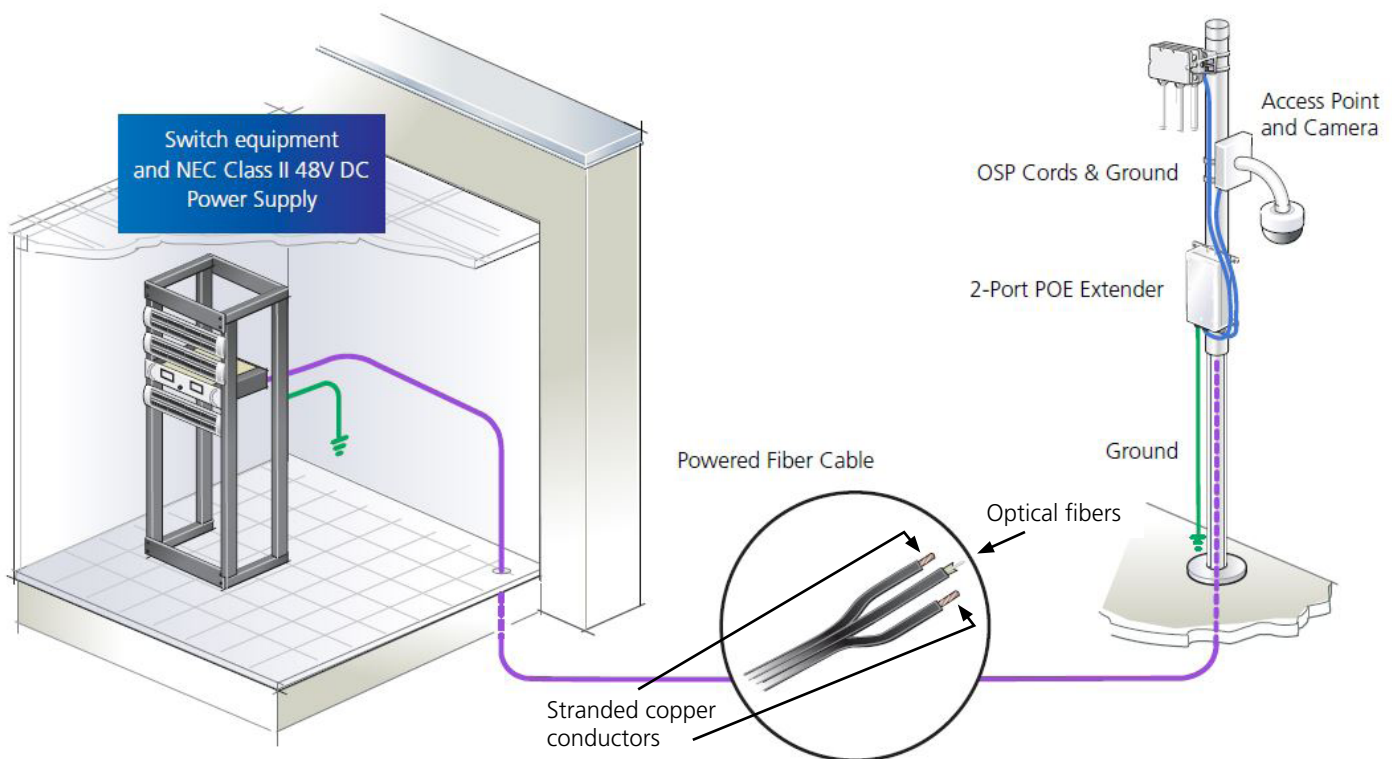

Outside plant fiber connectivity

Interconnecting campus buildings with fiber optics is typically supported by outside plant fiber cables routed directly between buildings. There may be instances where splicing is required, for applications such as the need to branch off fibers from one fiber cable to one or more additional buildings.

This can be accomplished with fiber splice closures, which provide the proper environmental protection for incoming cables as well as optical fiber splices. For campus networks that require OSP splicing but don't expect to have significant changes in connectivity between buildings, splice closures provide a low cost solution.

It can also be achieved through the use of an outside plant cabinet, which also adds the ability to easily make changes and reconfigure circuits via connectorised cables and fiber patch cords. For campus applications that are expected to have significant changes and reconfigurations between buildings, OSP cabinets offer flexibility and ease of operations from a centralized point.

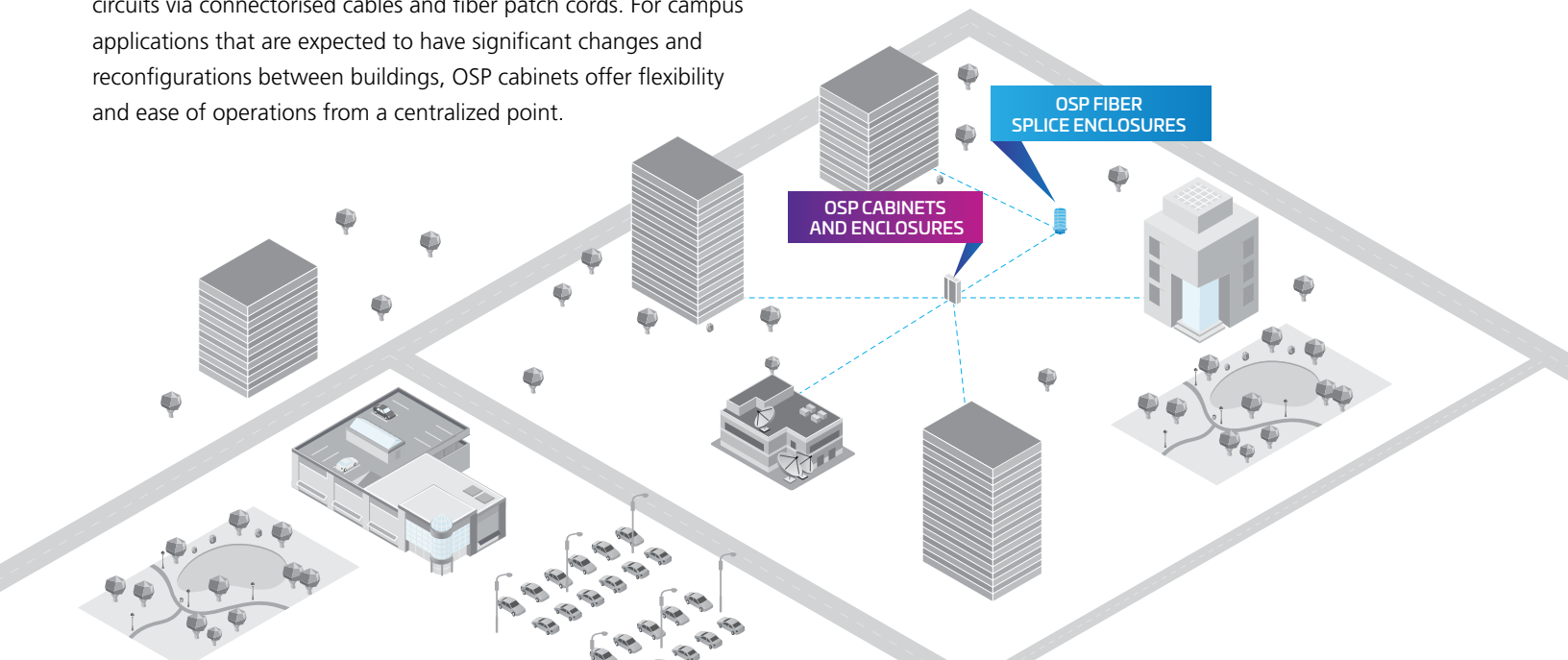

Fiber Splice Closures

CommScope offers an extensive line of fiber closures for campus applications. As the leading global supplier to the wireline market, CommScope has been a leader in buried and aerial solutions for more than 30 years. Each is designed to minimize installation time and cost, while ensuring optimal performance even in harsh environments.



Fiber OSP Cabinets

For campus applications requiring outside plant (OSP) fiber cabinets, such as the need to easily access and provide changes to OSP connectivity, CommScope provides an extensive offer in a variety of shapes and sizes. Our broad portfolio of field-proven solutions offers industry-leading port density, compact design, and rugged durability for the most extreme environmental conditions.

Copper solutions

Copper network infrastructure remains an economical way to ensure high-performance, scalable bandwidth, particularly in horizontal deployments. Many solutions providers specialize in copper or fiber; but, for campus-scale deployments, it pays to have access to a partner like CommScope that excels in both technologies.

In addition to providing industry-leading structured cabling systems for the enterprise local area network (LAN), CommScope also offers outdoor copper cabling solutions designed to extend copper-based connectivity in outside plant (OSP) environments. Within the 100-meter length limit set by the Ethernet copper LAN standards, CommScope's robust copper OSP solutions offer flexible performance and exceptional economy. A typical OSP example appears below.

Of course, if 100 meters isn't enough for an application, CommScope stands ready with the Powered Fiber Cable Solution (PFC) that can interface with your copper inside plant (ISP) infrastructure and connect buildings and devices—even if they are miles apart.

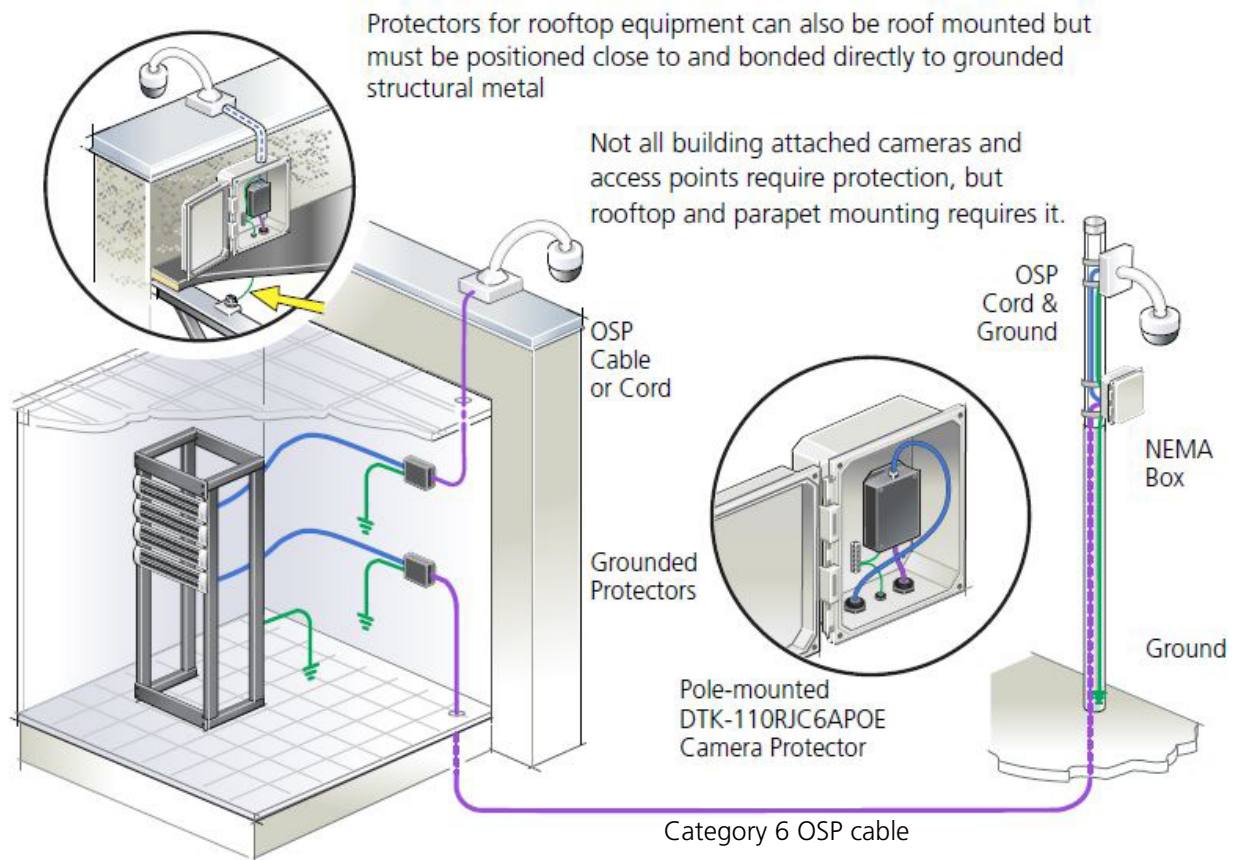

Indoor copper solutions

CommScope continues to lead the industry in indoor structured copper cabling with the signature SYSTIMAX® GigaSPEED X10D (Category 6A) and GigaSPEED XL® (Category 6) cabling solutions—powerful, flexible and designed to grow with your network’s needs for bandwidth and speed.

CASE STUDY:

ENTERPRISE LAN/WIRELESS POWER A CORPORATE CAMPUS

A world-class technology firm in San Jose, CA, needed to connect its new data center and corporate campus. They turned to CommScope solutions for its high-performance campus backbone needs as well as in-building wireless (IBW) solutions.

A complete slate of copper, fiber and wireless infrastructure solutions came into play, including high-performance GigaSPEED X10D® copper cabling, LazrSPEED 550 fiber and CommScope distributed antenna system (DAS) solution for ubiquitous indoor cellular service.

With these solutions, CommScope helped the customer achieve the truly unified network architecture that was central to their long-term strategy.

GigaSPEED X10D

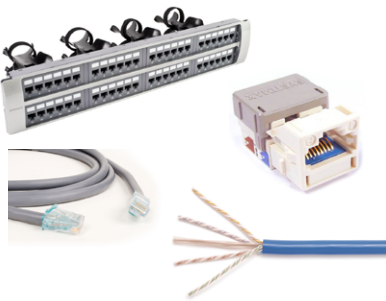

- Industry-low diameter of “true” Category 6A unshielded twisted pair (UTP) cable = .285 inches
- SYSTIMAX Optimized Material Technology (OMT) platform optimizes transmission performance
- Round design—one of the few Category 6A UTP cables packaged in a box
- Available as CMR, LSZH and plenum; U/UTP, F/UTP and S/FTP
- Intelligent and intelligent-ready imVision support for physical layer traceability
- Simpler installations with field-terminated and preterminated options

GigaSPEED XL



- Significant performance margin over Category 6 channel standards
- Design flexibility
- Intelligent and intelligent-ready imVision® support for physical layer traceability
- Simpler installations with field-terminated and preterminated options

Automated infrastructure management (AIM)

Deploying a campus-sized enterprise LAN is only the first step. After that, the main challenge is managing it efficiently and securely—and, for this challenge, CommScope offers a powerful and intuitive automated infrastructure management solution called imVision.

imVision provides the ability to manage and administer outside plant (OSP) connectivity between buildings—tracking and documenting device adds and changes automatically, identifying potential problems or security breaches, and issuing automated service tickets for faster incident resolutions. imVision offers a single platform to manage desktop, inter-building and data center connectivity for all campus network applications.

In short, imVision is like GPS for navigating your campus-scale network and every connection in it—all in real time.



CASE STUDY:

IMVISION® PROVIDES END-TO-END NETWORK INSIGHT AND SECURITY

A large financial institution headquartered in Spain needed to connect its campus network with CommScope’s high-performance copper and fiber infrastructure solutions. The customer also deployed the imVision automated infrastructure management (AIM) solution to secure and manage 35,000 copper ports and 5,000 fiber ports across their new network.

With imVision, the customer had total, real-time visibility into the location and credentials of every single network-connected device—right down to its port location.

This not only helped them run a more efficient network, but also made it easy to spot any potential intrusion attempts.

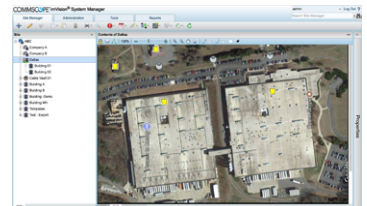
<p>imVision Controller</p> 	<ul style="list-style-type: none"> • imVision controller provides circuit trace information and complete connectivity map for selected circuit—and assists technicians with guided patching
<p>Intelligent Panels</p> 	<ul style="list-style-type: none"> • Copper and fiber panels upgradeable in service • Utilizes standard patch cords
<p>System Manager Software</p> 	<ul style="list-style-type: none"> • System manager software provides full connectivity map of buildings, floors and rooms • OSP feature also shows connectivity between buildings • Single platform to manage buildings, data centers and OSP connections • PoE features provide additional insight and management of PoE applications and powered devices



In-building wireless (IBW)

Four out of every five mobile connections are made indoors. The problem is that the wireless networks supporting those connections are crippled at the door—cell signals can't reliably penetrate concrete and steel buildings or low-E glass, resulting in those "dead spots" where calls get dropped and service bars just vanish.

In enterprise environments where wireless voice connectivity is a must, this challenge can be solved with an in-building wireless (IBW) solution that supports traffic (like voice calls) that Wi-Fi doesn't typically handle. In-building wireless includes solutions like small cell and distributed antenna systems (DAS).

Not long ago, most In-building wireless solutions required a lot of expensive specialized RF infrastructure—but now, CommScope offers In-building wireless solutions that are easy to deploy, scale to cover as many buildings as required, and do it all on inexpensive IT cabling like Category 6A and fiber-optic cable. The ION[®]-E DAS and Era[™] C-RAN antenna systems are described below



<p style="text-align: center;">ION-E</p> 	<ul style="list-style-type: none"> • Single infrastructure supports multiple service providers and all technologies (2G, 3G, 4G/LTE) • Frequency-agnostic universal access point (UAP) • Easy setup and operation through automated hardware detection and browser-based configuration GUI • All-digital architecture reduces space, power and fiber transport costs • Uses Category 6A and fiber optic cabling
<p style="text-align: center;">Era</p> 	<ul style="list-style-type: none"> • Era offers all the features of ION-E, plus: • Takes remote signal source from the operator's facilities, reducing on-campus footprint • Higher power, outdoor-rated access points to serve larger venues and outdoor spaces • ION-E can be field-upgraded to Era • Uses Category 6A and fiber optic cabling

Microwave antennas

Some campus applications may not have right-of-way between buildings or may require a secondary connectivity path. For these applications, microwave links can provide the ideal solution.

CommScope is the largest supplier of microwave antennas in the world, with a portfolio that covers frequency bands from 3 to 80 GHz, and antenna diameters from 8 in (20 cm) up to 15 ft (4.5 m). CommScope also offers flex-twist and elliptical waveguide needed to connect the antennas to the radio.

To connect a pair of adjacent buildings—or to link to a remote facility—if there is a direct line of sight, then CommScope has a microwave antenna solution to do it.



Unlock the potential of every new day with CommScope

A growing network needs a wide range of specialized solutions to scale gracefully along with your business. There are always vendors out there who can provide a slate of copper infrastructure solutions. Others specialize in fiber. Still others offer automated infrastructure management (AIM) solutions or distributed antenna system (DAS) options. And very few are equipped to handle the largest-scale deployments, such as massive sport stadiums or mega-universities.

CommScope is different. We have the solutions and we have the scale to deliver. Only CommScope offers complete campus enterprise LAN and wireless solutions with a worldwide manufacturing footprint and our reputation for the strictest engineering and manufacturing standards in the business.

A campus-wide network needs more than one technology to create a seamless, integrated experience. But you need only one global partner to make it all happen—CommScope. Contact your [CommScope Sales Executive](#) today.

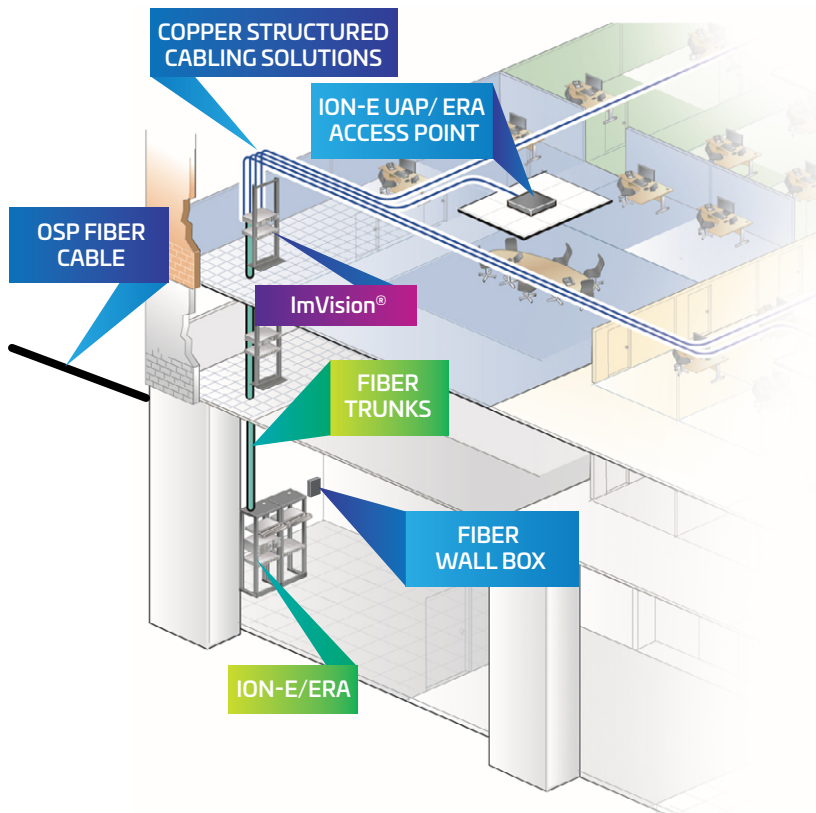

CommScope pushes the boundaries of communications technology with game-changing ideas and ground-breaking discoveries that spark profound human achievement. We collaborate with our customers and partners to design, create and build the world's most advanced networks. It is our passion and commitment to identify the next opportunity and realize a better tomorrow. Discover more at commscope.com

COMMSCOPE®

commscope.com

Visit our website or contact your local CommScope representative for more information.

© 2018 CommScope, Inc. All rights reserved.

Unless otherwise noted, all trademarks identified by ® or ™ are registered trademarks, respectively, of CommScope, Inc. This document is for planning purposes only and is not intended to modify or supplement any specifications or warranties relating to CommScope products or services. CommScope is committed to the highest standards of business integrity and environmental sustainability with a number of CommScope's facilities across the globe certified in accordance with international standards, including ISO 9001, TL 9000, and ISO 14001. Further information regarding CommScope's commitment can be found at www.commscope.com/About-Us/Corporate-Responsibility-and-Sustainability.

BR-112675-EN (05/18)