

Understanding the RF path

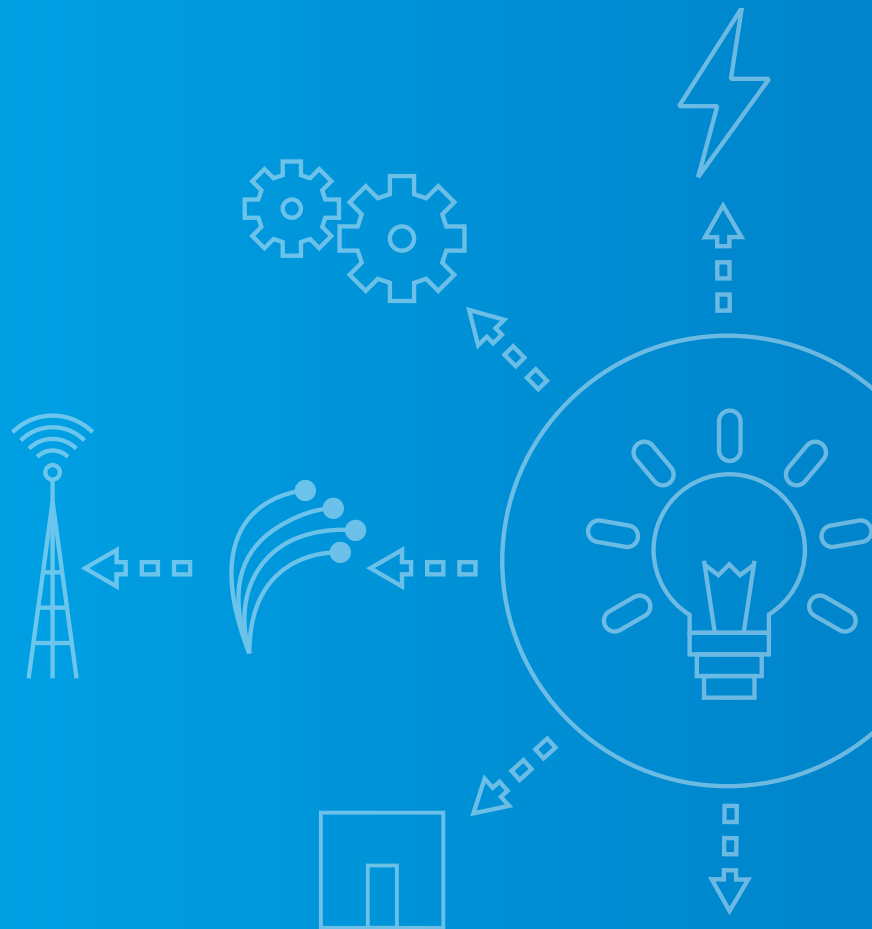

TABLE OF CONTENTS

- ▶ **Chapter 1** Introduction: Welcome to RF communications **3**
- ▶ **Chapter 2** The solutions, practices and trends: Cell site development **8**
- ▶ **Chapter 3** Getting the signal across: Base station antennas **19**
- ▶ **Chapter 4** Working within the limits: Co-siting solutions **44**
- ▶ **Chapter 5** Talking and listening at the same time: Transmission and receiving isolation systems **59**
- ▶ **Chapter 6** Getting from the air to the network: Cables and connectivity **76**
- ▶ **Chapter 7** Clearing the connections: Overcoming passive intermodulation (PIM) **97**
- ▶ **Chapter 8** Getting the most from every cycle: Spectrum management **105**
- ▶ **Chapter 9** The infrastructure behind the call: Backhaul **115**
- ▶ **Chapter 10** The next RF architecture evolution: C-RAN **137**
- ▶ **Chapter 11** The energy of communications: Powering wireless networks **147**
- ▶ **Chapter 12** Successfully planning against failure: Reliability in wireless systems **172**
- ▶ **Chapter 13** Extending the network indoors: DAS, C-RAN antenna systems, and small cell solutions **187**
- ▶ **Chapter 14** Finding safer ground: Lightning protection **196**

- ▶ **Biographies 210 | ▶ Appendix A 214 | ▶ Glossary 219**

Introduction:
Welcome to RF communications



Chapter 1

Introduction: Welcome to RF communications

For decades, CommScope has grown up alongside the science of communication with practical solutions. We have been dedicated to helping the world achieve more powerful, efficient and innovative ways to network information and people. We have partnered with leading networks all over the world to help them maximize opportunities and unlock hidden potential, because we believe in the power of innovative networks and those who build them.

To us, true partnership also includes sharing what we've learned along the way. The result is this book, which presents the fundamentals of radio frequency (RF) communications in a comprehensive, yet approachable, way.

Many different kinds of communication rely wholly or in part on RF technologies. The field is not limited to long-established applications like broadcast radio, shortwave and so forth—it also includes modern cellular communications such as 4G/LTE and emerging 5G

networks. It encompasses indoor wireless solutions that allow a mobile user to find a clear connection from anywhere in a vast building complex, aboard an aloft airliner or from a bullet train zipping through a tunnel under miles of granite. It even includes transmissions in the microwave bands, which, as you will learn, are an effective way to move vast amounts of data miles across a network without cable.

Indeed, as established a science as RF is, there remains incredible potential for new and innovative solutions that expand its reach and usefulness across every aspect of modern life. CommScope is dedicated to unlocking this potential.

The goal of this book is to explore the many dimensions of RF communications—past, present and future. It will also examine the technologies, solutions and practices that power the ongoing evolution of RF's role in the world, including many innovative technologies and practices that CommScope has brought to the industry. Some of this material is theoretical and technical, but every effort has been made to keep it as approachable as possible. Consider this *RF Fundamentals 101*.

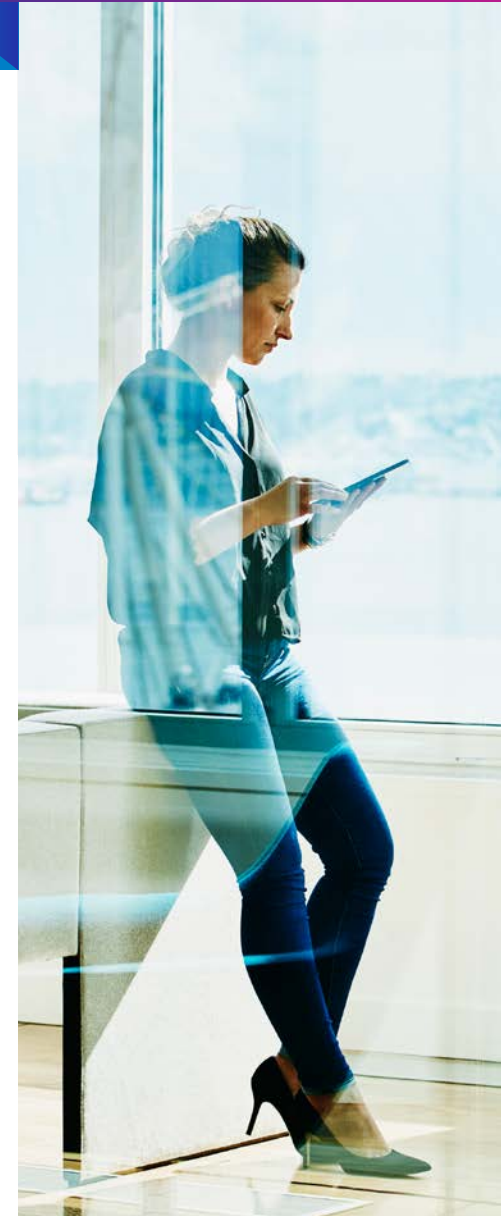

RF systems, then and now

Wireless communication is a mature science. RF systems have been in commercial use since the 1940s, with the earliest examples including community repeaters, paging systems, point-to-point links and specialized mobile radio (trunked) systems.

More recent innovations and uses of the RF spectrum include the cellular radio networks we are all now familiar with. These applications originated in the 1980s and have evolved into a diverse and dynamic ecosystem of technologies, standards and architectures. Alongside these applications, other wireless technologies have become mainstream, even common features of everyday life—Wi-Fi, for example.

The shared link

These diverse applications all share one important characteristic: they all utilize a limited range of radio frequencies to move information between radio base locations and remote users.

The chain of components required to make this movement of information possible is complex and diverse. CommScope's wide range of solutions allows us to present a fairly comprehensive view of these systems, explain how they function and

show how they interweave to create the fabric of modern communications. These systems include such components as:



Antennas, which are the structures where radio signals enter and exit the air



Coaxial copper cable, which features an inner and outer conductive layer for signals to travel



Fiber-optic cable, which uses pulses of light to transmit information efficiently



Filters, which prevent the intrusion of interfering signals from entering the RF path



Amplifiers, which increase signal transmission power to extend distance or improve signal quality



Enclosures, located at the base of a cell site, connected to remote radios and antennas at the top



Power backups, which ensure uninterrupted wireless service in the event of grid power failure

This is only a partial list, but this book will explore these and other components in the chapters ahead.

RF communications: The early years

While the full story of RF communications continues to be written by a dynamic, growing industry, the current capabilities of modern RF technologies would almost certainly exceed the wildest dreams of the field's earliest pioneers. We take our connected world for granted, but the earliest commercial uses were not nearly so ubiquitous.

The first RF systems featured a base radio using an omnidirectional antenna to communicate with one or more mobile users. Then, as now, the effective coverage radius of that base radio was limited by factors including RF power, antenna height, and the sensitivity of mobile receivers that were vulnerable to thermal noise and other interference sources. These systems were also limited by the fact that certain frequencies could only be used once in a particular geographical area. Once a mobile user left that area, no communication was possible.

The engineers of AT&T Bell Laboratories envisioned a future that would require much higher RF capacities to service thousands or millions of users at once. To deliver this future, they developed the cellular concept: a wireless network that uses lower antenna heights and transmission power levels to create limited-radius coverage areas that used and reused the same

frequencies within its coverage area. Voice and data calls could be seamlessly “handed off” to neighboring cells as the user moved from one coverage area—or cell—to the next. The close-proximity reuse of radio channels is the fundamental concept of cellular telephones, and even today, it remains the reason why wireless networks can move vast amounts of traffic within a comparatively narrow band of RF spectrum.

The business case for technical expertise

Wireless service providers monitor key performance indicators within their territories to identify coverage problems and assure customer satisfaction. These indicators include quality of service (QoS), dropped calls, failed access attempts, and other criteria. Their engineers are on the front lines of this battle for quality and constantly optimizing network performance as traffic grows at an incredible rate.

Of the many ways an RF engineer can optimize a network, the first and most essential is to ensure a solid physical foundation of interoperating components across the RF path (Figure 1.1).

42% DATA TRAFFIC GROWTH

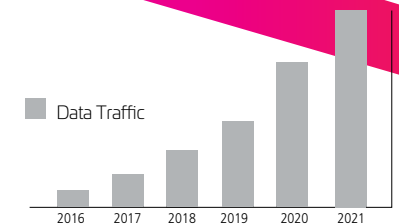

42% data traffic CAGR growth each year through 2021, worldwide

SOURCE: Ericsson Mobility Report, June 2017

1 | Introduction: Welcome to RF communications

Not only does this foundation provide the best scenario for efficient operation, it also helps minimize the likelihood of downtime, which is a disruptive and expensive proposition for the wireless service operator. For these reasons, it's vital for the RF engineer to understand the latest standards and specifications, and to choose components that meet or exceed those standards and specifications. It is an unfortunate fact in the wireless industry that not all solutions are built to meet the latest requirements—it is incumbent on the provider and the engineer to ensure compliant components are used in the RF path.

Understanding the RF path and the parts that make it operate efficiently is the journey this book will follow. CommScope is glad to have you join us for the trip. Let's visit the first stop along the way in the next chapter, where we will examine the makeup of a modern cell site.

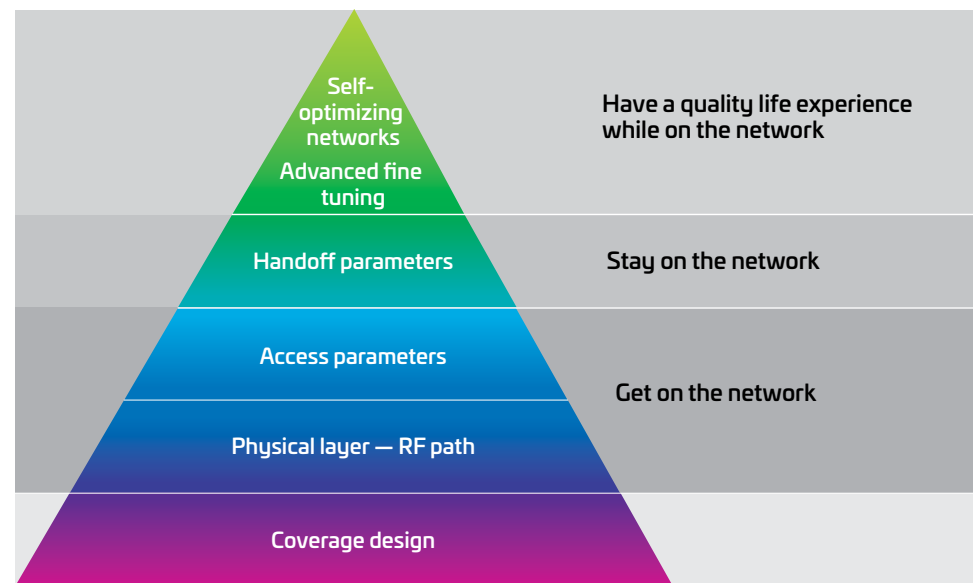

1.1: The interconnection of technology, design and optimization

The solutions, practices and trends: Cell site development



Chapter 2

Building a new cell site—or upgrading an existing site—raises some of the same questions as building a new house, such as deciding what materials to use, who to entrust with the construction, and how to get the best results for your money.

Building or retrofitting also forces a discussion about the latest technologies, practices and solutions. The components you use for a site today may be very different from those used for a site built a year ago—and best practices may have evolved as well. In this chapter, we'll look at some of these solutions and practices as they exist today, and try to discern the future emerging from current industry trends.

Chances are that, if you are developing a new cell site or upgrading an existing site, you will have plenty of third-party help in the process since site deployments involve so many different RF disciplines in their construction. The topics we'll cover here will span the appropriate scale of the deployment, your contractors' work, and the decisions you will have to make with them.

Macro or metro? Know the difference.

First and foremost, you need to know how the site will fit into your overall wireless strategy, and what scale is required to fulfill that role. The two primary choices available are macro cell sites and metro cell sites.

Macro sites are the large steel towers you're familiar with. They typically host a number of different antennas, wiring and radio equipment needed to receive and transmit cellular signals over a significant area. Metro cells, on the other hand, are smaller, more easily concealed sites that are designed to meet stringent appearance and size criteria demanded by many urban zoning regulations.

While metro cells are an important part of a forward-thinking wireless strategy, this book will mainly address the processes and components involved in deployments of macro cell sites. We will begin with the cabling infrastructure used in macro sites.

Choosing cable and connectors

Efficient cell site operation relies on the precise pairing of components. As we will discuss in detail in Chapter 3, certain cable types are designed to work with certain antennas. As we will explore in Chapter 7, those cables

Macro cell sites

Large, conventional, standalone cell sites that occupy a dedicated space.

Metro cell sites

Smaller, lower-power cell sites that can be concealed in lamp posts or other fixtures to add network capacity with fewer zoning and aesthetic challenges.

must interface with their systems via connectors built for certain frequencies and power levels.

These may be copper coaxial cables (Figure 2.1) or combined fiber-optic and power cables, known as hybrid cables (Figure 2.2). With more and more sites

moving to fiber-optic infrastructure between radios and base station, chances are that new installations will use hybrid rather than coaxial cable. We will explore modern connectivity solutions later on in Chapter 7.



2.1: The interconnection of technology, design and optimization

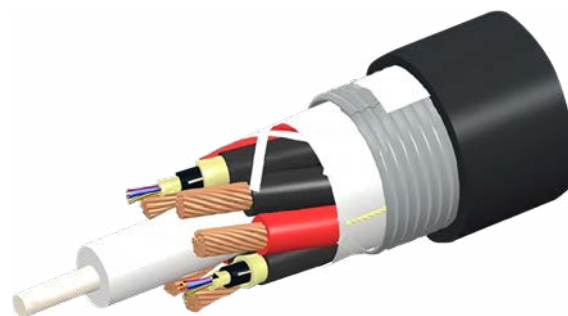

2.2: Example of hybrid cable containing fiber-optic and copper power cables

Coaxial cable

A type of cable featuring an inner conductive core, an outer conductive layer, and a dielectric, or insulating, space between them. Coaxial cable connects antennas to radios and/or base stations.

Hybrid cable

A cable combining both fiber-optic connectivity and a copper power cable. Hybrid cables remotely power tower-mounted radios and connect them to base stations located on the ground.

Both coaxial and hybrid cable must be handled with care during installation in order to avoid damaging their internal structure and seriously compromising their performance in the RF path. Here are several best practices for installations:

- **Use the right tool for the job.** Using the appropriate cable prep tool—usually available from the cable's manufacturer—is the only way to cut and prep cable ends for use in connections. Never use a saw; they leave metal filings behind, which cause poor electrical performance and problems with passive intermodulation (PIM).
- **Watch those tricky curves.** Different cable types have different degrees of allowable bend radii, or flexibility, so you must observe the manufacturer's prescribed bend radius for your particular cable. Bending too tightly can lead to poor electrical performance in coaxial cable; overbending the glass in a fiber-optic cable causes stress cracks to appear that also cripple performance.
- **Keep your cables consistent.** If at all possible, use RF jumper cables, either coaxial or hybrid, from the same manufacturer to make those tight connections. Doing so provides consistent RF performance and guarantees PIM performance.

- **Ensure proper cable support.** Manufacturers publish specifications describing how to support lengths of cable, both vertically and horizontally. Your specific guidelines will depend on your cable's construction, size and weight. If possible, use support clamps from the same manufacturer to avoid damage to the cable and loss of performance. Using third-party clamps may also invalidate your warranty.
- **Lift smart.** Getting cables up an antenna tower is difficult. Fortunately, using the correct hoisting grip will let you put that cable where it needs to be without damaging it. Hoisting grips come in several types and sizes, so make sure yours matches your cable's specifications.

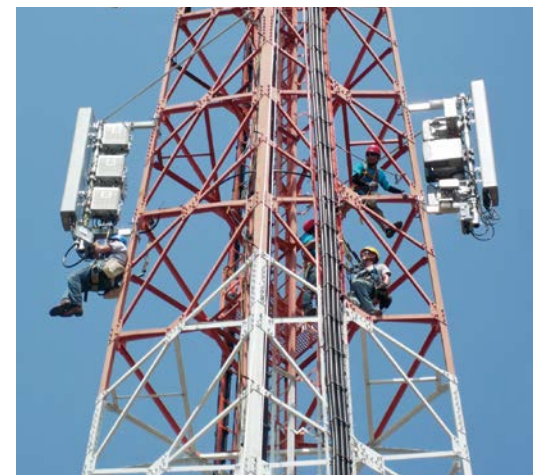

- **Go to ground.** Grounding the cable is very important to prevent damage from lightning strikes. Best practices dictate at least three grounding points: at the top of the tower, at the bottom of the tower and just outside the entrance to the outbuilding, shelter or cabinet.
- **Finish with the seal of approval.** Connectors are particularly vulnerable to infiltration by weather and moisture. As soon as the connections are made, you should weatherproof them. Butyl tape is the preferred method; but, in tight connection spaces, like those atop the antenna tower, you can opt for heat-shrink tubing applied with a heat gun.

By following these recommendations, you can help ensure the cabling used in your cell site will operate at peak efficiency with minimal maintenance.

Mounts matter

More and more of the components of the RF path are being mounted on towers, such as remote radios and amplifiers, as well as additional antennas to support newly-available spectrum. Using the correct mounting hardware for these components and antennas is vital to ensure proper support and trouble-free operation. Overloaded tower tops with insufficient mounting solutions can shorten the operational life of equipment and introduce the possibility of performance-sapping

passive intermodulation (PIM), which we explore in detail in Chapter 7.

This is particularly true for microwave backhaul antennas, which are larger, parabolic antennas that are designed to move aggregated site traffic up and down the operator's network by means of a highly-directional beam. In this way, microwave backhaul antennas can quickly move vast amounts of data via distinct links, or "hops," as long as the two antennas are in direct line of sight with each other. Proper mounts are essential, since these antennas can be very heavy and catch a great deal of wind. Even a .10-inch deflection from its intended link path can have a serious impact on throughput; over a link of several miles, that .10-inch deflection can translate into many feet—and a missed receiver.

A six-foot diameter microwave antenna's mounts must be rated to withstand 1,400 pounds of lateral force to ensure it remains on target, even in high winds. You can learn more about the functioning of microwave backhaul systems in Chapter 9.

Using remote electrical tilt antennas

Of the many ways to improve performance from a cell site's antennas, a particularly effective method is beamtilt. It involves physically tilting the orientation of the antennas below the horizon, placing its greatest gain—its operational power—where it's needed most (Chapter 3).

Electrical tilt antenna

An antenna fitted with actuators that can adjust its tilt relative to the ground. Changing tilt affects gain, or performance, of the antenna within defined geographical areas.

2 | The solutions, practices and trends: Cell site development

This involves physically moving the antenna to change its orientation. This is accomplished with electrical tilting mechanisms, or actuators, which can be operated from a remote location (Figures 2.3, 2.4, and 2.5).

These mechanisms are controlled by an Antenna Interface Standards Group (AISG) remote electrical tilt (RET) controller, which connects via AISG cables at the cell site for adjustment (Figure 2.5).

As precision equipment, these tilting antennas can be a challenge to install and adjust properly. Getting the best result is a matter of understanding the software just as much as the hardware, but there are several ways to avoid common pitfalls:

- **Install the software first.** Before your crew goes to the cell site, install the manufacturer's software and become familiar with the controller's operation. This early training will help your team members hit the ground running when they arrive.
- **Check for program updates.** Just like your laptop or cell phone, driver software for your electronic tilt actuator system is constantly being updated. These updates improve operation and expand compatibility to include more types of antennas. Make sure your software is current by checking for updates on the manufacturer's website.



2.3: An electrical tilt mechanism, or actuator, for a cell site antenna



2.4: A base station antenna (BSA) with integrated RET actuators



2.5: An example of an AISG RET controller module

- **Understand the naming conventions.** To prevent onsite confusion, use conventions for the configuration of actuators that everyone will understand.
- **Test before installing.** For new installations, a little upfront effort can prevent big headaches later. Test the actuators, cables and other components before installing them on the tower. It's much easier to address problems when the components, and you, are on the ground.
- **Match antennas and tilts.** Not every antenna has the same tilt range, so be sure you select the correct one from the database before adjusting it. Each antenna's address is based on its product serial number, so be sure to keep a written record. You should double-check your tilts through tab reports generated by the controller.
- **Keep a spare cable on hand.** Bring a spare cable to the site in case you need to troubleshoot a non-reporting actuator. It's the fastest, surest way to tell if the problem is a faulty actuator or just a bad cable.
- **Check before tilting.** Before making any new tilt adjustments, pre-scan the other antennas to determine their tilt values.
- **Double-check your work.** After making the adjustment, you should perform a post-scan to confirm the new settings have been correctly applied.
- **Don't tape cables and connectors.** Using electrical tape won't keep moisture out—in fact, it gives water a place to accumulate in the connector, where it can cause shorts.
- **Protect against lightning.** Lightning protection units should be installed at the base of the tower, or just before the cable enters the shelter or cabinet. Also, as stated above, it should be grounded in at least three locations: at the top of the tower, at the bottom of the tower, and just before entering the enclosure or platform.
- **Don't splice in a ground lead.** Cutting into the jacket to attach a ground to the thin foil tape inside will cause water migration, damaging the conductors below the foil.
- **Go right to the source for cable.** It's considered good practice to purchase your cable directly from the manufacturer rather than obtaining it through a third party. Each manufacturer's system requires specific electrical conductors, and using a mismatched cable may lead to actuator failure, voiding your warranty.
- **Make the right connections.** The home run cable's male connector—the end with the pins—is the end that connects to the controller. Also, be careful not to cross-thread actuator cables at the controller or on the actuator itself. They should be hand tightened only. Never use a wrench.

- **Cycle the actuators when you're done.** After addressing each actuator, cycle it fully to confirm there are no hidden problems.
- **Check for cable stress.** All cables should be free of stress and secured in intervals of 18 to 24 inches, or per manufacturer's standards. Keep in mind that coaxial and hybrid cable have different handling and hanging instructions.

Thorough planning and clear procedures like these will ensure your cell site reaches and maintains its maximum potential while also allowing you to make the proper adjustments as your network evolves.

The bottom of the tower is evolving as well

New connectivity options aren't the only recent advances in cell site design. The base station and associated equipment at the bottom of the tower are also trending toward more energy-efficient designs and strategies.

Traditional enclosures—the small buildings you see at the base of some cell towers—are becoming a thing of the past. These structures can range in size from a medium-sized shed to a modest-sized home, depending on the amount of equipment they support (Figure 2.6).

Cabling from the tower terminates into the base station equipment here; they may also contain electrical transformers, large battery power backup arrays, racks of switches and servers, connectivity to the core network,



2.6: A traditional cell site enclosure housing radio and base station components

and, of course, all the climate control equipment needed to keep the equipment operating within its specified temperatures. Unsurprisingly, this much high-power equipment in a confined space generates a great deal of heat that must be constantly removed from the enclosure.

As cell sites become more powerful and numerous, it has become clear this traditional way of storing and operating the base station equipment is relatively inefficient, its energy demand is unsustainably steep and its complexity slows new site installations just as operators are rolling out more new deployments than ever.

Platforms and cabinets

One of the most intuitive ways to remove enclosures from the equation is... to simply remove the enclosures. Platform-built base stations are a rapidly growing trend in the wireless industry for a number of reasons relating to cost, deployment speed and energy efficiency (Figure 2.7).

Platforms are attractive options because the ongoing trend in integrated electronics has reduced the overall footprint of a site's equipment complement, but increased their heat output. Platforms allow air cooling to manage heat removal, greatly reducing energy use and lowering costs.

A platform solution typically features integrated electrical grounding, fiber and copper connectivity support, and enough room for the base station equipment—plus a little extra for a technician to service the components located in the cabinets on the platform. It's surprising how much performance can be loaded onto such a platform, which is, in all ways, a miniaturized cell site base station without the building—and without the extra costs and weeks of construction time a traditional enclosure requires.

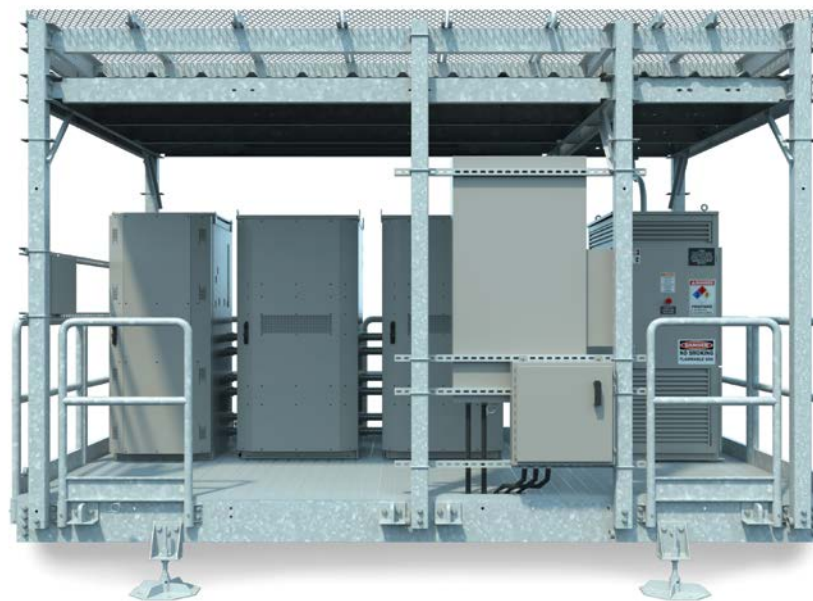

2.7: An example of a CommScope Integrated Platform Solution that replaces a traditional cell site enclosure

A CommScope Integrated Platform Solution (IPS) like the one pictured in Figure 2.7 includes:

- Fiber cable and cable entry kits
- Grounding lugs and bars
- Battery backup cabinets
- BBU, RF and fiber equipment cabinets
- Canopies and ice shields
- H-frames for mounting ancillary enclosures
- Integrated AC load centers and generators
- Railings, platform and footing supports
- Seismic bracing

Another big advantage to wireless operators is that they can order IPS units with any specific configuration of CommScope solutions pre-installed, pre-configured and factory tested. It then arrives at the work site, fully assembled, and can be installed and operating in as little as four hours. This helps operators schedule site construction more flexibly, makes turn-up processes more consistent and significantly reduces labor expenses. Other manufacturers also produce platform base stations, but, as of this writing, only CommScope's IPS alternative can be so extensively customized in advance.

Free-air cooling enclosures

Free-air cooling is another fast-growing practice found at the bottom of the tower. It's a compelling advantage for new cell sites too complex for a platform base station (or where it may not be practical due to environment), as well as for existing sites where equipment is already integrated into a traditional enclosure.

As stated above, air conditioning costs are among the most important drawbacks to traditional enclosures.



2.8: The inlet and filtration system on CommScope's Monitor free-air cooling solution

As more and more industries gain insights into their electrical costs—in environmental as well as financial terms—there’s a great deal of impetus to reduce the impact of air conditioning on the balance sheet, and on the CO₂ footprint.

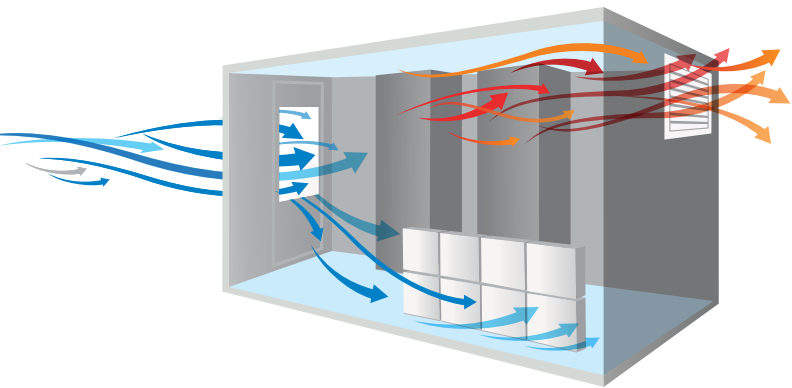

Free-air cooling uses advanced backward-curved radial fans to force outside air through the enclosure. The air is directed downward, forcing the warmer interior air up and out exhaust vents on the opposite side of the room. In order to prevent airborne contaminants from affecting the sensitive electronics inside, free-air solutions incorporate sophisticated filtration systems. CommScope’s Monitor solution is an example of such a system; it reduces the internal temperature by 10 degrees Celsius without the use of any air conditioning at all (Figure 2.8).

Free-air cooling is both used in new sites and retrofitted for existing sites, resulting in greatly reduced electrical draw and lower environmental impact—two worthy goals any good corporate citizen would be eager to achieve.

Developing a new site means new solutions and practices

Networks are growing quickly all over the world, and new sites are popping up like spring dandelions. The technology and expertise behind these new deployments are also growing and evolving, introducing efficient new ways to provide coverage and capacity in every corner of the network.

Developing a new site—or upgrading an existing site—requires a unique skill set and a firm grasp on the latest best practices. Coaxial cable is giving way to hybrid solutions; more components are going onto the tower; fiber speed is connecting radios, base stations and backhaul; and enclosures give way to more efficient platforms.

A lot has changed recently, and the pace of evolution is only going to increase. This makes a reliable, end-to-end solutions partner an even more valuable asset for your growing network.

Chapter 2 summary

Cell site development

- Technologies are evolving fast
- Coaxial and hybrid cable solutions have distinct handling requirements and installation practices
- Fiber-based solutions are becoming the norm
- Remote electrical tilt can improve site performance
- Traditional enclosures are being replaced with more compact and efficient platform solutions
- Free-air cooling helps improve the energy efficiency of sites where enclosures are still required
- Consistency in manufacturer can help simplify site deployments

Getting the signal across: Base station antennas

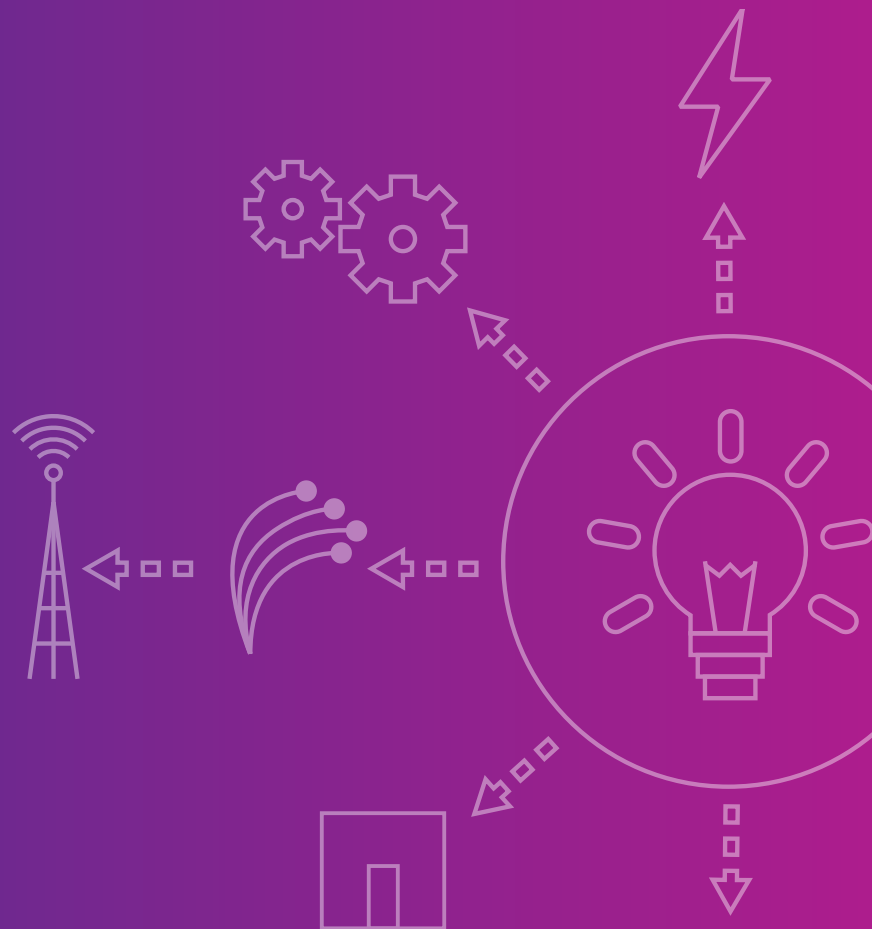

Chapter 3

Getting the signal across: Base station antennas

Chapter 3

Today, the quest for stronger signals—or, in some places, any signal at all—has become a routine part of our daily lives. We're always on the hunt for more service bars on our mobile devices because more bars mean a stronger network and better reception—and good reception depends on antennas. For wireless operators, antennas are the vehicles that power network expansion, allowing operators to better serve larger areas, more densely-populated regions, additional spectrum and other avenues of network growth.

The antenna is one of the most critical parts of both the transmit and receive paths, and it's often the most visible part as well. Antennas come in all shapes and sizes because each is built for a specific purpose. However, all antennas share a common link: They are the key to how well—and how far—communications can be shared.

CommScope has been a trusted partner to all kinds of wireless networks worldwide for decades, owing to our deep expertise in antenna design and investment in cutting-edge antenna innovation.



The emergence of base station antenna standards (BASTA)

In 2014, the Next Generation Mobile Networks (NGMA) Alliance published the base station antenna standards (BASTA) for LTE networks. BASTA defined a unified approach in procurement, planning for long-term network growth, and common measurements of network performance across the industry. This has made it simpler and more economical for operators to expand their LTE networks.

As of Spring 2018, NGMA is working on an updated BASTA for emerging 5G networks.

What is an antenna?

At its most basic level, an antenna is the portion of a radio system that can:

1. Take radio energy from a transmission line and radiate it into space in a predictable pattern, and
2. Receive radio energy from open space and feed it back down a transmission line.

Antennas are surprisingly efficient in this line-to-space and space-to-line energy conversion process. In fact, when properly configured with the right components, antennas can yield 80 percent efficiency or greater—a remarkably high figure in engineering terms. By way of comparison, consider the common incandescent light bulb, which yields only 20 percent efficiency—meaning that, of the energy put into a bulb as electricity, only 20 percent is put out as light. An important consideration to maintain an antenna's extraordinary efficiency lies in the transmission cable that connects it to the transmitter.

Matching the line

To get maximum efficiency from a radio transmission's power, the antenna and cable must share certain characteristics to avoid wasted energy. For example, if a radio system uses an industry standard coaxial cable fixed at 50 ohms to connect the antenna and its transmitter, the antenna itself must rate reasonably close to 50 ohms as well.

Testing this configuration is a simple task. We connect the coaxial cable to the transmitter and place a 50-ohm "dummy load" on the other end to simulate an antenna. Using a watt meter will reveal two important factors that measure the efficiency of the system:

1. The amount of power entering the cable from the transmitter, and
2. The amount of power reaching the dummy load.

The difference between these two measurements represents the power lost in the line itself. The better matched the cable, the smaller the difference—and the more power reaches our simulated antenna.

If we reduce the simulated antenna's load from 50 ohms to just 25 ohms, 11 percent of the energy sent through the coaxial cable would be uselessly returned to the transmitter. That would yield very low efficiency—unless we were to replace the 50-ohm coaxial cable with one rated at near 25 ohms, thereby restoring the balance. However, using the 25-ohm cable would simply move the reflection point to the source end where the cable connects to the transmitter.

In a radio system the mismatch of impedance causes energy to reflect back and forth between the transmitter and the antenna. This endlessly reflected power creates a measurable wave pattern in the cable—an effect called the "voltage standing wave ratio" (VSWR).

Antenna

The portion of an RF system that radiates radio energy into space and collects it from space.

Dummy load

A simulated power load applied to an electrical system for testing purposes.

3 | Getting the signal across: Base station antennas

VSWR is the measurement of how well matched a transmission line is to its antenna. Expressed as a ratio, a VSWR of 1.0:1 indicates a perfect match. Likewise, a VSWR of 1.5:1 indicates a 4 percent power reflection, which is another way of describing 96 percent efficiency, where 96 percent of the power output from the transmitter actually makes it to the antenna (Table 3.1).

Voltage standing wave ratio (VSWR)

A measurement of the power reflected between transmitter and antenna in a transmission line that connects the two. This figure yields the system's transmission efficiency.

Calculating voltage standing wave ratio (VSWR)			
VSWR	Return loss (dB)	Reflected power (%)	Through power (%)
1.10	26.5	0.2	99.8
1.25	19.1	1.2	98.8
1.50	14.1	4.0	96.0
1.75	11.6	7.4	92.6
2.00	10.0	11.0	89.0

$$\text{VSWR} = [1 + 10^{((-Return Loss)/20)}] / [1 - 10^{((-Return Loss)/20)}]$$

3.1: Calculating VSWR, and some sample efficiencies

Velocity, frequency and wavelength

Like all forms of radiation, including visible light, radio waves travel about 186,000 miles, or nearly a billion feet or 30 billion cm, per second. Like other forms of radiation, radio waves oscillate, or flip back and forth, between plus and minus at a predictable rate. Each complete flip is called a “cycle,” and cycles are expressed in hertz (Figure 3.2). Measuring how many cycles, or hertz, a signal oscillates per second gives us its frequency—literally, how “frequently” the signal oscillates in one second.

Knowing a signal’s speed and its frequency, we can divide the first by the second to determine its wavelength—the distance the signal travels

while completing one full cycle. Wavelengths are usually measured in feet or inches, and are useful in understanding what it means to be “in phase” or “out of phase,” which we’ll explore later in this chapter.

Antennas are two-way streets

In theory, antennas transmit and receive in precisely the same way; the same processes occur both ways—only the direction is reversed. In actual practice, however, a number of complicating factors, particularly on the receiving end, can impact the efficiency with which the antenna operates.

To demonstrate, it is perhaps easiest to explore the most basic of antennas: the half-wave dipole.

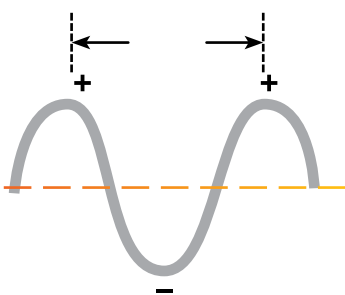

A cycle completes itself traveling from plus to minus back to plus.

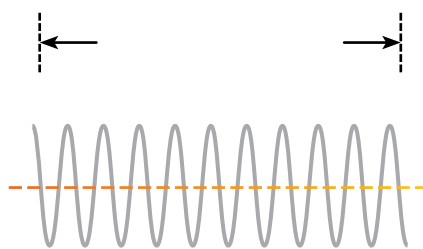

The number of cycles in one second gives the frequency.

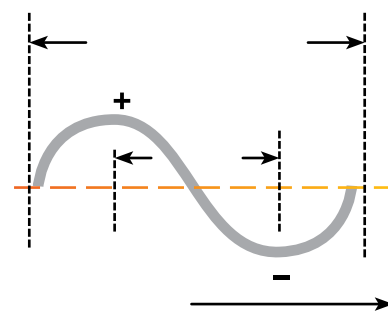

The speed divided by the frequency gives the distance the wave travels in one cycle. This is called the wavelength.

3.2: Relationship of time, frequency, and wavelength

Half-wave dipole

The half-wave dipole radiator antenna, often just called a “dipole,” is the most basic antenna used in two-way base station applications. It is essentially nothing more than a straight conductor made of wire, rod or tubing that measures exactly half of its assigned frequency’s wavelength. A rule of thumb for determining wavelength at a given frequency is:

$$\text{Length (in centimeters)} = 30 \text{ divided by the desired frequency in GHz}$$

As a result, dipole antenna length can be highly variable. It could be just 0.5 cm in length for a frequency of 28 GHz, or 21 cm long for a frequency of 700 MHz. The table below provides more examples (Table 3.3).

Generally, the feeder line is connected at the midpoint, so the antenna radiates at maximum intensity in the middle of the dipole (Figure 3.4).

Frequency (MHz)	1/2 Wavelength (inches)	1/2 Wavelength (centimeters)	Frequency (MHz)	1/2 Wavelength (inches)	1/2 Wavelength (centimeters)
30	196.8	499.9	800	7.4	18.8
50	118.1	300.0	900	6.6	16.8
74	79.8	202.7	1700	3.5	8.9
150	39.4	100.1	1900	3.1	7.9
220	26.8	68.1	2100	2.8	7.1
450	13.1	33.3	2500	2.4	6.1
750	7.9	20.1	3500	1.7	4.3

3.3: Half wavelengths of two-way frequencies

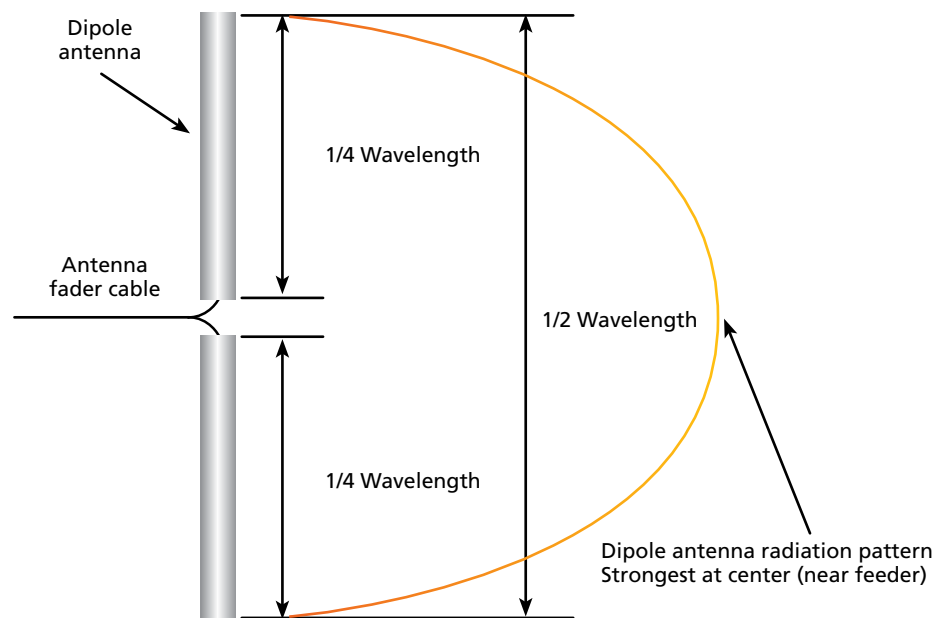

3.4: Dipole antenna construction and radiation pattern

Vertical and horizontal antenna radiation patterns

All antennas, regardless of polarization, have three-dimensional radiation patterns. If the pattern is extended in all directions equally, the resulting shape would be a sphere, with the antenna at its center. The polarization of the antenna determines which portion of that sphere represents an antenna's actual pattern. Slicing the sphere vertically yields a vertical circle, while a horizontal slice would reveal a horizontal circle.

These theoretical descriptions of the two polarization patterns appear to be omnidirectional within their planes, but that's not quite the case. In practice, there are no truly omnidirectional antennas. Our example half-wave dipole antenna, for instance, reveals the truth (Figure 3.5). The pattern appears circular, like a doughnut, on a horizontal plane, but forms a figure-8 in the vertical plane.

As we will see later in this section, most real-world antennas consist of a vertical array of radiating elements—and elevation pattern shaping has become quite important for interference minimization (Figure 3.14).

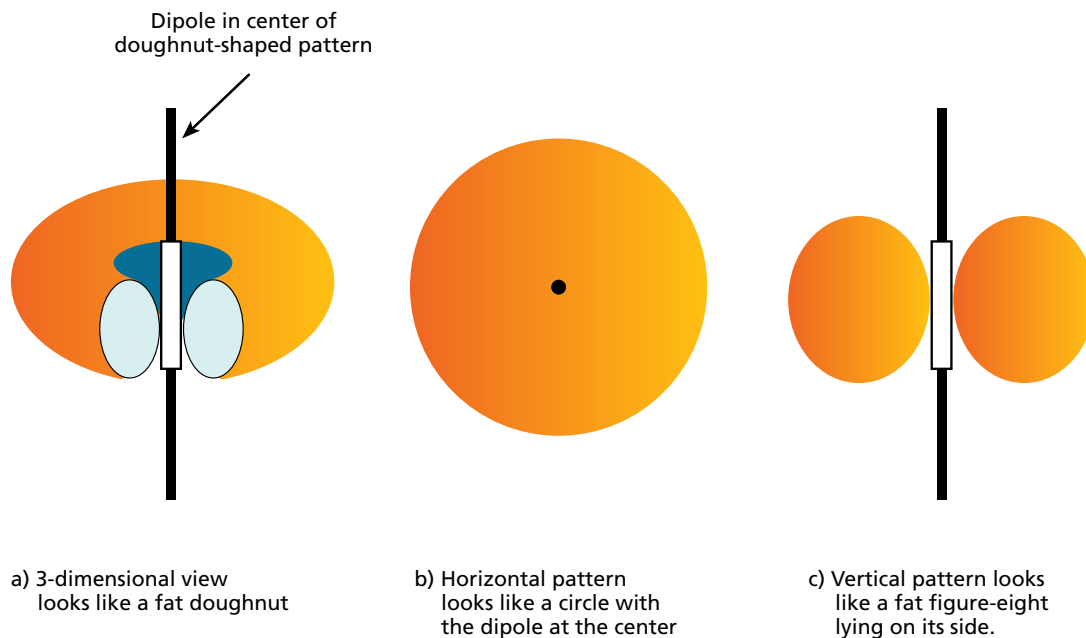

3.5: Radiation patterns for a dipole antenna

Antenna gain

As shown in Figure 3.5, the level of radiated power density varies in space depending on the position relative to the antenna. The ability of an antenna to focus energy in a specific direction is described by two terms, directivity and gain. Imagine that the power input into the antenna was distributed in an even isotropic manner. Directivity describes the level of radiated power density at a specific (theta,phi) coordinate relative to this isotropic radiation. Antenna gain is the maximum value of directivity over the entire sphere. When Antenna gain is measured relative to an isotropic radiator, the value is stated in dBi (dB isotropic). When antenna gain is measured relative to the gain of a single dipole, the value is stated in dBd (dB dipole).

Boosting gain

Since the input power is constant, the only way to increase antenna gain, or maximum power density, is to get more of the energy to go in one direction, and therefore less of the energy to go in other directions. In other words, the goal is to focus more of the radiated power in a single direction. Typically a base station antenna is required to cover a fixed amount of area in the horizontal direction and so that is left as is. But it is normally acceptable to “squash” the pattern in the vertical direction. As the width of the beam decreases in the vertical direction, the power density at the beam peak, the antenna gain, becomes larger.

Power ratio	dB	Power ratio	dB
0.10	-10	1.00	0
0.13	-9	1.26	1
0.16	-8	1.58	2
0.20	-7	2.00	3
0.25	-6	2.50	4
0.32	-5	3.16	5
0.40	-4	4.00	6
0.50	-3	5.00	7
0.63	-2	6.30	8
0.79	-1	8.00	9
1.00	-0	10.00	10

3.6: Deriving gain in dB from power ratios

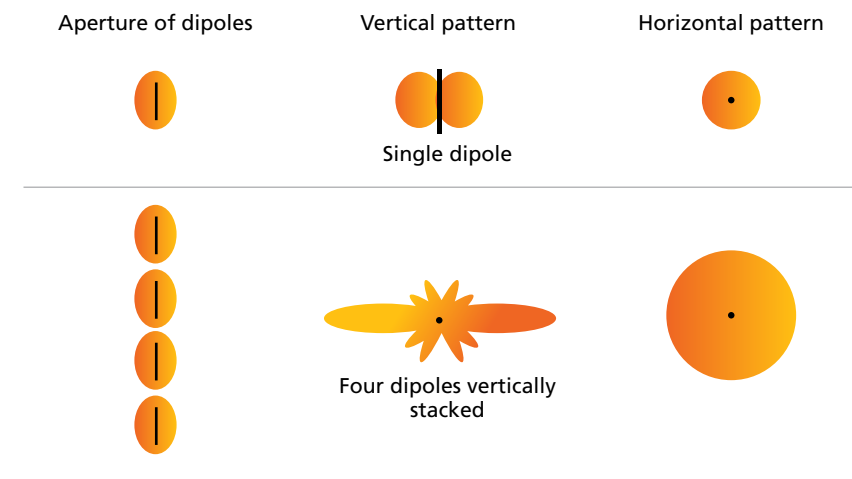

3.7: The maximum distance of the edge of the orange shape from the black dot at the center indicates the gain.

Omnidirectional pattern gain antennas

To achieve greater gain in this circular (or omnidirectional) pattern, we can stack multiple vertical dipole antennas above each other, as shown in Figure 3.7. This increases the vertical size of the antenna.

Then, we feed power to the dipoles in such a way that they add together at a distant point—again, with transmission lines matching their radiation power limits for greatest efficiency.

By feeding equal amounts of power that arrive at each dipole at the same instant, the dipoles radiate “in phase,” or in synchronicity, for improved gain by virtue of its pattern. This type of antenna is called a “vertical collinear phased array.”

Aperture

Beam width determines the gain of an antenna. Like an adjustable nozzle on a garden hose, beam width describes the degree to which the signal is focused: the tighter the focus, the greater the gain within that area of focus.

Spacing of dipole elements

In a vertical collinear array, each dipole or sub-array of dipoles is connected in parallel to the common feed point by a separate transmission line. This means it's possible to locate the dipoles so their vertical separation tightens overall beam width to boost gain. This separation is usually something between one half and one wavelength of the assigned frequency being transmitted. Anything less tends to reduce the improvements in gain.

Feeding the array

In a vertical collinear array of two or more dipoles, the most common means of feeding power via the coaxial transmission lines is the parallel (shunt) feed. Power is fed along individual lines to each dipole or sub-array of dipoles. Using matching transformers and junctions, the cables connect to the line running down the tower. This allows the array to be fed from the center, equalizing the effectiveness of each array element and preventing the beam tilt that affects series-fed installations.

Directional gain antennas

While omnidirectional gain antennas like the vertical collinear array achieve greater gain by compressing its vertical pattern into a flatter circular shape, there are other types of antenna that modify their horizontal patterns to accomplish the same gain improvements.

In phase

Multiple antennas radiating together at precisely the same time and rate.

Dipole and reflector

As we've shown, a vertical dipole antenna has a circular horizontal pattern. However, if we position it in front of a metal screen or wire mesh, we see that radiation going to the rear will be blocked (Figure 3.8). If this blocked radiation is reflected off this screen, the horizontal pattern will no longer be circular, but directional.

If a dipole is positioned exactly one-quarter wavelength from this reflection screen, the radiation that would ordinarily go to the rear is redirected to the front to form what is called a "directional lobe." It's the same effect as that of the reflective mirror behind a flashlight's light bulb, which redirects the circular light pattern into a single direction. The larger the screen, the greater the reflection and the narrower the directional lobe becomes—and, just as the omnidirectional antenna increases gain by compressing vertically, this directional antenna increases gain by compressing horizontally and directing all its power in a single direction.

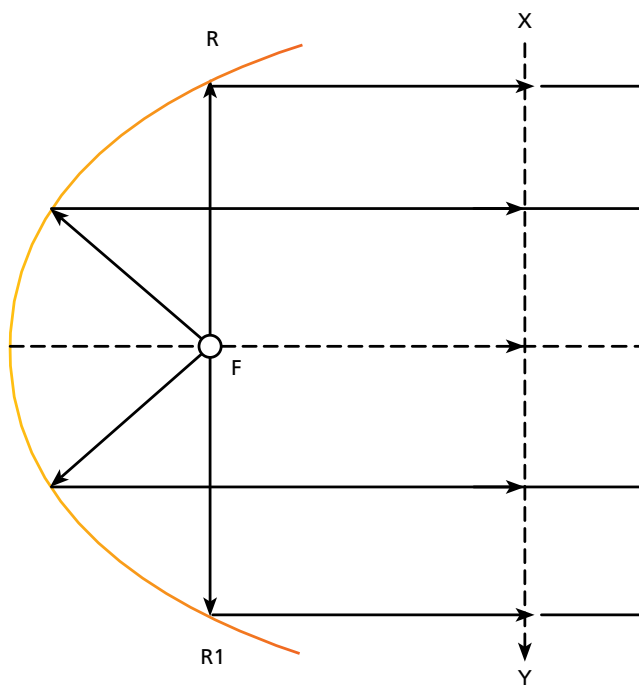

3.8: The omnidirectional pattern of a dipole can be made directional

The bandwidth factor

Another consideration in antenna construction is that of bandwidth. As we discussed in our description of the dipole, antennas must be built to lengths determined by their operating frequency wavelengths. As you may recall, the dipole antenna must be half the length of its assigned wavelength. However, it is possible to build an antenna that covers a range of frequency bands—or bandwidth—centered on a particular frequency.

Indeed, nearly every antenna in use today affords a fairly wide percentage of bandwidth. In fact, certain antenna designs in the 1900 MHz frequency range can offer over 61 percent bandwidth (1427–2690 MHz). These are known as ultra-wideband antennas.

Cellular antenna concepts

Now that you have a basic working knowledge of antennas and how specific configurations can help them perform even better—that is, by improving gain—let’s look at a much more specialized and sophisticated category: the cellular antenna.

Cellular antennas are a familiar feature in nearly every corner of the world. In many cases, these are cellular networks that bring new connectivity where it had never before been possible—and these connections depend on cellular base station antennas.

In cellular base stations, there are two basic antenna types currently in use (Figure 3.9):

1. **Omnidirectional antennas**, which we defined previously as antennas that exhibit a circular radiation pattern and operate in virtually all directions, and
2. **Directional (or sector) antennas**, which operate in a specific direction, most commonly covering an arc of 120 degrees or less, depending on capacity requirements.

Figure 3.9 shows older legacy sites using vertically polarized antennas. Rural sites typically used 90-degree horizontal beamwidth models; suburban sites used 65-degree models; and urban sites used models ranging from 33 degrees to 65 degrees. In these cases, two Rx antennas were required per sector to support Rx diversity. For modern sites, a single dual-polarization (± 45 degrees) model with the appropriate horizontal beamwidth supports Rx diversity.

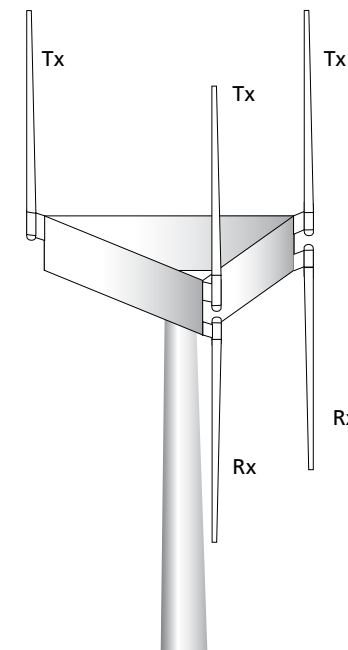

Omnidirectional antennas

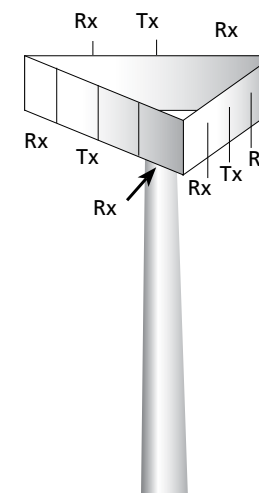

Directional antennas

3.9: The two types of commonly-used cellular base station antennas

Cell reuse

What makes cellular networks different from other types of communications is the principle of cell reuse. Cell reuse is a way of increasing network capacity by “reusing,” or reassigning, individual frequencies on the fly within a particular cell.

To see this process in action, consider the shape of cells and how they fit together. Typically, cells are represented as interlocking hexagons, as seen below (Figure 3.10). Depending on the density of the area served, these hexagons can be miles across or cover just a few hundred feet.

As a result of this incredible flexibility, channel sensitivity is limited by external interference rather than noise issues, as older radio communications have traditionally been. The specialized pattern shaping available with directional antennas—both in azimuth (horizontal direction) and elevation (vertical space)—allows incredibly precise coverage that doesn’t interfere with neighboring cells.

Antenna characteristics

A cellular base station’s antenna is the most critical consideration in an efficient cellular network, and it all depends on choosing the antenna with exactly the right physical characteristics for a specific application. These characteristics relate to radiation pattern, antenna gain, front-to-back ratio and a number of other critical factors.

In the real world, defining, choosing and testing these characteristics requires a great deal of technical expertise and mathematical skill; so, for the purposes of this discussion, we will cover the basics with a far more generalized approach than an engineer would use in an actual evaluation.

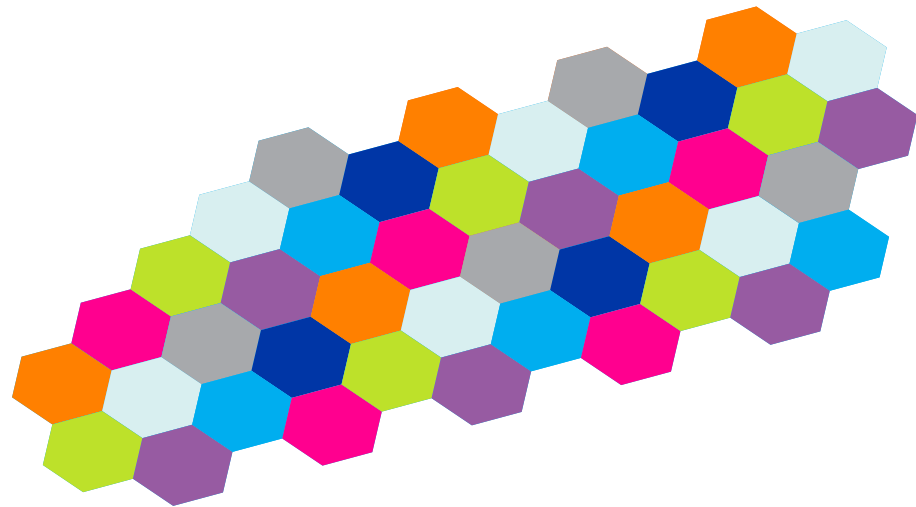

3.10: Cell reuse in a sample map

Radiation pattern

Perhaps the most obvious and important characteristic to understand is an antenna's radiation pattern. If a particular application calls for coverage in all directions, you would choose an antenna with a circular or omnidirectional radiation pattern. If your installation requires a more focused signal, a directional antenna's radiation pattern would satisfy your needs.

Mapping an antenna's radiation pattern is a fairly simple task. Connecting a probe antenna to a receiver and moving it around your tested antenna at a fixed distance allows you to see the variations in signal strength. Mapping these readings with polar coordinates yields a three-dimensional map showing in which directions the antenna transmits most strongly (Figure 3.11). In reality most ranges keep the probe antenna fixed and rotate the antenna under test using a system containing two rotational positioners, for example azimuth over elevation.

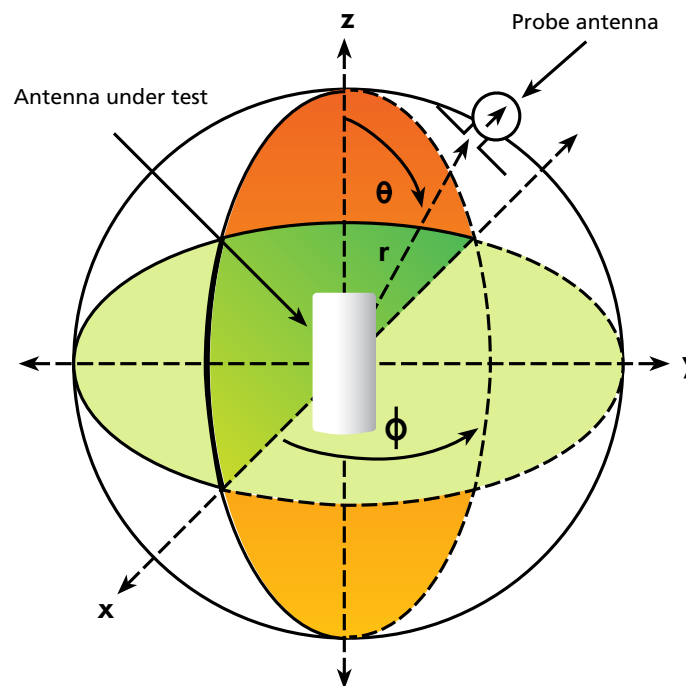

3.11: Moving a probe antenna around the tested antenna at a fixed distance yields a three-dimensional map of its radiation pattern

Radiation pattern

The three-dimensional shape of an antenna's strongest signal transmission.

Spherical coordinate system

A geometric polar coordinate system used to mathematically map the radiation pattern of antennas.

Azimuth coordinate system

The polar coordinate system used in the field by RF engineers and surveyors to map the radiation pattern of antennas.

3 | Getting the signal across: Base station antennas

At the same time, a pattern can also be expressed as a conventional rectangular plot with angular position on the X-axis and signal strength on the Y-axis. Examples of both are shown below. Depending on the design of the antenna, the radiation pattern can display any number of shapes. The isotropic dBi reference is a theoretical “point source” and thus generates a pattern covering all directions of a sphere. As seen previously, the half-wave dipole dBd reference pattern has nulls above and below

the dipole and, thus—from a conservation of energy standpoint—must have more gain on the horizon than the dBi reference. The absolute difference of these two standards is 2.14 dB but, today, most manufacturers rate their products in dBi. Since an antenna’s gain is determined by comparing it to one of these standards, the dBi rating will always be 2.14 dB greater than the dBd rating.

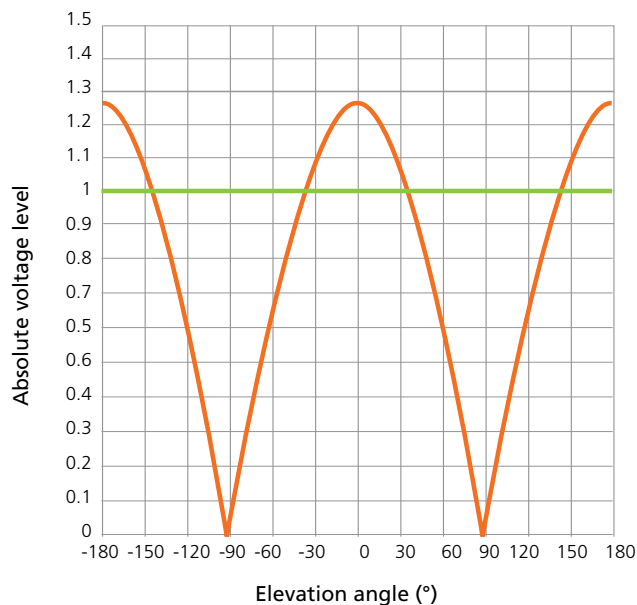

— Isotropic radiator
— Half-wave dipole

Polar plot center = 0
0.2 units/radial division
15°/angular division

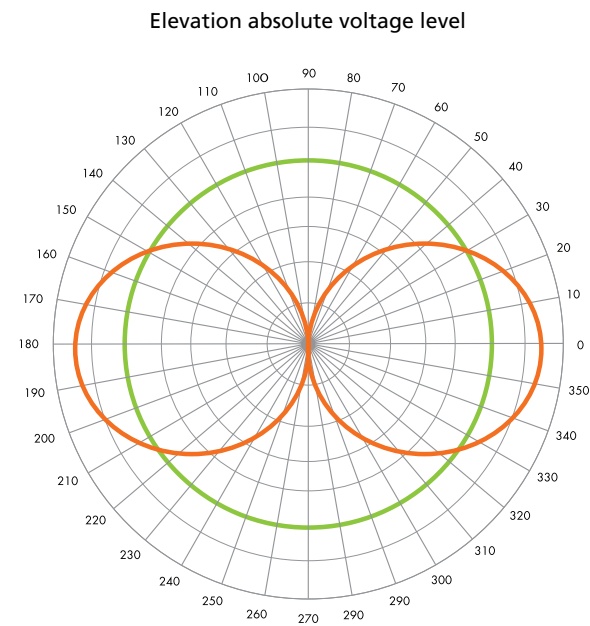

3.12: Rectangular and polar vertical pattern plots comparing isotropic radiator vs. half-wave dipole

Antenna gain

As discussed earlier, an antenna's radiation pattern is directly connected to its gain. As we increase the size of the antenna's aperture, the pattern becomes more "squashed" and the gain increases. For example, doubling the area of the aperture results in a doubling of antenna gain, or an increase of 3dB whether measured in dBi or dBd—though, as a practical matter, larger antennas introduce efficiency-reducing power losses that diminish the gain improvement.

Front-to-back ratio

The ratio of a directional antenna's maximum directivity to "front" (where its main lobe appears) to its "back" (where its reflector is located) is called, appropriately, the antenna's front-to-back (F/B) ratio (Figure 3.13). Note that F/B can be defined several different ways. For example, it could be defined based on the co-pol pattern, on the worst case of the co-pol and x-pol patterns, or on the total power pattern (so the addition of the co-pol and x-pol patterns). In addition, F/B can be defined so the "back" is defined as the worst case value over a sectoral range around the 180-degree azimuth point. So, for example, the BASTA committee has defined F/B as "total power over the 180 ± 30 -degree sector:"

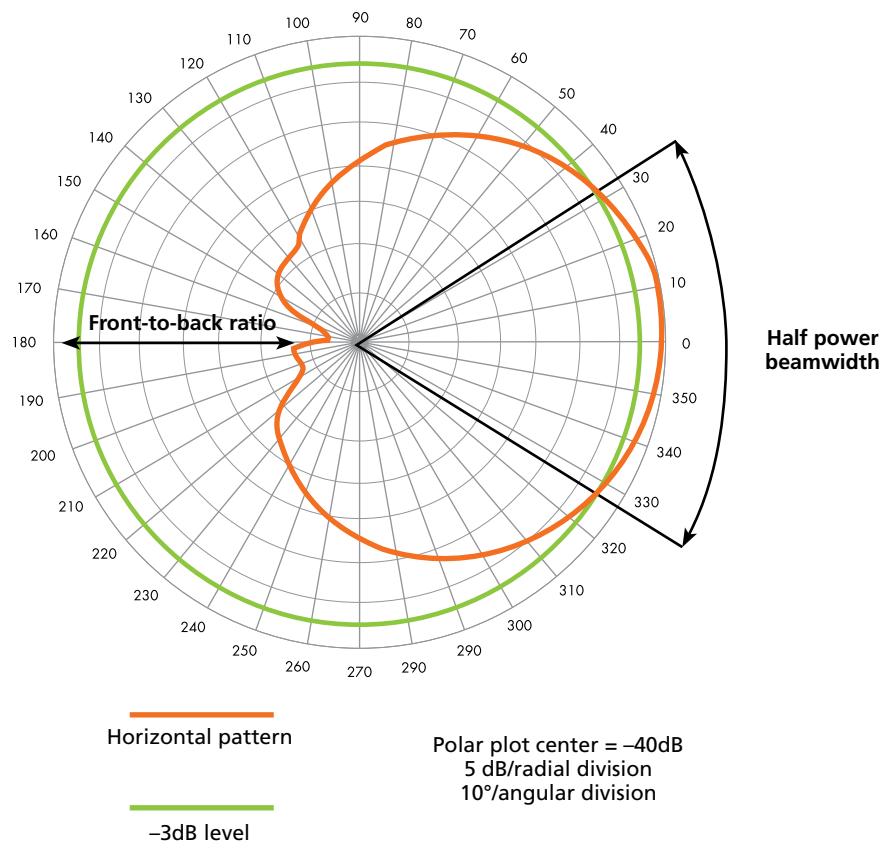

3.13: A polar representation of a directional antenna's front-to-back ratio

Sidelobes and nulls

Apart from a radiation pattern's main lobe, there can also exist sidelobes and nulls. Sidelobes are extraneous areas of strong signal, and nulls are the low-energy spaces between them (Figure 3.14). Nulls may exhibit 30 dB or more of attenuation, meaning signals found there can be as weak as one one-thousandth of the power of the main lobe.

There are ways to adjust the amplitude and phase going into each element so as to reduce the power contained in one or more sidelobes, reducing potential interference. This typically results in a widening of the main lobe, which will reduce gain. There are also ways of redirecting sidelobe power into the area with the null. This process is called "null fill" and it typically results in a reduction in gain.

Polarization

Polarization is a property of the wave produced by an antenna that describes the way that wave varies in space over time. In simpler terms, it describes the orientation of that wave, such as vertical or horizontal or slant 45 degrees (dual-polarization).

Cross-polarization ratio

This characteristic measures the performance of a dual-polarized array in distinguishing between orthogonal waves (two signals broadcast perpendicular to one

another, such as horizontally and vertically). This figure is calculated as the ratio of co-polarization to cross-polarization occurring in the antenna's main lobe (Figure 3.15).

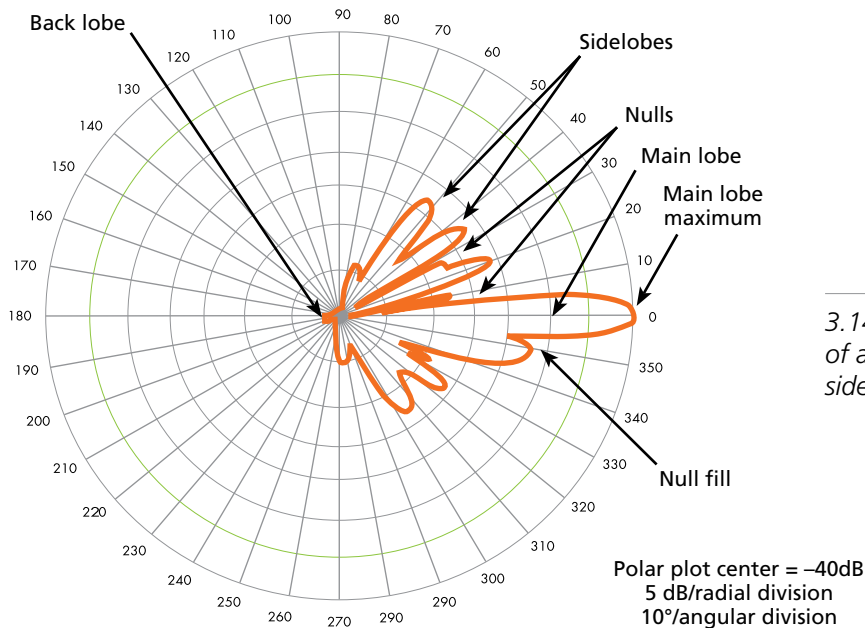

3.14: A polar representation of a vertical pattern including sidelobes and nulls

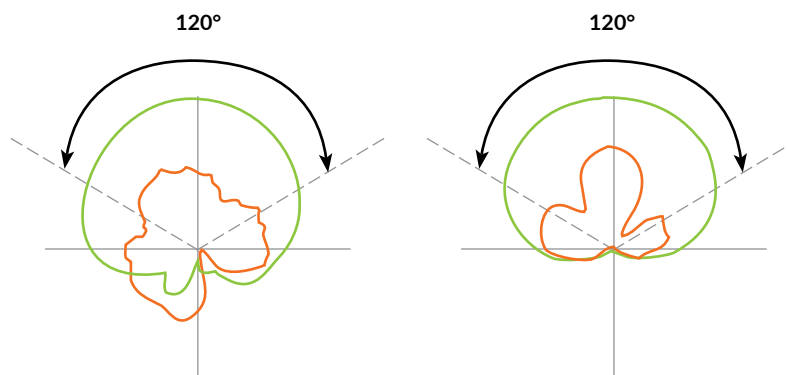

3.15: Typical and directed dipole cross-polarization ratios

Sector power ratio (SPR)

Basically, sector power ratio is a comparison of signal power registered outside and inside a desired receiving area as a consequence of an antenna's radiation pattern (Figure 3.16). The lower the ratio, the better the antenna's interference performance.

As a practical matter, particularly in cellular network applications, higher sector power ratios indicate a higher amount of interference between antennas in adjacent coverage areas. When competing signals overlap, interference can increase and reduce performance—such as dropping a cell phone call while moving from one cell to another. Cellular networks require precise sectorized planning to prevent this kind of problem.

Beamtilt

As capacity requirements increase, one solution is to split the hexagons shown in Figure 3.10, allowing the addition of more sites and reducing the coverage radius of the original site. To accomplish this, elevation beam downtilt is commonly used to reduce the gain on the horizon (and thus the coverage radius) as shown in Figure 3.17. Mechanical downtilt results in undesirable pattern distortion on the horizon while electrical downtilt maintains the desired pattern shape.

Early antennas incorporated fixed electrical downtilt, but this required multiple different models. State-of-the-art

antennas today have adjustable electrical downtilt, which can be adjusted remotely using the architecture and standards published by the Antenna Interface Standards Group (AISG).

Cellular antennas on a practical level

When we move beyond the drawing board of theoretical antenna design to the real world, we soon discover that the laws of physics are not the only limiting factors affecting an actual installation. These issues include everything from tower weight and wind limits to local zoning board approvals for antenna size, shape, height and appearance. In most installations, compromises are necessary to satisfy all the competing interests.

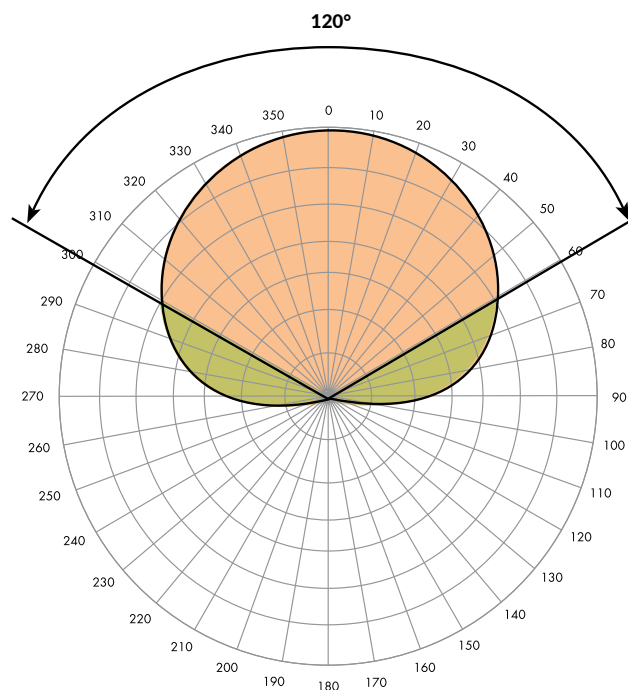

3.16: Graphic and mathematical representations of an antenna's sector power ratio

3 | Getting the signal across: Base station antennas

Most cellular antennas are produced in a variety of physical sizes to offer the best performance while conforming to other requirements. Chances are you've seen cellular antennas mounted in a number of ways, featuring diverse sizes and designs—such as the commonly used lengths of 4, 6 and 8 feet. Outside the U.S., common lengths are 1.4, 2.0, and 2.7 meters.

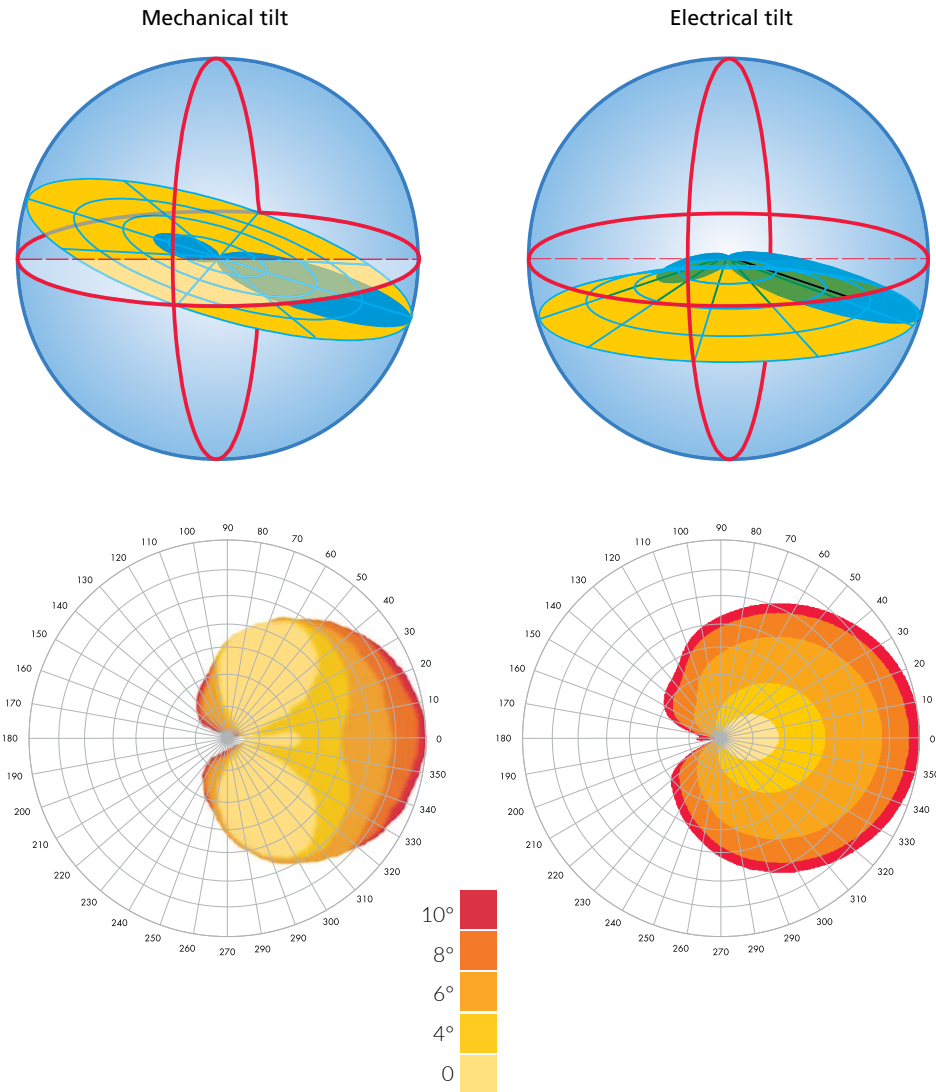

3.17: Tilting the antenna changes the shape of the lobe at ground level, reducing gain

Antenna profiles and tower/wind load

The size and shape of an antenna dictate not only its function, but also how much stress it places on its mounting location. Because cellular base station antennas are typically located high above ground level, they experience greater wind speeds—particularly gusting winds—than anything one might experience at the base of the tower. Antennas act like sails, catching this wind on their flat surfaces to create “wind load,” a measurement of the stress wind places on the tower’s structure and the antenna’s mounts. Therefore, where possible, antennas should be designed with the smallest, most aerodynamically efficient form factor.

A smaller size also means less weight, which improves the antenna’s “tower load” characteristics, or the combination of the antenna’s weight plus the force generated by wind loading. All cell site towers have a maximum load rating; so, by adding antennas, one reduces the tower’s remaining load budget. This is increasingly important as more and more cell site equipment is being mounted on the tower instead of in the shelter at the base.

Materials and environment

Cellular base station antennas are only as reliable as the materials that go into their construction and the construction of their arrays. When it comes to working

with the physical limitations of an antenna’s location, matching the right materials to the environment is a critical consideration. Here are just a few examples.

In the antenna array itself:

- Aluminum alloys offer lightweight strength, but can be vulnerable to the elements.
- Pressure-cast aluminum is well suited to bases, sockets, mounts and clamps, where its hardness and resistance to corrosion are critical.
- In circumstances where weight is not a serious factor, copper and brass are used for their easy plating and conductivity properties. However, they need to be protected to prevent corrosion.

Antenna radomes:

- High-strength, low-RF loss materials such as fiberglass—or thermoplastics such as ASA or PVC—offer protection from the elements.
- Materials must offer UV protection to prevent deterioration due to sunlight exposure. This can be done via a coating or by adding UV inhibitors to the base polymer.

Tower appearance:

- For purposes of appearance and regulatory compliance, nonmetallic paint can be applied to the entire structure.
- For better wear, smooth surfaces should be roughed prior to painting.

These are just a few of the more obvious physical considerations. Other matters in cable selection, connector choice and termination options demand close attention as well.

More capacity with fewer antennas

As mentioned earlier, cellular antennas are directional, often covering 120 degrees, or one-third of a complete circle. Mounted together on a triangular tower, these antennas can cover all directions. But, in densely urban areas that require more capacity, narrowbeam antennas used in sector splitting schemes can handle additional traffic—adding to the cost by adding more antennas. Having so many antennas in a single location makes it more likely to run afoul of local zoning codes as well as introduce troublesome tower weight and wind load concerns.

Capacity can be increased without adding more antennas by opting for multibeam antennas—a single antenna system that splits the main beam into precisely-spaced narrower beams. Multibeam antennas are particularly effective in areas of high network demand.

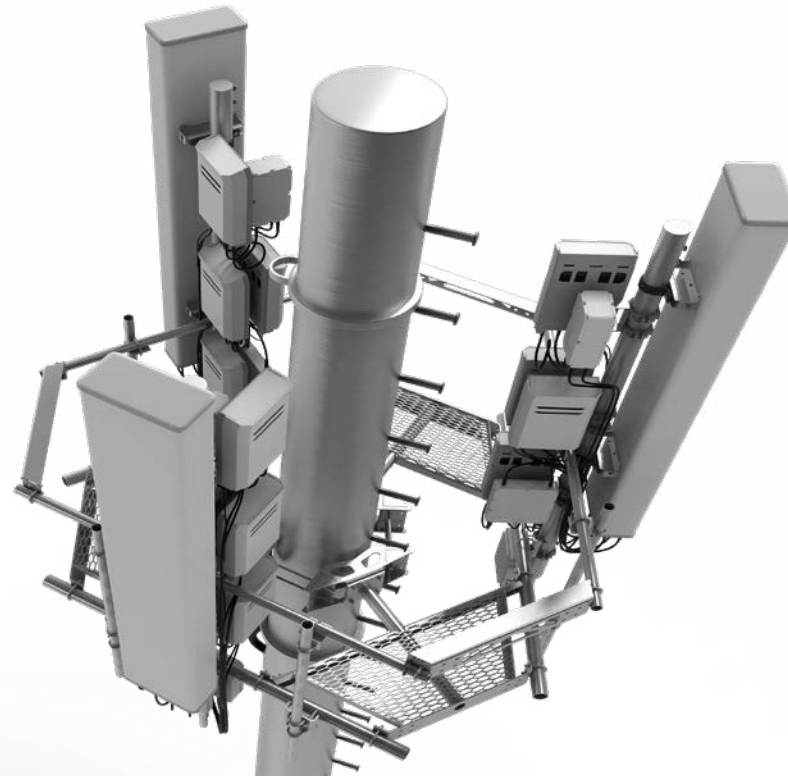

Twin-beam

One example of multibeam technology is the twin-beam antenna from CommScope. It produces two separate 35-degree beams with centers separated by 60 degrees. As the illustration below shows, this dual-lobe approach provides excellent coverage and only requires three twin-beam antennas instead of six narrowbeam antennas to

provide a six-sector scheme (Figure 3.18). Similarly, three tribeam antennas can be used to do the work of nine narrowbeam antennas in a nine-sector scheme. This advantage means smaller, less conspicuous deployments that offer better tower weight and wind load factors for sector splitting applications.

"Six-sector" sites

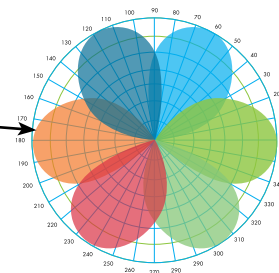
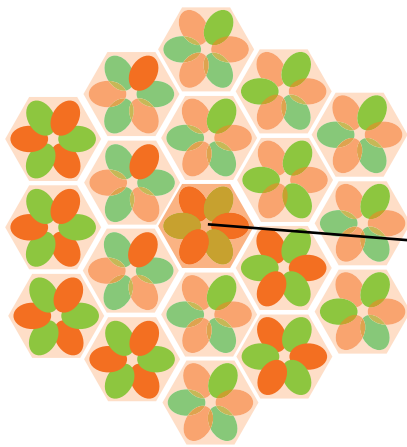

65° antenna vs. twin-beam antenna

Traditional 65° pattern

Better roll-off

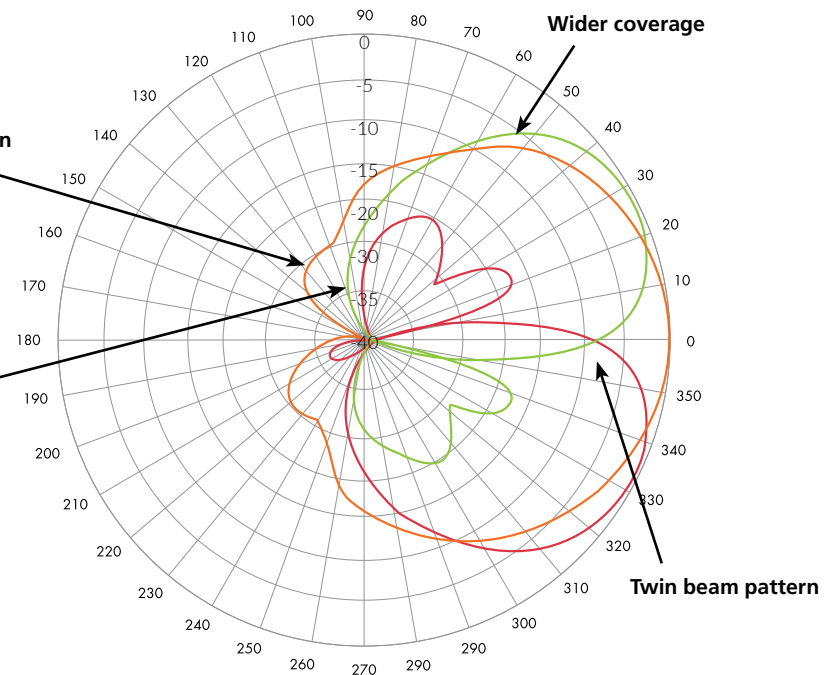

Twin beam advantages

- Back-to-back broadcast channel (BCCH) re-use capability
- Enhanced RF footprint (higher gain)
- Better interference containment (better roll-off)
- Easier zoning and faster site deployment

3.18 Same number of antennas, double the coverage—a 65° pattern compared to a twin-beam installation

Beamforming

Beamforming is the concept of using a multi-port antenna and generating correlated amplitude and phase weights in the radio to produce narrower beams that optimize the SINR by either increasing the link budget to the intended UE or by decreasing the link budget to other UEs that may generate interference. This increases both capacity and coverage in the network, improving spectrum reuse and reducing interference.

Adaptive array

This capacity-boosting option incorporates several vertical elements that steer a beam toward each user on a tightly managed time-division basis. In this application, each user owns a particular time slot to move his or her traffic. Of course, managing this system for a large number of users requires powerful and sophisticated digital processing, but it also holds the potential to effectively “null out” nearby interference for better high-speed throughput (Figure 3.19 on the next page).

MIMO

New technologies are being developed and deployed at a dizzying rate. The current field of cutting-edge networks is collectively known as “long-term evolution” (LTE) networks. LTE has the potential to completely reshape how networks can perform, because it incorporates a concept called “multiple input, multiple output” (MIMO), which splits data transmission into multiple streams and sends them at the same time on the same frequency using multiple de-correlated RF ports.

What makes this development so exciting is that MIMO offers a way around a classic limiting factor of RF communications known as Shannon’s law, which dictates how much throughput can be delivered down a given amount of bandwidth. As Figure 3.19 on the following page shows, you can only expect to get to within 3 dB of a bandwidth’s theoretical maximum in a practical application.

Shannon’s law

Created by Claude Shannon and Ralph Hartley, this law establishes a theoretical limit to how much data can be reliably pushed through a given amount of bandwidth.

3 | Getting the signal across: Base station antennas

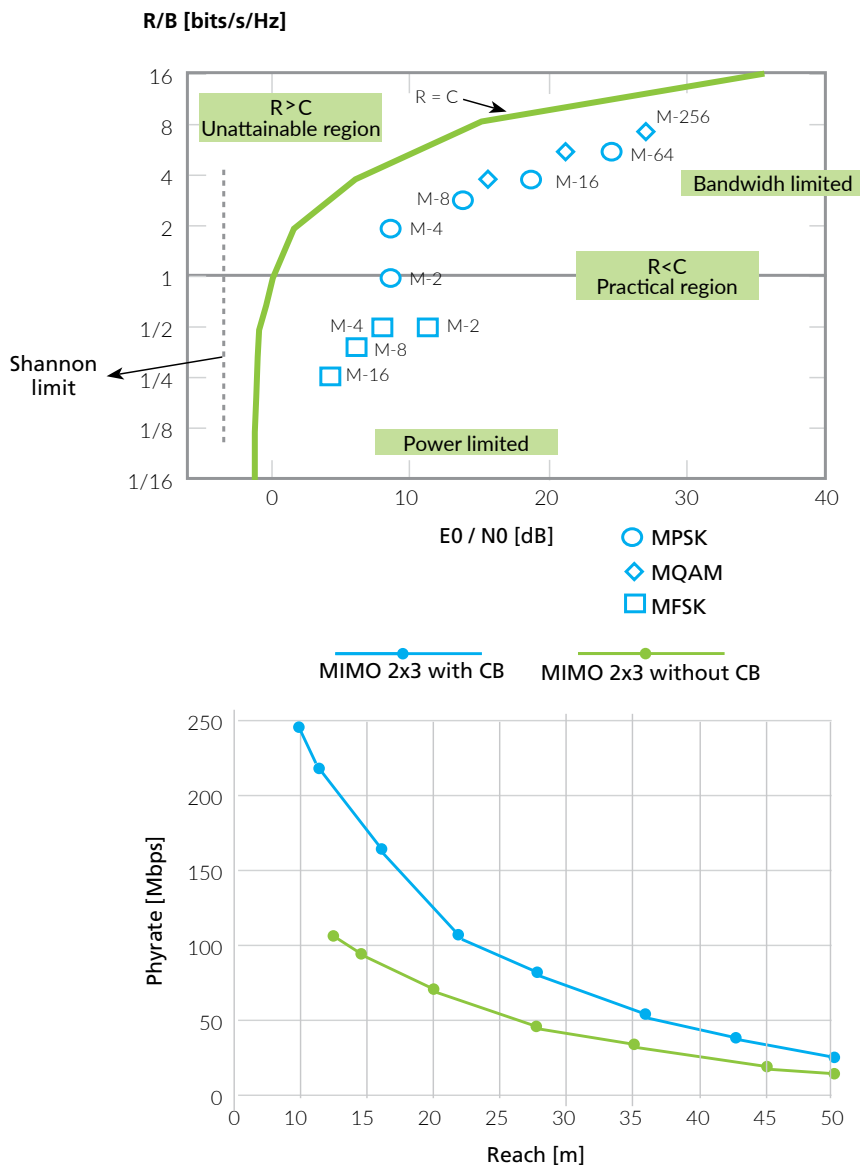

3.19 A traditional plot of Shannon's limiting law

TR configuration and MIMO rank

A TR configuration refers to the number of radio transmitters and receivers in one sector. As the number of Transmitters increases, as the base station gets higher capabilities in transmit diversity, MIMO transmission modes and beam steering.

A MIMO rank describes the number of streams (layers) entering and exiting a communications channel, for each duplex mode. For a DL 4x4MIMO, four streams enter and four streams exit the air interface in the Downlink direction.

2T2R, 2T4R, 2X and 4X MIMO

2T2R, 2T4R, 2X and 4X MIMO 2T2R refers to the base station radio's configuration to transmit on two separate streams and receive on two separate streams.

2T4R refers to a base station radio's configuration to transmit on two separate streams and receive on four separate streams.

2X2 and 4X4 MIMO refer to the one-way link configuration to transmit and receive the respective number of streams. For example, 2X2 MIMO refers to the transmitter having the ability to transmit two separate streams and the mobile to receive two separate streams.

2X and 4X MIMO refer to the base station radio transmitter configuration without discussing the mobile receiver configuration.

3 | Getting the signal across: Base station antennas

MIMO circumvents this limit through digital signal processing (DSP), which can distinguish between the two split signal paths and reassemble them into the original data on the receiving end. This workaround literally doubles the theoretical limits defined by Shannon's law when applied in a 2x2 MIMO configuration with two transmit and two receive antennas (Figure 3.20).

It is quadrupled in a 4x4 MIMO configuration with four transmit and four receive antennas. Actual throughput improvements do not quite achieve this degree of volume, but that differential is to be expected in any practical application of theoretical performance.

MIMO systems
2 x 2 SU-MIMO: Spatial multiplexing

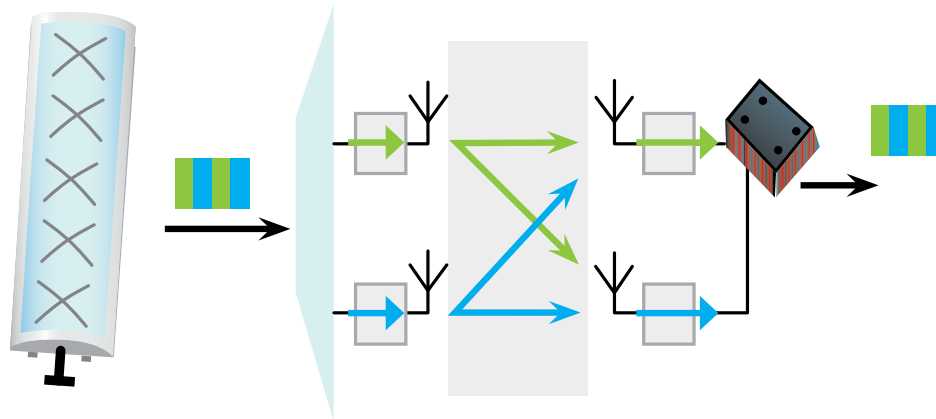

Same time and frequency resource

- Multiple input multiple output
- Capacity gains due to multiple antennas at both ends of the link
- Multipath provides additional channel using DSP
- LTE supports 1x2, 2x2, 4x2, 4x4
- Spatial multiplexing requires a multi-path environment

Different data streams

- Space Time Block Coding is a transmit diversity mode used when SINR levels cannot support spatial multiplexing
- Decorrelation between antennas and propagation paths required for spatial multiplexing
- A dual polarized BSA for 2x2 MIMO; two separated for 4x2 or 4x4 MIMO
- Alternatively, vertically polarized antennas can be used with spatial separation

3.20: This 2x2 MIMO system uses digital signal processing to circumvent theoretical throughput limits

Massive MIMO and 5G

MIMO's capacity-magnifying effect sees its ultimate expression in massive MIMO, which is already coming to market in certain parts of the world. Scaling up the grouped antenna architecture of MIMO to include dozens, hundreds or thousands of antennas has proven to yield remarkable improvements in network speed, capacity and efficiency, even as they reduce deployment costs by using less-expensive antennas.

In the spring of 2017, wireless operator Sprint teamed with Samsung Electronics to deploy massive MIMO sample sites in the United States. Dozens of antennas at each site worked in MIMO configurations to increase a single channel's capacity by 300 percent. About the test, Sprint's representative remarked that a single 20 MHz channel was able to deliver throughputs exceeding 300 Mbps—a feat that would require three aggregated channels across a conventional 8T8R MIMO architecture.

This degree of capacity and speed will be essential to the coming rollouts of 5G wireless services, which will require vastly increased performance and lower latency than current LTE wireless networks.

The basics of base station antennas

Incredibly diverse and remarkably efficient, antennas are the most critical link in any communications network. Radiating radio energy into space and collecting it from space, they can connect a single network backbone or thousands of individual users.

By virtue of their design, antennas can cover virtually any desired area of any shape. But it takes a lot of insight, knowledge and planning to get the most out of every watt. It all comes down to understanding your application's needs—and its limitations.

With your new understanding of how antennas work, and how their performance is measured and compared, you may think twice the next time you are searching for more “bars” on your cell phone. Then look up at the next cell phone tower you see and remember the complexity of the invisible processes that make modern communications possible around the world every day.

Chapter 3 summary

Antennas:

- Structures that radiate and receive radio energy
- Can achieve 80 percent efficiency or greater
- Directional (sectorized) or omnidirectional

Performance characteristics:

- Radiation pattern
- Polarization
- Gain
- Beam width

Enhancements through design:

- Vertical stacking
- Element spacing
- Horizontal pattern shaping
- Downtilt

Cellular base station antennas:

- Sectorized, grouped antennas commonly covering 120 degrees or less
- MIMO and LTE technology represent next step in speed and reliability

Working within the limits: Co-siting solutions

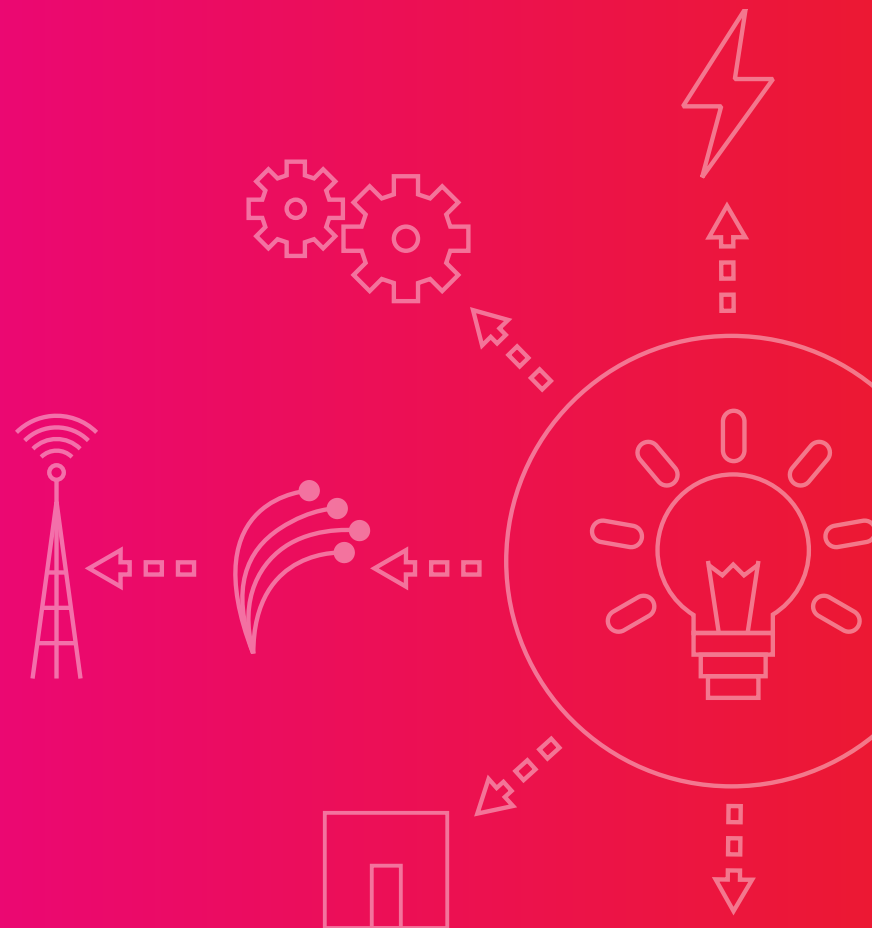

Chapter 4

Carpooling neighborhood kids to school is a great way to manage household costs—under the right circumstances. It allows more people to be moved with less infrastructure, for each participant to spend less on gas, and also helps reduce the overall density of traffic on the road. However, it's not always the best solution. Carpooling also limits where and when passengers can go, reducing overall flexibility in routing, speed and efficiency.

This tradeoff between cooperative advantage and individualized flexibility applies to wireless networks as well. Here, “carpooling” is co-siting.

The economic case for co-siting wireless network infrastructure can be pretty compelling. With space at a premium, there are real incentives to reducing your equipment footprint and the associated OpEx; but every square foot saved places new constraints on the way that base station operates. Since every site has unique limitations, it can be a challenge to identify and implement the best co-siting solutions that optimize the balance of benefits for all concerned.

Going back to our initial carpooling metaphor, we can think of different sharing models available to suit our participating families. For instance, they might split their vehicles cost and recruit a shared driver. They can even sell their vehicle's and hire a taxi company to drive their kids for a monthly fee (corresponding to a tower companies model). More on these models below.

Whatever the specifics of a given cellular installation may be, CommScope offers a wide range of solutions that meet virtually any installation requirement. It takes a combination of technology and insight to make the best of every situation.

Dealing with the realities

Just as it would be supremely convenient to have your own vehicle and driver, it would be ideal for cellular base stations to be equipped with their own dedicated towers, antennas and feeders at every cell site (Figure 4.1A).

If such an arrangement were possible in every installation, the benefits could include:

- Individually optimized antenna pattern, azimuth direction and downtilt angle
- Minimal RF path loss and signal mismatch

Co-siting solutions

The technology and practices that allow multiple operators or technologies to share a physical site architecture

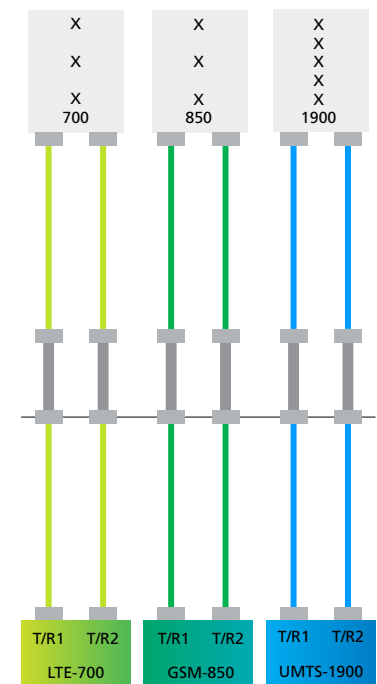

4.1A: Multiband sector with separate feeders

4 | Working within the limits: Co-siting solutions

- Reduced interference and intermodulation between systems
- The ability to perform maintenance on one system without impacting the others

Sadly, this arrangement isn't a practical option for most real-world designs. When a cellular base station makes the move from the drawing board to the tower installation, its design becomes subject to an incredible number of variables and limiting factors. Some of the more common limits are:

- Local zoning ordinances that restrict quantity, size and location of antennas
- The tower's structural weight limits and wind load restrictions
- Budget constraints that limit both the initial (capital expenditure, or CapEx) costs and ongoing (operational expenditure, or OpEx) costs
- Scheduling demands that require accelerated service rollouts

Network sharing models

Network sharing has been in use since the early 2000s when it was used to mitigate the onerous costs of deploying new 3G infrastructure in Europe. It gained additional importance when 4G/LTE deployments began to heat up there in 2015, again in response to costs.

In general, network sharing is a cooperative agreement between two or more wireless operators to use common infrastructure including, antennas, backhaul capabilities, base stations and even core networks themselves. It's estimated that these arrangements can reduce CapEx and OpEx spending by 10 to 40 percent for each participating operator.

The major driver of network sharing continues to be the potential for cost savings. The amount that an operator can save depends upon the depth of the sharing arrangement. Options range from real estate and infrastructure to active forms in which a common RAN network, spectrum resources and core networks may be shared among MNOs. The potential cost savings and benefits increase as the depth of the sharing increases, but so do the risks. An overview of the most common network sharing models is illustrated in Table 4.1B.

Site sharing	Civil infrastructure
	Backhaul
Passive sharing	RF path
	Antennas
Active sharing, MOCN, MORAN	Base station
	Controllers
	Spectrum
GWCN	Core network

4.1B: Popular network sharing models

Despite some 3GPP efforts, there are no standard sharing terminologies, architectures or classifications in the industry. Encountering different names for the same sharing type is very likely. Even the term “sharing” itself is referred to by “colocation” in some markets. However, all terminologies involve three main sharing categories:

- **Site sharing.** Shared assets may include the physical real estate for the site, space on a tower, cabinets or enclosure spaces and any utility connections supporting the site. This has become an extremely common practice, and is even mandatory in some markets.
- **Passive sharing.** This is the sharing of passive, or non-electronic, components needed to support a cell site such as antennas and transmission lines, tower-mounted amplifiers and other RF conditioning equipment.
- **Active sharing.** This refers to the sharing of active electronic infrastructure and radio spectrum used in the RF path, such as base station radios and controllers, as well as operational resources such as maintenance, radio design and planning. Operators can share not only spectrum, but core network, infrastructure management systems, content platforms, and administrative resources like billing systems and even customer service platforms as well. Less common than passive sharing, it is nonetheless

becoming more widespread to support 4G/LTE rollout costs. More on this follows below.

- **National roaming.** This is the practice of sharing responsibility for coverage and capacity by dividing costs between participating operators based on geography, in some ways like how separate railway lines share coverage of specific routes and areas with each other in a mutually beneficial way. This practice also gives entrée to new operators who do not own a physical network, but can contract to ride on another operator’s infrastructure to ensure consistent QoS and equitable pricing.

Passive sharing techniques

Multiband combining

One frequently used passive sharing technique is called “multiband combining,” a method of frequency multiplexing. It takes advantage of the fact that feeder cables are naturally well suited to being shared by multiple frequency bands. In other words, multiple base station services can be funneled into a single feeder cable that runs up the tower to the antennas. Those services can then be split away from that one cable directly beneath the antennas.

To visualize this concept, think of how you bundle your home or office computer’s wires into a single plastic cable wrap. At one end, the cables separate into various ports on the back of your computer. On the other end,

3rd Generation Partnership Project (3GPP)

A collaborative coalition of telecom associations originally formed to create global 3G specifications. 3GPP has since added standards for 4G/LTE and other technologies.

4 | Working within the limits: Co-siting solutions

the cables separate into your keyboard, mouse, network and printer connections. In between, they are combined into one slim run that reduces space requirements and complexity.

To achieve the benefits of frequency multiplexing, the feeder cable must be equipped with the correct combining devices. Two or more frequency bands can be combined using multiband combiners. Multiband

combiners (MBCs) are often added to a system as separate components, but they can also be built directly into other components such as antennas.

Widely known as crossband couplers, these combiners may be referred to as diplexers (two frequencies), triplexers (three frequencies), and so forth according to the number of frequency paths involved (Figures 4.2 and 4.3).

Multiband combining

A configuration that combines multiple frequency bands into a common RF path, such as combining multiple operators or technologies operating on different bands.

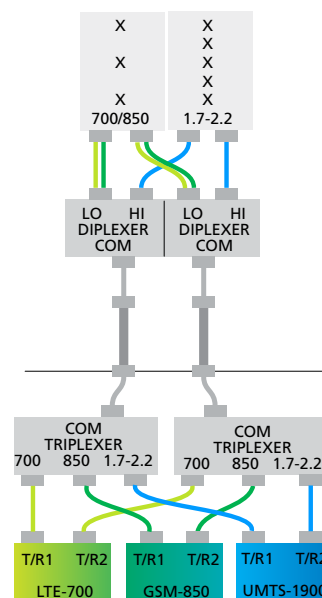
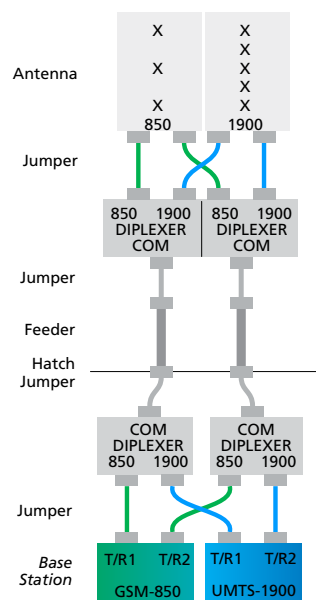

4.2: Shared feeders using diplex crossband couplers

4.3: Shared feeders using triplex crossband couplers, with broadband antennas using diplex crossband couplers

4 | Working within the limits: Co-siting solutions

The kind of MBC required in a particular application is largely determined by the frequencies the system uses, and, more specifically, how far apart from each other those frequencies are. In systems with wide frequency separation—such as 700-1000 MHz, 1700-2200 MHz and 2400-2700 MHz—the needed MBCs are likely to be low-cost, compact devices that introduce virtually no loss or mismatch.

However, when dealing with frequencies that are relatively close to one another—such as 700 MHz and 850 MHz—the appropriate MBC tends to become larger and more complex (Figure 4.4).

On the antenna side of the connection, additional efficiencies can be gained among broadband antennas that can accept more than one frequency through a single port. This allows it to operate over a range of bands through one feeder cable, as previously shown in Figure 4.3.

Like the other circumstances involved in planning an efficient and compliant base station site, antenna selection and the base station's assigned frequencies can play a large part in how a particular co-siting solution comes together.

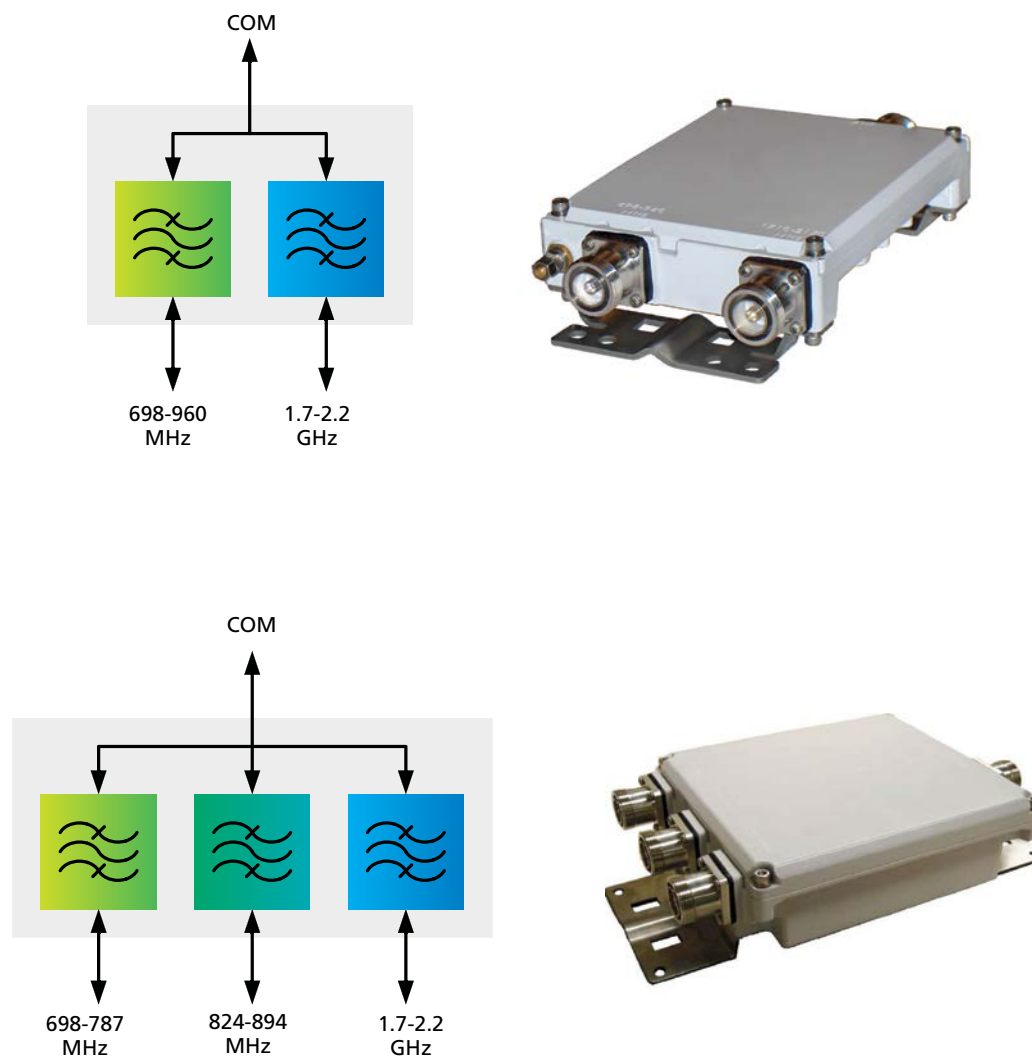

4.4: Compact duplex and triplex crossband couplers, with example frequency differentiation

Same-band combining

In some instances, multiple services require the use of the same frequency band. When this happens, multiband combiners—which are designed to suit specific frequency separation—don't provide the solution we need. Instead, we can use a variety of same-band combining (SBC) options, which can allow different services to share the same space on the electromagnetic spectrum.

In some applications, same-band combining is even used for single-service systems—not to allow other services, but to increase the channels available to the one operating service. In all cases, the idea is to combine transmit signals (TX) and divide receive signals (RX). The best way to achieve this depends on the specifics of the application.

Now let's look at some of the more commonly used techniques.

Hybrid combining

Hybrid combiners offer a low-cost means of combining TX signals and dividing RX signals (Figure 4.5), but this advantage comes at the cost of other operational restrictions inherent in its design.

The main disadvantage of this technique is the high rate of loss experienced in both directions. This

loss increases with the number of ports involved, so hybrid combiners are generally used only in two-port applications.

Another consideration is the significant heat it generates, which must be dissipated—adding costs and creating even more design limitations. These drawbacks limit the practicality of hybrid combining to in-building coverage and similar uses. It is rarely used in cellular sites.

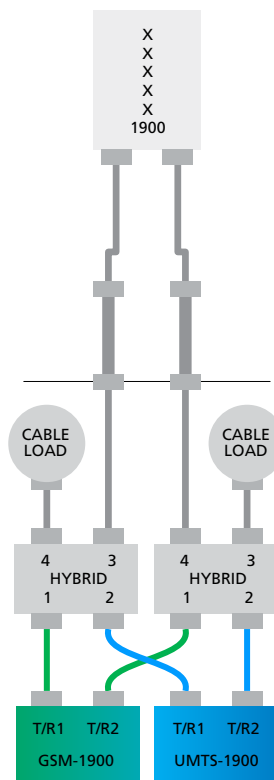

4.5: A hybrid combiner, using cable load to lower passive intermodulation

Same-band combining (SBC)

A configuration that combines multiple services, carried over same bands, into a common RF path. Such as combining multiple operators or technologies operating on the same bands.

4 | Working within the limits: Co-siting solutions

• Low loss combiner-multiplexers (LLCs)

LLCs offer a different way to combine base station transmitters. Integrated duplexers allow combining of TX signals and distribution of RX signals as well (Figure 4.6).

Like the multiband combiners discussed earlier, the LLC is a filter multiplexer. However, unlike an MBC that requires spaces between bands (recall that the bigger the spaces, the better the combiner operates), the LLC handles frequencies inside the same bandwidth. This is possible due to the addition of guard bands, which act as very small gaps within the band. They create boundary spaces between the frequencies, allowing them to be distinguished from one another.

Including these tiny guard bands often requires those narrow frequencies to be left unused, which adds up to slight bandwidth loss. In LLC design, smaller guard bands incur greater cost, size and complexity, so an economical alternative is to re-use the “lost” guard band space with a second feeder and antenna.

LLC design significantly reduces insertion loss over that of a hybrid combiner, but its reliance on filter multiplexing places significant restrictions on its scalability. As technology develops, networks require

constant upgrading, adjusting and scaling—which often entails replacement of the LLC component.

Several examples of LLC realizations are shown in Figures 4.7 and 4.8 on the following page.

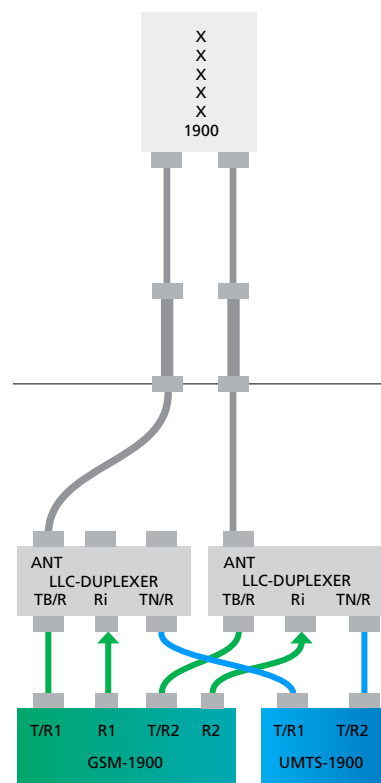

Guard bands

Narrow gaps kept between adjacent bands to minimize interference. Used by the low loss combiner (LLC) to distinguish between different signals riding on combined bands.

4.6: An LLC with integrated duplexer; RX distribution from GSM BTS

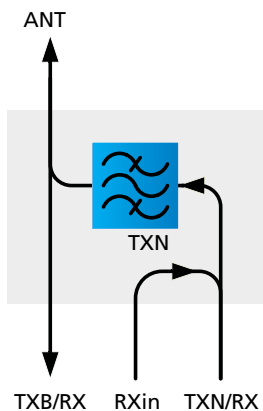

4.7: An LLC combines a narrow portion of TX band into broadband path; includes duplexer for RX re-injection

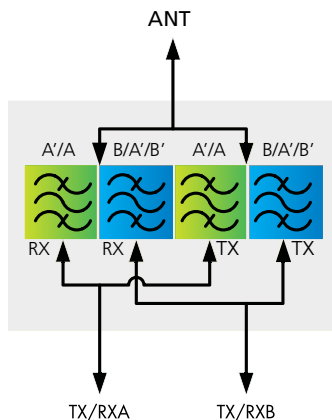

4.8: Filter multiplexer for downlink and uplink—a quadruplexer

Multiport antennas

Today's multiport antennas provide an excellent opportunity for mobile network operators (MNOs) to take advantage of antenna sharing while retaining control of their individual antenna elements and coverage patterns. Current modern multiport antennas are able to support ultra-wideband spectrum and multiple RET controllers, enabling sharing mobile operators to individually optimize their tilts electrically and expand their frequency band allocations, without physically modifying the antenna. An example is shown in Figure 4.9.



4.9: A multiport antenna panel

Sharing antennas—and co-siting antennas

A site's antennas are unique in that they are key considerations in both passive and active network sharing agreements. The variety of network sharing scenarios in which they are used has led to manufacturers engineering a high degree of versatility into the antenna's architecture.

Therefore, base station antennas have evolved to become highly complex and their proper use in network sharing arrangements can be complicated. Antenna sharing between multiple operators, for example, can be seen as so restrictive in terms of available degrees of optimization that it may seem more economical to simply add another, unshared antenna instead.

In fact, a regional market survey conducted by CommScope sales teams in August 2015 estimated the instances of antenna site sharing to be approximately 100 or fewer per operator in the Middle East and Africa, and virtually unheard of in North America and Europe. At the same time, co-siting individual antennas is a common practice in both North America and Europe, illustrating the economic issues driving the continued global rollout of 4G/LTE.

Sometimes, however, economy is not the only factor to consider. In some countries, such as Brazil, Canada, Jordan and Egypt, aesthetic, environmental, health or safety regulations force antenna sharing into play as a condition of the operators expanding their networks.

There are two basic solutions to antenna sharing: use of multiport antennas or deployment of combiners.

As illustrated in Figure 4.10, the biggest challenge when deploying multiport antennas in support of a shared network is the larger physical size of the antenna and the resulting increase in tower loading. This is especially problematic across multiport antennas in the lower frequency bands where the array is larger to begin with.

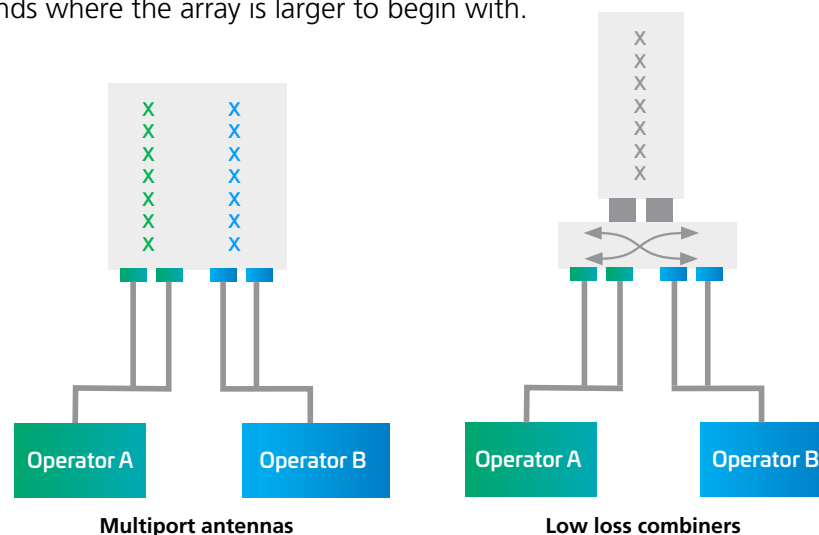

	Multiport antenna sharing	Combiner sharing
PROS	<ul style="list-style-type: none"> • Multi BTS RET control after mods • Normal PIM and VSWR risk • Lower RF path losses • Can re-allocate bands in future 	Normal antenna size and tower load for all bands
CONS	Increased antenna size and tower loading for low bands	<ul style="list-style-type: none"> • Higher PIM and VSWR risk • Increased RF path losses • Does not support multi BTS RET control • LLC fixed for existing bands

4.10: Multiport antennas and MBCs/SBCs allow for antenna sharing where it is required.

MNOs can also choose to deploy multiband or same-band combiners as an alternative to multiport antennas. This reduces the number of antenna arrays required and enables the operator to minimize the antenna size and tower loading. This type of solution is often used to deploy an LTE overlay onto a network's legacy services.

However, this approach also has drawbacks. Operators give up independent RET control and risk higher incidences of passive intermodulation (PIM) and VSWR. There are also greater RF path losses and, in order to add or change frequency bands, combiners may need to be replaced.

While either multiport antennas or combiners can be used to enable antenna sharing, the best solution may be a combination of both. Using a combiner for the low bands and a multiport antenna for the high bands takes advantage of the strengths of both technologies while minimizing the weaknesses. Certain antennas are available with factory-integrated combiners, reducing interconnections, allowing individual RET control and saving space on the tower but also offering less flexibility as to the bands that can be combined.

Antenna sharing capable antennas

So how can an operator ensure that it maintains control of its own traffic on a shared antenna? In most cases, multiport antennas will provide the required flexibility, RF performance and pattern control. However, to realize these benefits, the antenna must provide independent remote electrical tilt (RET) control for each operator—a capability not inherently available with all multiport antennas—so operators must either purchase new multiport antennas equipped with independent RET control or in some cases implement using external hardware.

RET uses an open platform developed by AISG. AISG's standards have led to improvements in RET control and monitoring, as well as reporting alarms and other important advances in remote management. Operators sharing antennas need to independently control their RETs through separate AISG inputs, as shown in Figure 4.11 (on the following page).

For non-sharing applications, antennas may be shipped with all RETs assigned to AISG input port 1, as shown in the diagram on the left of Figure 4.11. Through reconfiguration at the site, specific RETs can be assigned to AISG input port 2 to allow a second AISG controller to have independent control through this separate connection.

Remote electrical tilt (RET)

The capacity to remotely adjust the aim of an antenna's beam to optimize its efficiency. RET uses actuators built into the antenna to adjust the beam up or down relative to the horizon.

Antenna Interface Standards Group (AISG)

AISG is composed of representatives from the world's leading wireless equipment manufacturers and service providers, including CommScope.

4 | Working within the limits: Co-siting solutions

After an antenna sharing configuration has been completed, a specific RET can be controlled only through the AISG input port to which it is assigned. The diagrams shown in the middle and on the right show example configurations with the AISG input ports shaded the same color as the RETs that will be controlled.

To ensure equitable antenna sharing, the antenna's RET solution should work with the multiport antenna involved and offer independent control for each operator through their BTS management software. It should also be scalable to accommodate network growth and the addition of more antennas.

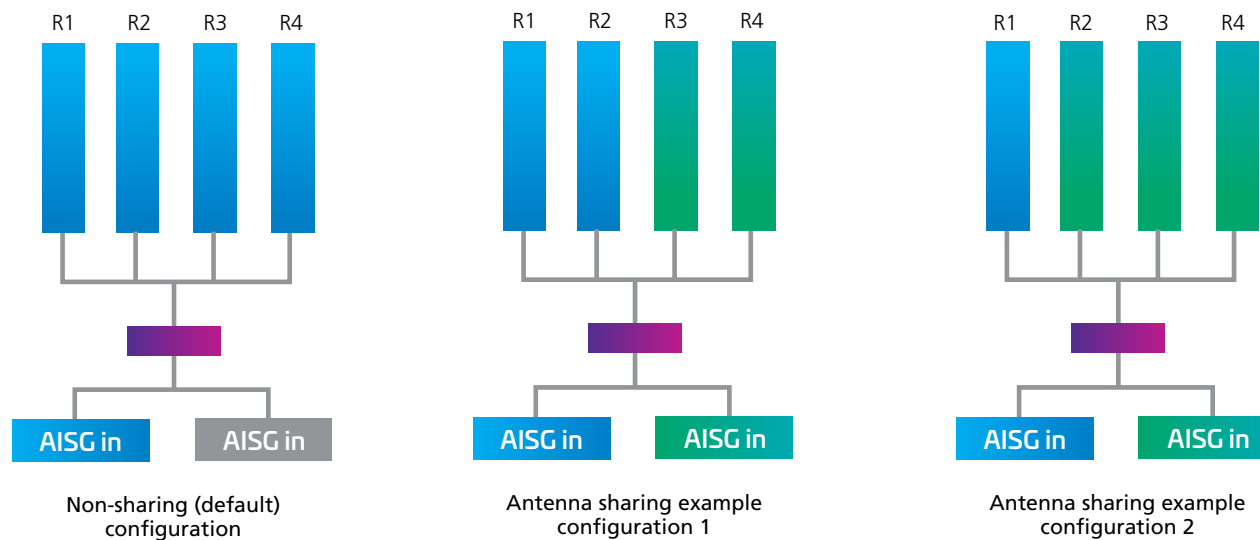

4.11: Various independent RET configurations

A closer look at active sharing

Active sharing is drawing a great deal of interest as a means of dealing with the high rollout costs of new and overlaid networks (such as 4G/LTE and 5G), as well as the constant need to conserve available spectrum. Operators are currently experimenting with several different active sharing arrangements involving various RF path components, spectrum assets and core network components.

Viewed as a continuum of complexity, one finds that there is a clear tradeoff involved between efficiency and flexibility. Here are three examples of arrangements, arranged in increasing degrees of sharing, summarized in Figure 4.12 (on the following page):

- **Multi-operator RAN (MORAN)**

Here, only the RAN components of the RF path are shared; specifically, the base transceiver station (BTS), base station controller (BSC), node B and radio network controller (RNC) are split into multiple virtual radio access networks, each connected to the core network of the respective operator. Operators continue to use their own dedicated frequency bands.

- **Multi-operator core network (MOCN)**

As with MORAN, RAN components are shared while core networks remain separate. The difference here is the addition of spectrum pooling to the mix. It allows each cell in the shared RAN to broadcast all sharing operators' identities and other relevant information, including their NMO (network mode of operation) and common T3212 (location update timer). Participating operators in this arrangement tend to be similar in terms of market presence and spectrum assets in order to create an equitable arrangement.

- **Gateway core network (GWCN)**

This goes even further, sharing infrastructure, frequencies AND core network elements, such as the mobile switching center (MSC), serving GPRS support node (SGSN) and—in some cases—the mobility management entity (MME). This configuration enables the operators to realize additional cost savings compared to the MOCN model. However, it is a little less flexible and regulators may be concerned that it reduces the level of differentiation between operators.

4 | Working within the limits: Co-siting solutions

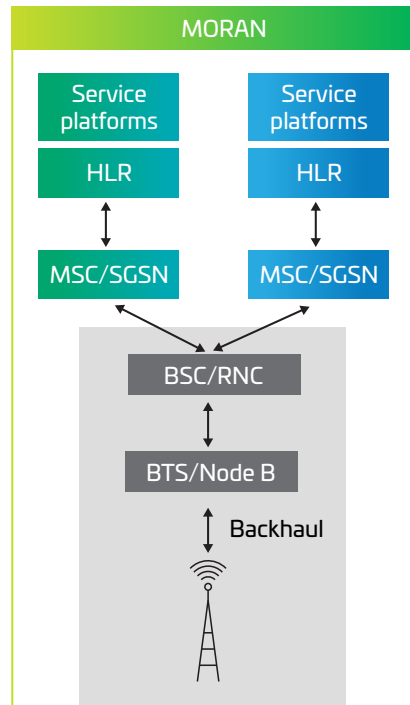

First stage of active RAN sharing where spectrum is not shared

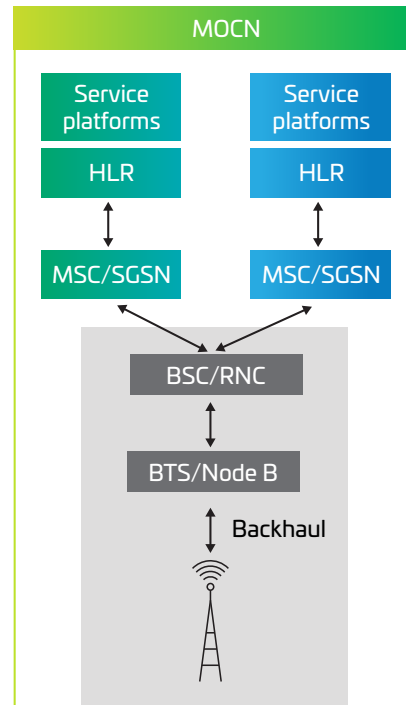

Second stage of active RAN sharing where spectrum is also shared

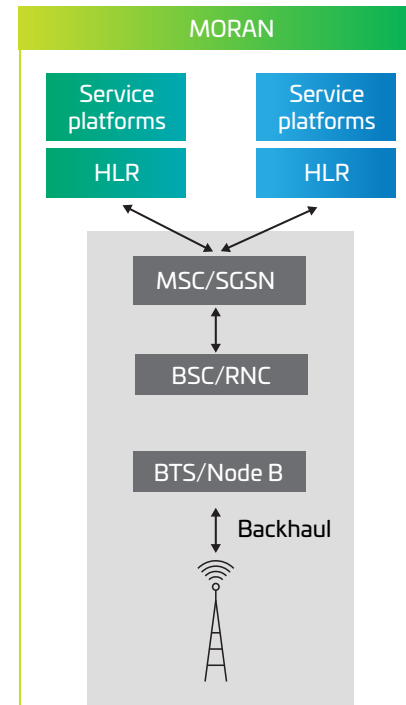

Third stage of active RAN sharing where CS and PS core elements are also shared

Key

- Operator A
- Operator B
- Shared element
- HLR = Home location register
- MSC = Mobile switching center
- SGSN = Serving GPRS support mode
- GPRS = General packet radio service
- BSC = Base station controller
- RNC = Radio network controller
- BTS = Base station

4.12: Active sharing models applicable to co-siting situations, showing increasing degrees of sharing

Making the most of available space and power

The design of a cellular communications system reflects many choices and compromises. The result is that no two deployments are exactly alike, and that every decision is based on a unique balance of benefit and cost.

Co-siting is an advantage to many and a necessity for some; as global demand rises and available spaces disappear, co-siting will become more common all over the world. With the right strategy and solutions, the opportunity can outweigh the costs, ensuring better service for users and better efficiency for operators.

Chapter 4 summary

- Network sharing includes passive and active sharing, national roaming and antenna sharing practices.
- Co-siting allows more performance in less space.
- Co-siting strategy is driven by amount, weight and cost of base equipment and antenna-mounted equipment
- Multiband combining leverages feeder cable's capacity for multiple frequencies—with guard bands.
- Same-band combining includes hybrid combining (inexpensive but lossy) and low-loss combiners (efficient but with limited frequencies).
- Independent RET control makes antenna sharing more practical.

Talking and listening at the same time: Transmission and receiving isolation systems



Chapter 5

Talking and listening at the same time: Transmission and receiving isolation systems

Right now, millions of people around the world are downloading music, streaming HD video, uploading photos to social media, texting, talking and listening on their mobile devices. It's probably safe to say they are not thinking about the science or technology that enables every download, text or conversation. Mobile devices are simply a way of life.

Here at CommScope, we're continually fascinated by the technical innovation and principles behind wireless communications and how to keep the lanes of information flowing freely in both directions. Take transmission and receiving isolation systems, for example. Unlike conventional landline phones, even the most sophisticated smartphone is really a radio receiver and transmitter, so maintaining seamless, simultaneous two-way communication—that is, talking and listening during a call, or streaming music while updating your social media status—is more complex than it appears.

An RF communications system that employs this simultaneous, two-way flow of voice, data or other information is called a “duplex” system. Duplex

communications systems combine multiple transmit and receive channels on a shared antenna, with information flowing both ways at the same time.

Imagine the simultaneous flow of traffic on a busy two-way street. You can immediately see the importance of keeping the two different directions of traffic separated. Just as vehicles on a busy, two-way street require clear lane markings to avoid collisions with oncoming vehicles, duplex RF channels also must be “isolated” from each other to avoid interference.

In RF terms, isolation is measured as the loss between two channel ports—either transmitter-to-transmitter or transmitter-to-receiver ports. The higher the loss, or isolation, between the two ports, the cleaner the signal.

Duplex communications

A transmitter and receiver that work at the same time on the same RF device.

Isolation

The amount of separation achieved between the transmitter and receiver in a duplex communication system. In general, more isolation translates to less interference and clearer communications.



5 | Talking and listening at the same time: Transmission and receiving isolation systems

To allow this two-way communication to flow on a single antenna, a duplexer must be used with adequate isolation measures (Figure 5.1). Measured in decibels, isolation is a critical consideration in the design of any duplex system. Without proper isolation, a transmitter will adversely affect the performance of its associated receiver even though they may operate on different frequencies.

The specifications covering a particular receiver, for instance, may indicate that any RF signal outside the receiver's passband (which can be as narrow as 15 kHz) will be attenuated, or weakened, by as much as 100 dB. That means the transmission's power will be reduced to

1/10,000,000,000th of its original strength—making the communication unintelligible and useless in most cases.

You might think such a selective receiver would prevent interference from a transmitter operating on a frequency far outside the receiver's passband. After all, if the interfering signal is 5 MHz away, how could it create complications when being just 5 kHz off the mark reduces the transmitter's signal to virtually nothing? The answer lies in the characteristics of modern receivers and the way they can step high-frequency signals downward to achieve such precise frequency selectivity.

Duplexer

A device situated between a duplexed antenna and its associated transmitter and receiver. A duplexer's function is to provide isolation between the signals.

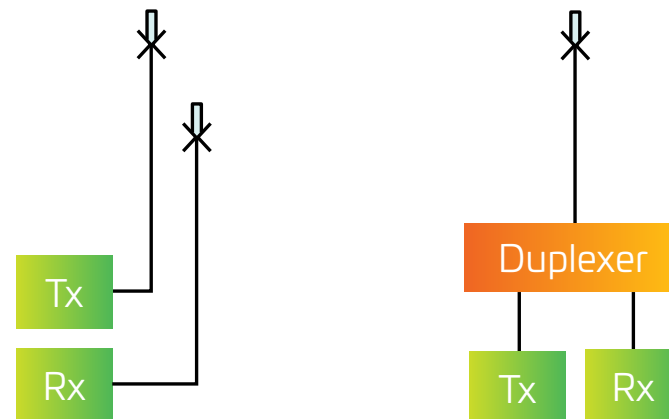

5.1: Two solutions: Use two antennas, or a single antenna with a duplexer

The first challenge: receiver desensitization

Receiver desensitization is an inherent side effect of modern receiver design, which receives relatively high-frequency signals (often between 700 MHz and 3500 MHz). These signals pass through frequency-lowering stages in the receivers, which allow the receivers to feature such narrow, selective passbands (Figure 5.2). Once the signal has been lowered enough, only a small band remains and the circuitry can reject other bands within a margin measured in decibels. A receiver's specification sheet will include this measurement of overall selectivity.

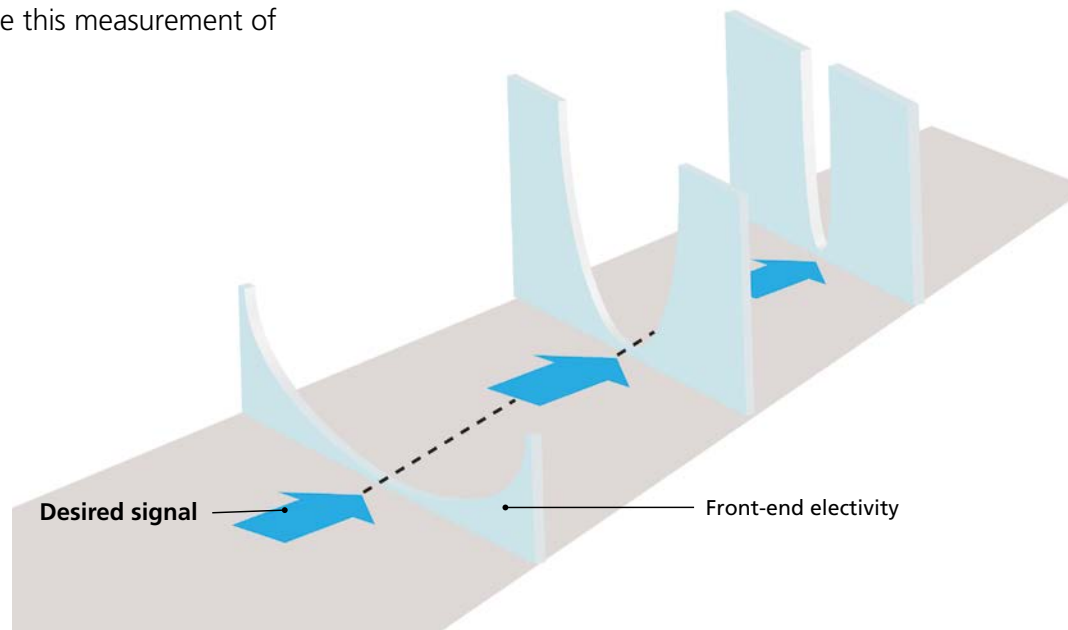

5.2: In a receiver, high-frequency signals are reduced in stages

Receiver desensitization

Interference caused by unwanted frequencies entering a receiver's upper-stage passbands. These errant signals create electrical variances that impede the receiver's operation.

5 | Talking and listening at the same time: Transmission and receiving isolation systems

For optimum performance, critical voltage and current levels exist at certain points throughout the front-end stages of a receiver. If these levels change significantly, the performance of the receiver suffers. This happens when a nearby transmitter's off-frequency signal enters the front-end stage.

Such signals can be several megahertz away from a receiving frequency, and radiate from sources several thousand feet away, and still cause significant interference (Figure 5.3).

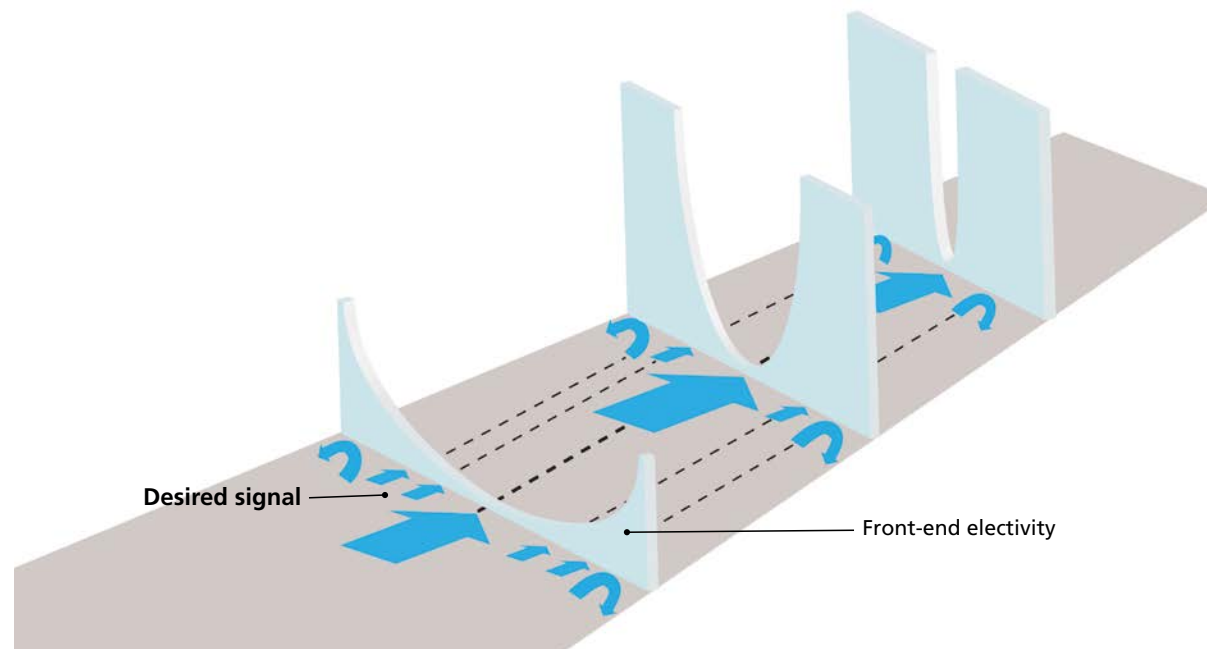

5.3: Unwanted frequencies (shown here as reflected arrows) can alter critical receiver voltage and current levels

5 | Talking and listening at the same time: Transmission and receiving isolation systems

The second challenge: transmitter noise

Transmitter noise is interference caused by carrier signals just outside of a transmitter's assigned frequency. In an ideal world, a transmitter would channel 100 percent of its signal power into the narrow band of frequencies assigned to its transmission channel. In the real world, however, this level of precision is simply not possible, and the result is called "transmitter broadband noise radiation"—or, more commonly, "transmitter noise." While the vast majority of transmission power remains within the assigned channel, there remains a small fraction that "leaks" into channels above and below the intended carrier frequency.

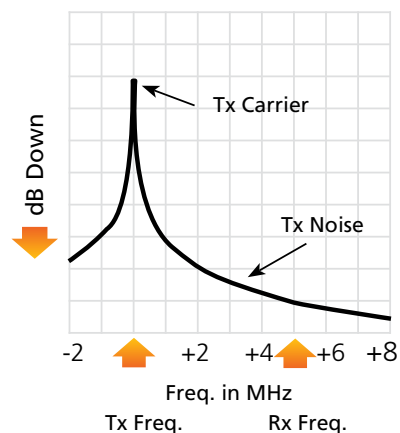

5.4: Transmitter interference is most pronounced near the assigned frequency (shown here as Tx frequency, located at zero on horizontal axis)

Modern transmitters are equipped with filter circuits that eliminate a large portion of these errant signals; but, even with these measures in place, enough transmitter noise can escape to degrade the performance of a receiver. As the chart below illustrates, this interference effect is most pronounced at frequencies closest to the transmitter's carrier frequency (Figure 5.4) but can also impact receivers operating several megahertz away.

We hear transmitter noise in a receiver as "on-channel" noise interference. Because it falls within the receiver's operating frequency, it competes with the desired signal and cannot be filtered out.

To illustrate this kind of interference, imagine having a conversation with someone in a crowded room. If everyone else is talking, you'll notice how hard it is to understand the other person—even if the overall noise level in the room is relatively low. That's because other voices—like unwanted transmitter noise—are similar to the voice you're trying to hear.

This is a key distinction between transmitter noise and receiver desensitization, which, you'll recall, comes from signals far from the operating frequency of the receiver. In the context of our conversation-in-a-crowded-room metaphor, receiver desensitization is more like loud, disruptive sounds coming from a construction site next door. The interference is not similar to the voice you're trying to hear, but it still distracts you from the other person's voice.

Transmitter noise

Interference experienced by a receiver as a result of transmission power "leaking" into other nearby frequencies.

How isolation helps duplex communications overcome both challenges

In duplex RF systems, transmitting and receiving frequencies are close to each other. In addition, the antennas will also be physically close or even share a single multipoint antenna. Now that we understand the source and nature of the two interfering elements—receiver desensitization and transmitter noise—how can we overcome these interfering influences and assure reliable operation of our paired transmitters and receivers?

The answer, as you may have guessed, is proper isolation.

Earlier in this chapter, we explored how a duplex RF system requires isolation between transmitter and receiver. But, when applying that concept to practical application, adding isolation to the system requires some planning and a bit of math. Remember that we have not one but two sources of interference to overcome—receiver desensitization and transmitter noise—and each requires its own solution.

It boils down to two simple questions:

1. How much isolation is required to **prevent receiver desensitization** from the transmitter's carrier, and;
2. How much isolation is required to **reduce transmitter noise** to a lower, even negligible level?

While these are simple questions, each has many more questions built into it—such as, but not limited to:

- How close together are the transmitter and receiver frequencies?
- What frequency band are we using?
- What is the transmitter's power output?
- What are the unique product specifications for the particular transmitter and receiver we're using?

While each application will have very different answers for these and other considerations, you can usually find the answers in the equipment manufacturer's data. For the purposes of this discussion, we'll focus instead on the broader use of isolation in duplex systems.

5 | Talking and listening at the same time: Transmission and receiving isolation systems

Determining the amount of required isolation is a matter of examining both sources of interference and identifying the optimal isolation level. As shown below (Figure 5.5), we see the effect of frequency on both interfering influences: receiver desensitization (dotted line) and transmitter noise (solid line).

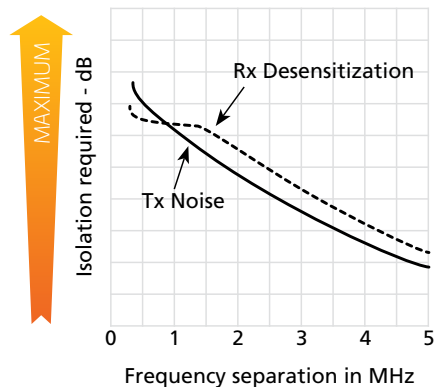

5.5: The effect of frequency separation on receiver desensitization and transmitter noise

In short, the closer the frequencies are to one another, the greater the need for isolation. For instance, the chart shows that reducing the frequency separation from 5 MHz to 1 MHz requires double the isolation to assure that the receiver will not be sensitized, and that transmitter noise will be reduced to negligible levels.

Achieving sufficient isolation

Once we have determined the requisite amount of isolation by answering our specification questions and applying what we learned from Figure 5.5, we can implement the correct degree of isolation by one of two methods:

1. Use two antennas, physically separated by a given distance, or;
2. Use the appropriate duplexer with a single-antenna system.

Let's examine the first option of two physically separated antennas. Within this option, there are two ways of achieving the desired result: horizontal and vertical separation.

Horizontal separation

The practice of placing a transmitter's antenna a certain distance from the same device's receiving antenna to achieve the necessary isolation.

Method 1: Two antennas—horizontal separation

If you've ever driven cross-country with the car radio on and heard a favorite song fade to static, you've experienced an effect called "propagation loss." Propagation loss describes the way an RF signal loses intensity and weakens (or attenuates) as it travels across distance. This effect means that placing the two antennas apart—creating horizontal separation—yields a certain amount of isolation simply by virtue of signal attenuation in the space between them (Figure 5.6).

With enough distance, we can achieve virtually perfect isolation and total protection from both receiver desensitization and transmitter noise. However, even the most isolated RF system is vulnerable to interference from outside sources located nearby.

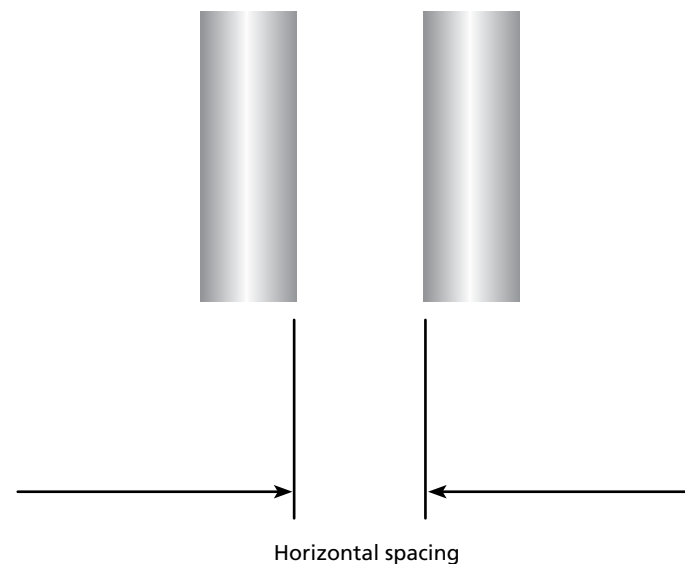

5.6: Horizontal antenna spacing and isolation

5 | Talking and listening at the same time: Transmission and receiving isolation systems

Method 1 alternative: Two antennas— vertical separation

Alternately, one may achieve the same isolating effect by separating the transmitter and receiver vertically, a practice called “vertical separation.” In real-world applications, this option is more convenient and efficient as it allows both transmitter and receiver to be mounted on a single tower, one above the other, separated by the requisite distance to achieve sufficient isolation.

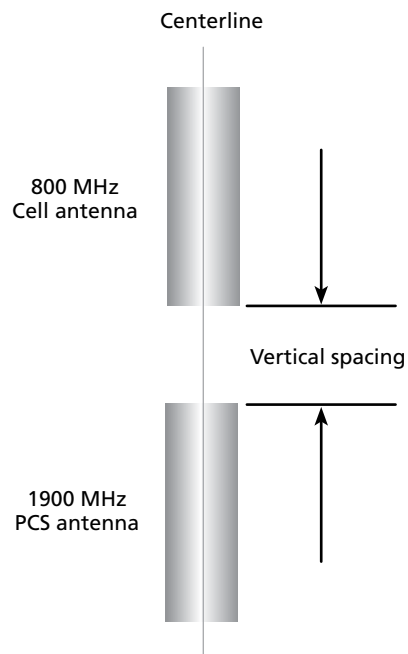

5.7A: Vertical antenna separation and isolation

A secondary benefit of vertical separation is that this arrangement takes advantage of what is known as the “cone of silence” that exists between vertically stacked antennas (Figures 5.7A and 5.7B).

The cone of silence is a dead zone (technically known as a “null” or “lack of gain”) that extends above and below communications antennas, allowing each to operate in the other’s shadow, so to speak.

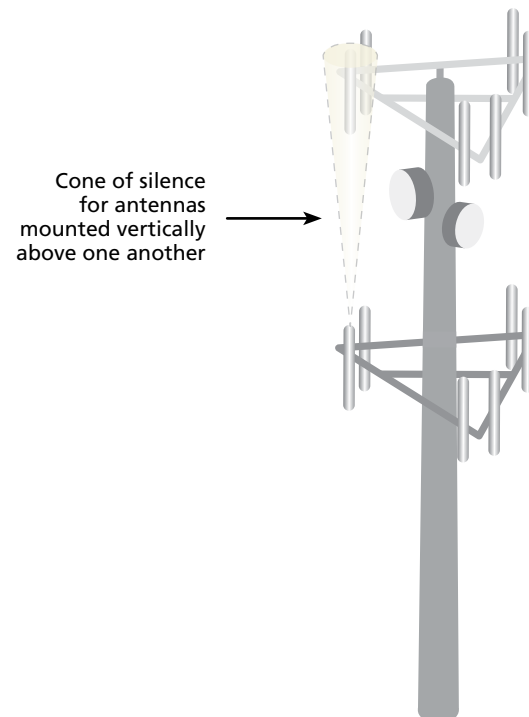

5.7B: The “cone of silence” isolates antennas directly above and below each other

Vertical separation

The practice of placing a transmitter and receiver in separate locations on a single antenna, allowing the height difference to achieve the necessary isolation.

5 | Talking and listening at the same time: Transmission and receiving isolation systems

It should also be noted, however, that the effects of horizontal and vertical separation are not directly additive—in other words, using both methods on the same system will not yield the full, combined isolation of each. Antenna manufacturers can supply specific figures on what you can expect from combining methods in any particular application.

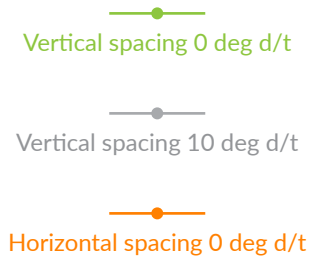

5.7C: Graphs at right describing attenuation (in dB) against separation (in feet) for both horizontally and vertically separated antenna pairs

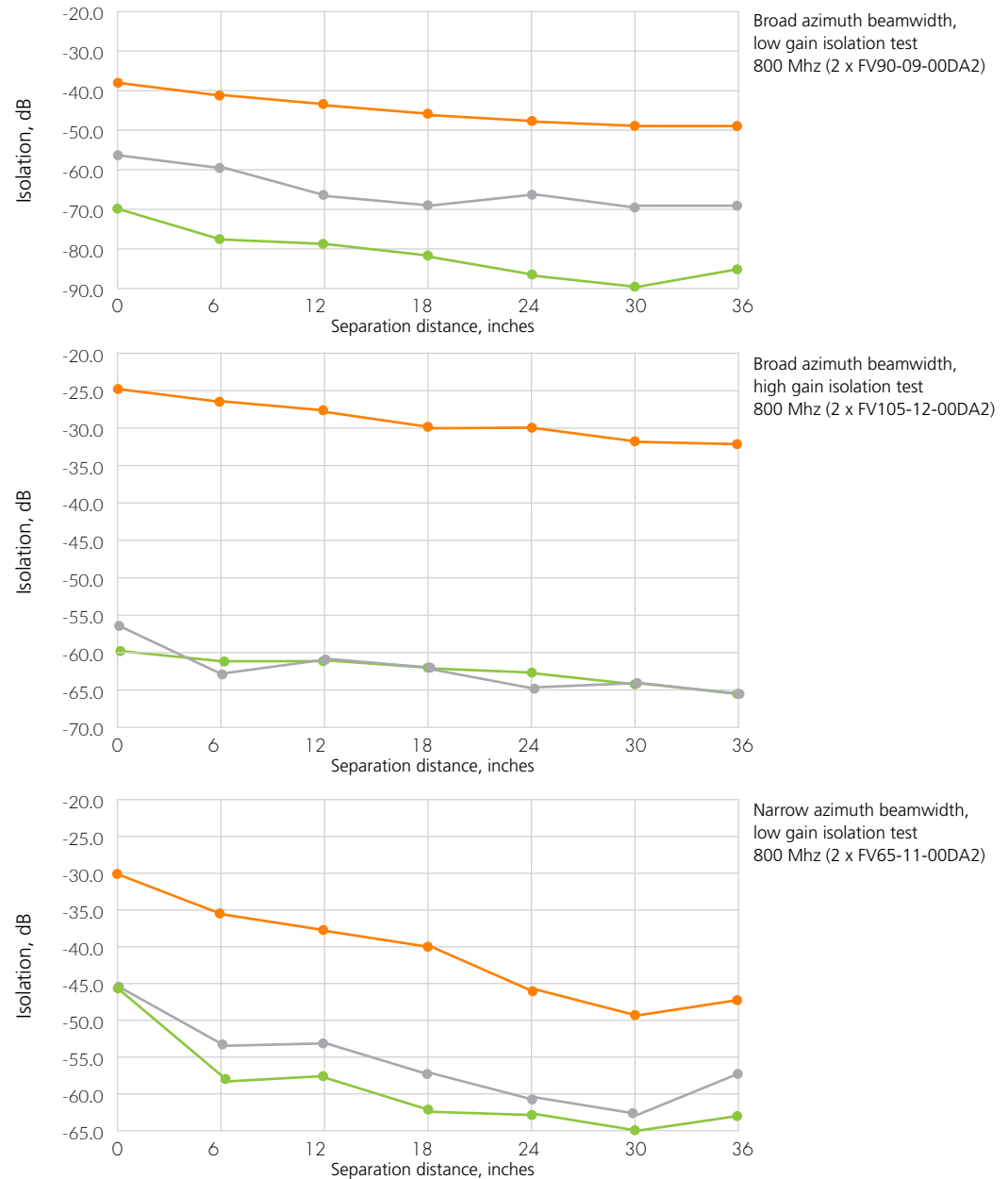

5 | Talking and listening at the same time: Transmission and receiving isolation systems

Method 2: One antenna with a duplexer

The other method of achieving the required isolation between transmitter and receiver is the use of a duplexer in a single-antenna system. A duplexer replaces one of the two antennas and two lengths of coaxial cable by allowing both transmitter and receiver to operate at the same time, on the same antenna (Figure 5.8).

The cost benefits from this option can be significant, as a duplexer cuts the needed infrastructure in half. But even these significant cost benefits are secondary to the other advantages, including:

- **Isolation.** A duplexer reliably isolates transmitter and receiver regardless of variable external circumstances or surrounding terrain.
- **Antenna pattern.** Without a duplexer, two separated antennas are required. Whether arranged in a horizontally or vertically separated configuration, they cannot occupy the same space. This separation means the coverage area of either the transmitter or receiver may be larger or smaller than the other.
- **Tower space.** Leasing tower space is expensive—and getting more so by the day. By using duplexers and building or leasing space on only one tower instead of two, operators can realize lower total cost of ownership.

These are all good reasons to opt for a single antenna with a duplexer; but, as with every advantage in engineering, there are drawbacks as well. We'll explore these considerations shortly, but, for now, let's examine how a duplexer actually works and how to choose the right one for a particular application.

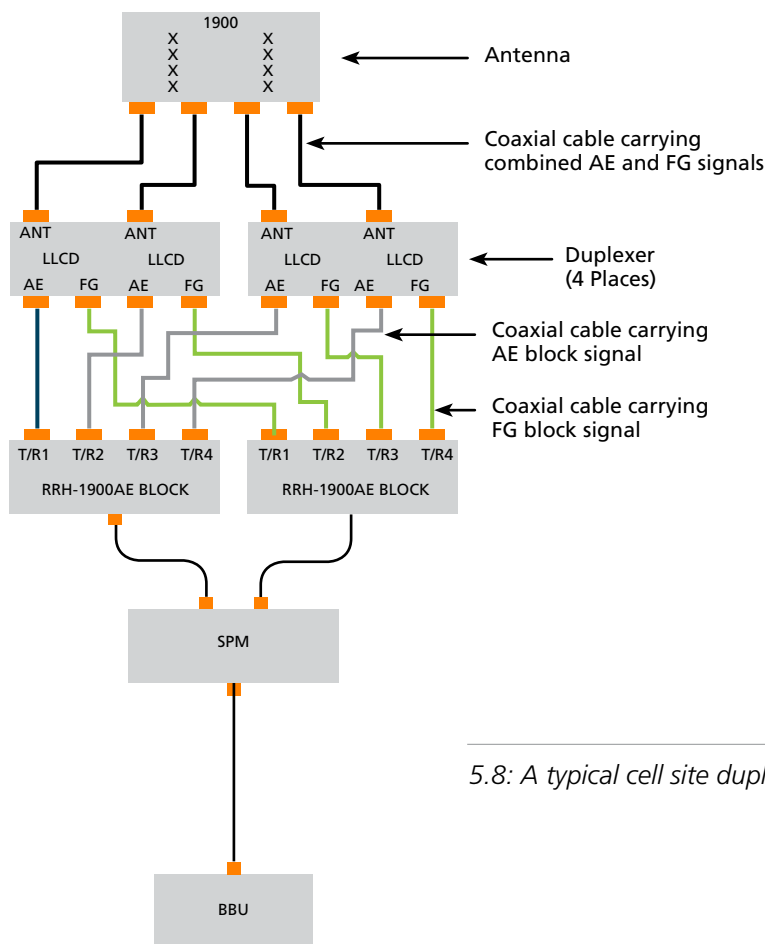

5.8: A typical cell site duplexer configuration

5 | Talking and listening at the same time: Transmission and receiving isolation systems

Considerations in choosing a duplexer

There are two distinct families of duplexers used in two-way RF communications: the bandpass duplexer and the band-reject duplexer. To choose the right option, it's important to consider the requirements of the system and what the correct duplexer must do. For the best results, a duplexer must:

1. Be designed to operate in the system's frequency band
2. Be able to handle the transmitter's power output
3. Operate at or below the system's frequency separation
4. Create minimal power loss to transmit and receive signals
5. Provide at least a minimum level of transmitter noise rejection
6. Deliver sufficient isolation to prevent receiver desensitization

These last two factors relate specifically to isolation and prevention of interference. In both cases, protection must meet a minimum threshold, but there is no hard upper limit—and no harm in exceeding specified isolation levels.

Losses through the duplexer

As a matter of course, the signal strength of both the transmitter and the receiver are reduced slightly in the process of passing through the duplexer. These losses are called "insertion loss: transmitter to antenna" and "insertion loss: receiver to antenna."

Like losses caused by other forms of attenuation, these duplexer losses are measured in decibels and tend to increase as frequency separation between transmitter and receiver decreases (Figure 5.9).

Insertion loss: transmitter to antenna	
Insertion loss	Reduced power (watts)
0.5 dB	11%
1.0 dB	20%
2.0 dB	37%

Insertion loss: receiver to antenna	
Insertion loss	Reduced strength (microvolts)
0.5 dB	5%
1.0 dB	11%
2.0 dB	20%

5.9: Equivalent signal power loss at discrete duplexer insertion loss levels

5 | Talking and listening at the same time: Transmission and receiving isolation systems

The bandpass cavity

The distinguishing feature of the bandpass duplexer's design is the bandpass cavity. The bandpass cavity works as a filter of RF frequencies, allowing a narrow band of desired frequencies to reach the receiver and attenuating frequencies outside this band. Energy is fed into the cavity by means of a coupling loop. This energizes the resonant circuit formed by the inner and

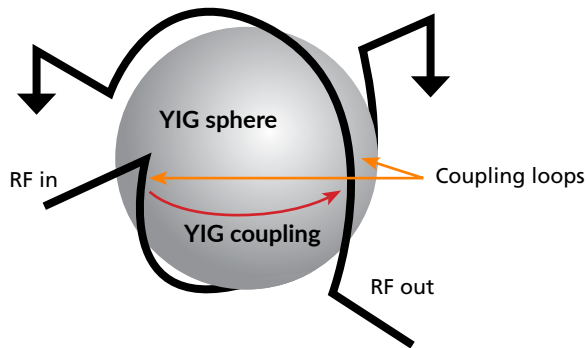

5.10: The operation of a coupling loop

outer conductors. A second loop couples energy from the resonant circuit to the output (Figure 5.10). The loops determine the selectivity of the bandpass cavity.

The narrow band of desired frequencies that pass through the cavity experience only slight loss and are all within a few thousand cycles of the cavity's resonant frequency. The effect of multiple frequencies, transmitted at equal power, on a bandpass cavity is illustrated below (Figure 5.11).

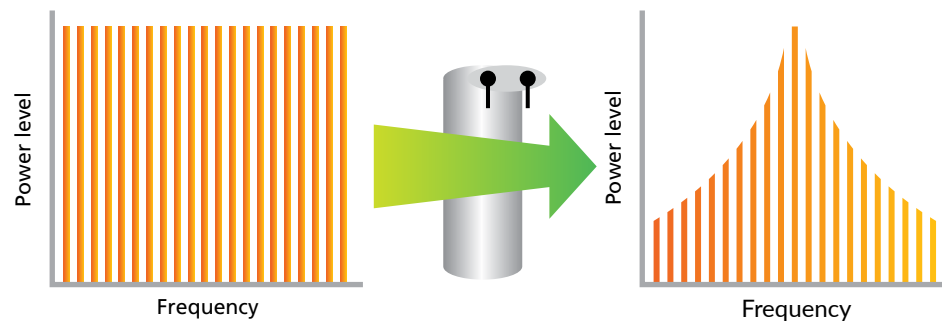

5.11: Attenuation of undesired frequencies passing through a bandpass duplexer

Bandpass cavity

A "frequency filter" that limits the channels that pass through the filter to a select set of frequencies. Other frequencies are prevented from passing. Most devices have multi-stage bandpass cavities that filter out different frequencies at each stage.

Resonant frequency

The natural tendency of a system to oscillate with larger amplitude at particular frequencies. At these frequencies, even small periodic driving forces can produce large amplitude oscillations.

5 | Talking and listening at the same time: Transmission and receiving isolation systems

The selectivity of a bandpass cavity is usually illustrated in a frequency response curve. This curve describes the degree of attenuation provided by the cavity at discrete frequencies above and below the cavity's resonant frequency. The curve also shows the insertion loss to the desired signal at the cavity's resonant frequency (Figure 5.12).

In cases where a single bandpass cavity cannot provide enough rejection to undesired frequencies, the addition of more cavities in sequence can further refine selectivity. While this results in additional insertion loss, selectivity can be increased substantially.

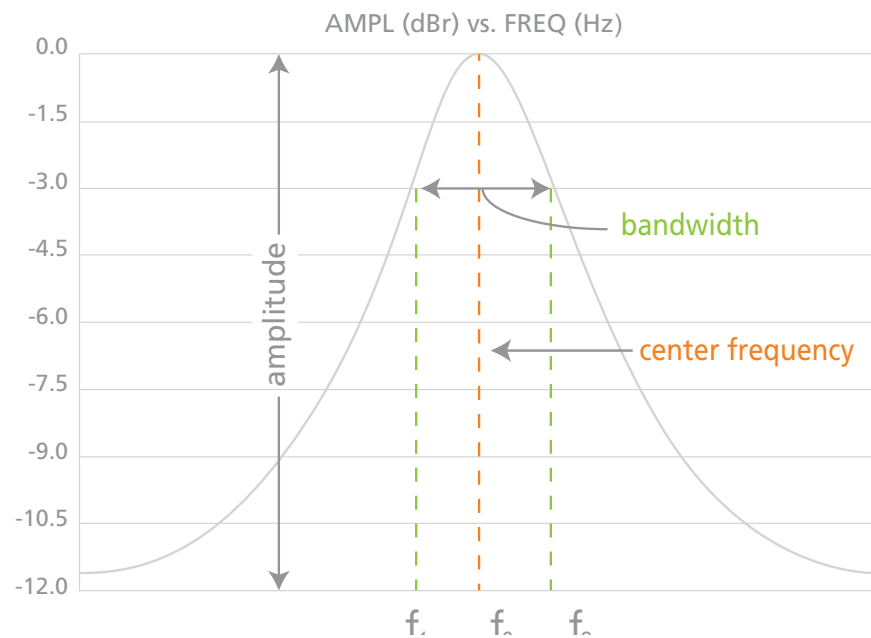

5.12: The effect of bandpass filter on multiple frequencies

5 | Talking and listening at the same time: Transmission and receiving isolation systems

The bandpass duplexer

It is the combination of two or more of these bandpass cavities—interconnected in a duplex configuration—that makes a bandpass duplexer work. One or more of the cavities are placed in the transmitter part of the duplexer, tuned to allow only the narrow band of transmitting frequencies to pass freely. Similarly, those cavities in the receiving part of the duplexer are tuned to the narrow band of receiving frequencies (Figure 5.13).

The transmitter's output signal is filtered through the transmitter bandpass cavities of the duplexer on its way to the antenna, with the desired frequencies experiencing very little loss. At the same time, undesired frequencies are attenuated significantly, reducing the transmitter noise that could otherwise interfere with the signal. As an added bonus, this reduced transmitter noise not only improves the signal to our own receivers, but those operating on different frequencies as well. By limiting errant frequencies, we reduce the likelihood of receiver desensitization for other users on entirely different channels.

Similarly, the bandpass cavities on the receiver part of the duplexer (again, usually two or more cavities in a duplex configuration) are resonant to receive only assigned frequencies. As with the transmitter's bandpass

cavities, there is a modest loss of power in the process of receiving, but unwanted frequencies are attenuated to negligible levels.

The net effect is that off-frequency signals are virtually invisible to the receiver, protecting it from desensitization—not only from its own corresponding transmitter, but from others operating on completely different frequencies.

Bandpass duplexer

A duplexer that uses multiple bandpass cavities to separate transmitter and receiver signals, allowing for simultaneous two-way communications.

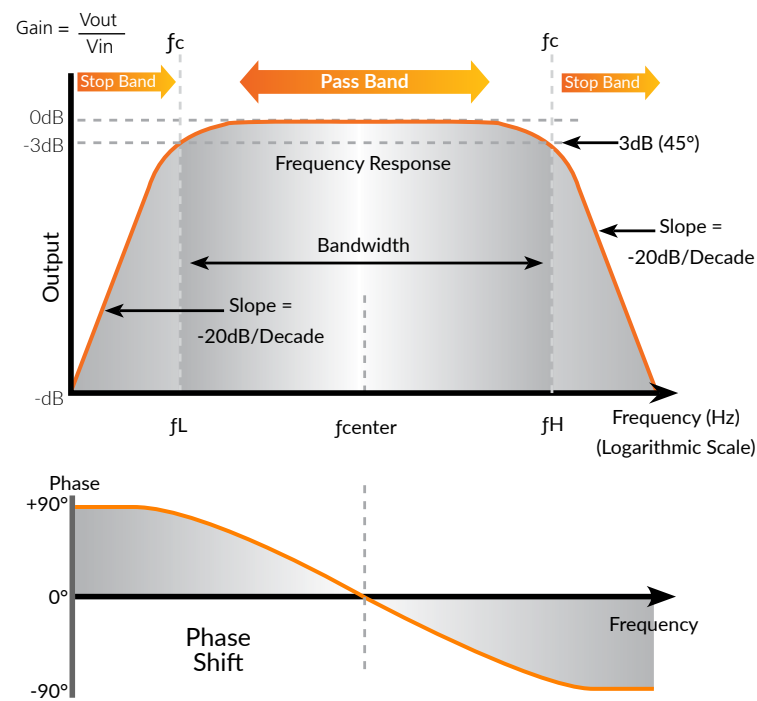

5.13: The effect of bandpass filter on multiple frequencies

5 | Talking and listening at the same time: Transmission and receiving isolation systems

Similarly, the bandpass cavities on the receiver part of the duplexer (again, usually two or more cavities in a duplex configuration) are resonant to receive only assigned frequencies. As with the transmitter's bandpass cavities, there is a modest loss of power in the process of receiving, but unwanted frequencies are attenuated to negligible levels.

The net effect is that off-frequency signals are virtually invisible to the receiver, protecting it from desensitization—not only from its own corresponding transmitter, but from others operating on completely different frequencies.

Isolating the best solution

Modern two-way RF communications networks must contend with the interfering effects of both receiver desensitization and transmitter noise. While a two-antenna solution is one way to address these factors, most practical applications must contend with space, cost and antenna availability limits. In most cases, a bandpass duplexer provides the requisite isolation between transmitter and receiver—even when operating on the same antenna.

With the isolating properties afforded by a bandpass duplexer, both transmitter and receiver can operate efficiently while reducing transmitter noise and receiver desensitization. The result is a compact, efficient and reliable communications network that easily accommodates two-way communication of voice and data.

Behind every simple call or text on millions of mobile devices at any given moment is a world of complex science and technology at work—and now you have a better understanding of the important role transmission and receiving isolation systems play in RF communications.

Chapter 5 summary

Duplex RF communications:

- Allow simultaneous two-way signal traffic
- Inherently vulnerable to interference and require isolation to work efficiently

Sources of interference:

- Receiver desensitization
- Transmitter noise

Isolation:

- Techniques that prevent both kinds of interference
- Measured in decibels; the higher the decibel loss, or attenuation, the clearer the signal

Antenna solutions:

- Polarization separation
- Horizontal separation
- Vertical separation
- Addition of duplexer

Duplexer choices:

- Bandpass duplexer
- Band-reject duplexer

Getting from the air to the network: Cables and connectivity



Chapter 6

Look around your home and office and you'll see wires, cords and cables everywhere. In your office, network cables connect your computer to the outside world. In your living room, coaxial cables bring in premium programming—and high-definition video cables feed it to your flat-screen TV. Even homes that have replaced land lines with mobile phones rely on coaxial cable or fiber optics within the network to carry the signal to their phones. These connections manage the flow of information that drives our daily lives. CommScope is dedicated to the continuous improvement of cable technologies that have an impact on every life, every day.

Whatever its composition or size, every cable performs the same simple functions: the reliable transmission of power or patterns of information (or both!) from a transmitter to a receiver.

This cabling infrastructure—also known as “transmission line”—is what connects the vast universe of cellular communications from the airwaves to the central office that connects your call, making them an indispensable part of the RF path.

Much more than power alone

Long ago, transmission lines were used primarily to provide electrical connectivity. Multi-conductor transmission lines could efficiently connect a power source (like a generator or battery) to a device that would consume that energy. This kind of simple circuit configuration is common even today; you create such a connection every time you plug an electrical device into a wall socket.

As telephone technology emerged, the limitations of this technique soon became apparent. When passing multiple circuits along a single transmission line, the signals proved highly vulnerable to external interference that negatively affected call clarity.

Transmission line

In RF applications, the physical medium that conducts RF power from one point to another, usually between a base station and an antenna.

To address this problem, Bell Telephone Laboratories developed a new type of cable in the 1930s. It was a shielded cable consisting of an inner wire surrounded by non-conductive material called a “dielectric.” This nonconductive material was then surrounded by an outer, sleeve-shaped conductor, and the whole assembly was finally encased in an insulating cover. This design may sound familiar to you, since it represents the first coaxial cable, which is little changed even today for data transmission (Figure 6.1).

In RF applications, coaxial cable is used as a transmission line for radio frequencies that penetrate only the outer layer of a solid conductor—a transfer known as the “skin effect.” The benefit of this arrangement is that it allows the outer surface of the outer conductor to be grounded.

Signals pass along a coaxial cable by riding the outer surface of the interior conductor—and the inner surface of the outer conductor—with a nonconductive dielectric layer between them. As a result, the only escape points for the energy carried on the line are at either end—exactly where they’re needed for clear transmission.

Coaxial cable

A transmission line built to prevent interference while carrying multiple signals. It consists of an inner core conductor and an outer sleeve conductor, separated by a nonconductive dielectric layer.

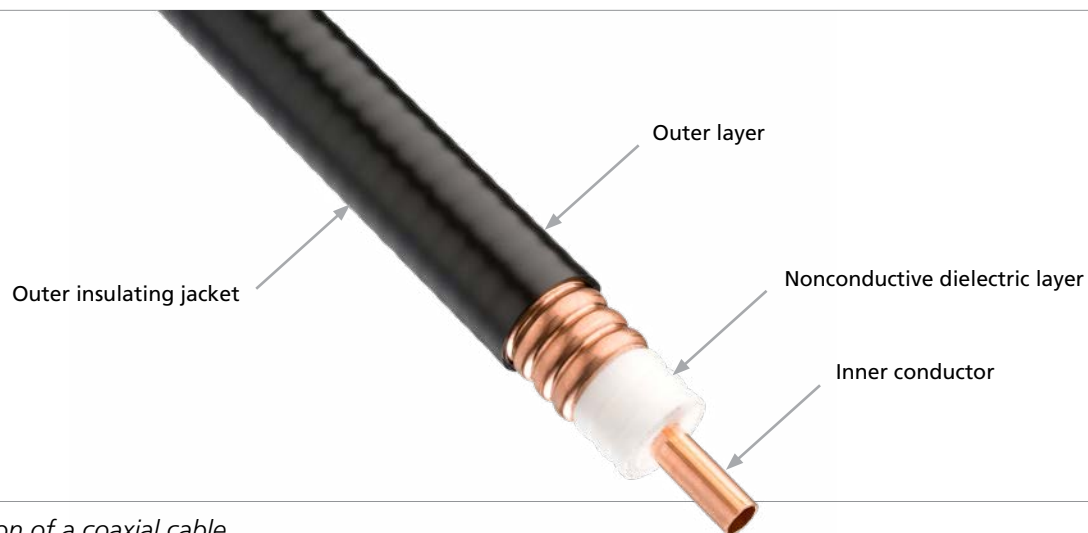

6.1: The basic construction of a coaxial cable

Coaxial cable types

Modern coaxial cables used in RF transmission can be grouped into three main categories: solid dielectric, air dielectric and foam dielectric. The construction of each category makes each of them suited to particular uses.

CABLE TYPE	ADVANTAGES	DISADVANTAGES
<p>Solid dielectric cables employ a flexible inner conductor (stranded or woven, as opposed to a solid wire), covered by solid extruded polyethylene insulation. The outer conductor is braided, and multiple layers can be stacked with shielding foil between them. The outer insulation is a polyethylene jacket.</p>	<ul style="list-style-type: none"> • Flexible • Easy to install • Inexpensive • No pressurization required 	<ul style="list-style-type: none"> • High signal loss • Prone to deterioration • RF signal leakage through outer conductor
<p>Air dielectric cables are similar to the solid variety except that they employ open space as the inner nonconductive layer. This cavity is supported with small insulating spacers that maintain the open channel and are pressurized to keep out moisture.</p>	<ul style="list-style-type: none"> • Low signal loss • High power and frequency capacity • Long operational life 	<ul style="list-style-type: none"> • High initial costs • Pressurization logistics • Vulnerability to moisture
<p>Foam dielectric cables employ a solid, as opposed to stranded, copper wire core. The outer conductor is generally smooth aluminum, corrugated aluminum or corrugated copper. The inner nonconductive layer is made of polymer foam, which combines several key advantages from both solid and air dielectric cable varieties. Its power loss and cost characteristics lay between the two other options, but foam also offers practical advantages that make it the preferred choice in many modern two-way RF applications.</p>	<ul style="list-style-type: none"> • Reduced power loss • No pressurization required • Moderately priced • Long operational life • Enhanced crush resistance 	<ul style="list-style-type: none"> • Slightly more loss than air dielectric • More expensive than solid dielectric

The mechanical elements of coaxial cable

Several material choices are available for both the conductive and nonconductive elements of coaxial cable. The specific needs of a particular use determine which combination is most efficient and affordable. Figure 6.2 shows one of the many variants available.

Signal energy is carried along the inner and outer conductor. You will notice that, in both cases, the surface area of the outer conductor is much greater than that of the inner conductor. Therefore, the conductive properties of the inner conductor must be as efficient as possible. That's why highly conductive copper is almost universally preferred.

Braided copper is the most commonly used outer conductor on solid dielectric cables. Copper is again chosen for its exceptional conductivity, and it is used in a braided form to improve its flexibility. Solid copper or aluminum material, either corrugated or smooth-walled, is most often used for foam or air dielectric cables. The choice between aluminum and copper often comes down to cost—while aluminum is less expensive than copper, it also has lower conductivity.

In RF transmission lines, the preferred dielectric material is polyethylene due to its low loss characteristics and long life span. This material can be used in either solid or foam dielectric constructions, or as the spacers in an

air dielectric design. For high-power applications with higher operational temperatures, Teflon® is substituted because of its high melting point. Teflon is more expensive, so there are various other materials with costs and temperature resistances between those of polyethylene and Teflon.



6.2: Corrugated copper coaxial cables

Electrical properties of coaxial cable

Signal loss, or attenuation, is a significant consideration in the design of a cable. The loss occurs in three ways:

- 1. Conductor loss** is a direct function of the conductive properties of the cable's materials.
- 2. RF leakage** is a measure of the effectiveness of a cable's shielding.
- 3. Insulation loss** is a fixed degree of attenuation inherent in the material of the cable's dielectric layer.

Attenuation is measured in decibels; in the specific case of transmission lines, attenuation is expressed in either decibels per 100 feet of cable length or decibels per 100 meters of cable length.

How well these losses are managed depends on such factors as the size and length of the cable, the conductivity of the materials used in the cable, the frequencies traveling along the cable and the effectiveness of its shielding. There are general physical rules governing how these factors impact attenuation, such as:

- **Cable size.** As a rule, a cable's conductor loss will decrease as its size increases. This is due to a larger cable's broader cross-section and its corresponding increase in conductive area.

- **Cable design.** Solid outer conductors allow less RF leakage than braided ones, though at the expense of flexibility.
- **Dielectric material choice.** By choosing any particular dielectric material, you can anticipate a predictable level of insulation loss. As explained earlier, air dielectric offers the lowest insulation loss, while solid dielectric comes with the highest loss.
- **Assigned frequency.** All three types of attenuation directly increase as a function of the frequency of the cable's signal. The higher the frequency and the shorter the wavelength, the greater the loss in any given cable.

This complex balancing act of performance, ease of handling, and cost means no single transmission line design is ideal for all, or even most, circumstances. Each application demands its own unique compromise between these factors.

Characteristic impedance

Characteristic impedance, commonly called "cable impedance," is a measurement of the electrical resistance of an RF transmission line as measured in ohms. The figure is derived by a complex formula involving the ratio between the cable's two conductors. As a general rule the industry standard impedance for RF cable is usually 50 ohms (though some applications require 75 ohms).

Attenuation

Measured in decibels (dB), this is the loss of power experienced by an RF signal as it moves from one point to another. Transmission line attenuation is expressed in either decibels per 100 feet (dB/100 ft) of cable length, or decibels per 100 meters (dB/100 m) of cable length.

Ohm

The unit of electrical resistance, or impedance. In terms of RF transmission lines, ohms refer to the inherent, or characteristic, loss over a length of cable.

This expected degree of impedance can be affected by imperfections or damage in the cable itself. A deep dent in the outer wall of a coaxial cable can cause its impedance to vary from its standard level. This disruption is called a “discontinuity,” or a change in the distance between the inner and outer conductors, as you might see from a squashed cable. The signal reflects within the cable, creating the same loss of performance as a mismatch between cable and antenna (Chapter 3).

This is one reason a cable’s flexibility and crush resistance are such crucial factors—damage during installation is a frequent source of discontinuity and can be expensive and time-consuming to remedy.

Velocity of propagation

Simply stated, the velocity of propagation within a coaxial cable is the speed at which a signal can travel along that cable. Velocity is governed by the amount and type of dielectric used, and is expressed as a percentage of the speed of light. It can range from 67 percent for solid dielectric cables up to 92 percent for air dielectric cables. However, since the speed of light is more than 670 million miles per hour, velocity is rarely a concern in itself, though there are exceptions. For example, velocity becomes significant in cases where phasing is required.

Power handling capability

The amount of power a particular transmission line can handle depends on two thermal factors: the ambient temperature (that is, the air around the cable) and the temperature of the cable itself while operating.

As we’ve seen, power loss is inherent in any cable design, and is dependent upon the kind of dielectric used in the line. This lost RF power translates to heat, so the greater the attenuation within a cable, the more heat it will generate from that lost energy. Likewise, the greater the frequency passing along any given cable, the more heat it will generate as a function of loss.

Heat resistance is a critical factor in cable design. For instance, foam dielectrics begin to soften near 180 degrees Fahrenheit, so an engineer choosing the right transmission line will need to be certain the combined internal and ambient temperatures won’t exceed 180 degrees. If the cable exceeds its limit, the softened dielectric will allow the inner conductor to shift, creating a discontinuity. If it should contact the outer conductor, the result would be a shorted cable. To help engineers make the right choice and prevent such failures, cable manufacturers like CommScope rate each type of cable for certain power levels at certain ambient temperatures.

RF leakage

As its name suggests, RF leakage is a function of the physical ways an RF signal can “leak” out of a transmission line. In the case of a cable with a braided outer conductor, there are countless tiny openings in the cable. As with a leaky garden hose, the more power or pressure you apply, the more significantly those leaks affect performance.

In addition to attenuation, RF leakage causes another challenge when several high-power braided coaxial cables are arrayed in close proximity to each other. The leakage can create interference between the cables at their endpoints, such as when they connect to antennas, multi-couplers, duplexers and so forth (Chapter 8). Faulty connections can make this problem worse.

As with power handling, RF leakage is included in a cable’s specifications to help engineers choose the best option for any particular configuration—especially in circumstances where many cables terminate close together.

Cable life expectancy

The expected useful life span of a coaxial transmission line depends largely upon environmental factors. Since engineers have little control over these factors, they must compensate by choosing the right design with the right materials to assure the longest possible life span.

The composition of the cable’s outer jacket is one of the more obvious considerations. Most flexible and semi-flexible coaxial line jackets use polyethylene, polypropylene, or polyvinyl chloride (PVC). All three options are vulnerable to long-term sun exposure, so manufacturers incorporate carbon black into the resin to improve the jacket’s resistance to aging under ultraviolet light, which can extend their operational lives.

This improvement is the reason coaxial cable used in most applications is black—particularly outdoors.

Moisture and humidity are important factors as well. While water can infiltrate through tiny nicks, cuts or age cracks in the cable, the most common form of moisture infiltration is through improperly sealed connectors on the ends of the cable. Even humid air present inside the connector can condense as temperatures fall, resulting in liquid water that wicks deeper into the cable along the outer conductor’s braid. This can potentially corrupt the entire cable and short the inner and outer conductors—particularly in the connectors themselves. The result is increased signal reflections within the cable and degraded performance due to passive intermodulation (PIM).

Environmental factors

The climate and setting of a cable installation dictates what kind of cable should be used.

Considerations include:

- Sunlight UV exposure
- Humidity and moisture
- Temperature extremes

Passive intermodulation (PIM)

PIM is interference that occurs at a system’s non-linear points—such as junctions, connections or interfaces between dissimilar metal conductors—creating interfering frequencies that can decrease efficiency. The higher the signal amplitude, or power, the greater the effect.

Coaxial connectors

The high costs of PIM make connector technology a critical part of efficient connectivity, since connectors are one of the most common sources of this crippling interference. As the number of modern RF applications has grown, the technology used to connect a cable to its terminus has evolved. The simple designs created in the 1940s for military uses have diversified and improved into a variety of types such as these (Figures 6.3 through 6.11).

- **UHF connectors** are the oldest and most popular type still in use for two-way communications. They are rugged, reliable and easy to install, which is why they are the preferred choice for applications with frequencies up to 300 MHz.
- **BNC connectors** are small, quick-disconnect versions with a bayonet-style locking coupling. These are often used on narrow cables connecting equipment.
- **TNC connectors** are similar to BNC connectors, but include threaded connections that keep them secure in environments where vibration is a concern.

6.3: 4.3-10 connectors, the newest industry standard	6.4: DIN coaxial connector	6.5: Type N connector
		
6.6: BNC coaxial connector	6.7: TNC coaxial connector	6.8: EIA flange coaxial connector
		
6.9: NEX10 coaxial connector	6.10: 2.2-5 coaxial connector	6.11: Ganged connector
		

- **Type-N connectors** are an industry favorite for RF communications with frequencies above 300 MHz, where UHF connectors are not suitable. Type-N connectors may be rated to perform at 10 GHz or even higher.
- **EIA flanges** are used primarily on pressurized air dielectric cables operating above 450 MHz. These connectors offer the standard 50 ohms of impedance and typically offer higher voltage characteristics than Type-N connectors.
- **DIN (Deutsche Industrie Normenausschuss) connectors** are available in several sizes and have been the preferred connector type for a while due to their large cross section, which is greater than that offered by Type-N connectors. However, due to the rising need to control PIM in the RF path and the increasing density of connection panels on antennas and other RF equipment, DIN is giving way to the newer 4.3-10, Nex10, and 2.2-5 connector types.
- **4.3-10 and other new small form factor connectors** like Nex10 and 2.2-5 are quickly becoming the newest industry standard RF connector for 4G/LTE and small cell networks because of their small size and ability to mitigate PIM interference. They feature a radial contact and low coupling torque requirements, making it easier to ensure a proper

installation and solid contact. The separation of their mechanical and electrical planes offers superior PIM characteristics as compared to DIN equivalents, and their smaller footprint allows for more connections in crowded interfaces—a very useful benefit for more sophisticated multiport antennas being used today.

Installation step 1: Cable choice

When it comes to the practical process of planning a cable deployment, we've shown that there are many variables that must be anticipated and balanced for the best result. As discussed above, choosing an appropriate cable depends on knowing:

- The frequencies it must carry
- How much loss is tolerable
- The environment where it will be installed
- What kind of budget limits exist

In most cases, there will be more than one acceptable cable solution for any one of these four criteria, but the key is to get the greatest possible balance of benefits among all four factors. In the real world, the best decision may be based on dollars as much as it is on wattage.

For instance, if we look at cost as the primary driver, we see that smaller-diameter cables cost less to purchase and install, but will need more upkeep and

eventual replacement. We may also consider a less expensive option with a higher rate of loss—intending to compensate for that loss through greater RF power generation on one end of the cable or increased antenna gain on the other.

Installation step 2: Field testing

Once you have selected and installed the cable that best performs to your application's priorities, the process of fine-tuning that performance can begin. There are three tests you would likely perform: inner and outer conductor continuity, shorts between conductors, and a voltage standing wave ratio (VSWR) test.

The first two tests are simple and direct measurements of impedance in the cable, performed with an ohmmeter. Any physical disruption of the cable's integrity would be revealed in a non-standard level of impedance, and you could begin inspecting the cable for the source of the problem.

The third option, the VSWR test, is an indirect but ultimately more revealing measurement of overall line performance. Basically, the VSWR test measures the amount of signal reflection taking place within the cable. Measuring both forward and reflected power with a wattmeter, you can compare the values against the cable manufacturer's conversion chart for that particular type of cable.

If everything is functioning correctly, the observed amount of reflected energy should fall within expected limits. Poorly made connections or connections with mismatched impedance will quickly become obvious. This process is explained in more detail in Chapter 3.

Installation step 3: Troubleshooting

Reduced RF communication performance can be rooted in any number of problems, occurring in any component in the system. When the antenna and transmitter have been ruled out as potential trouble spots, it's time to examine the transmission lines—because a lot of things can go wrong with cables.

Here are just a few things that can impact transmission line performance and cause network efficiency to drop suddenly:

- **Weather.** A good place to start is to visit the site itself and speak to those familiar with recent weather trends. A bad storm, lightning, hail or high winds can damage cables and loosen connectors.
- **Local phenomena.** In addition to weather, other local events can impact performance. Explosions from nearby mining operations, small earthquakes, and even a stray bullet from a hunter's gun have been identified as culprits.
- **Water infiltration.** As discussed earlier, water is perhaps a cable's greatest enemy. Checking connectors for signs of moisture, double-checking

Voltage standing wave ratio (VSWR)

A key measurement of cable performance and signal quality. It quantifies the amount of signal reflected backward along a cable to its source. Theoretically, perfect operation yields a VSWR value of 1.0, or "unity," meaning zero reflections.

their seals, and examining the cable itself for any new damage will help confirm or rule out water as a cause.

Whatever the cause of the performance drop, if damage is identified in a transmission line, it cannot be repaired or taped. It must be replaced completely. Long-term system performance degradation without an obvious proximate cause can be just as serious, and is often caused by cable aging. While metal-sheath cables are almost impervious to aging when properly installed, inferior cables can age and crack with extended exposure to the sun's UV rays and extreme temperatures.

Localizing the problem

If your VSWR measurements reveal a high level of reflection—say, 20 percent above the level indicated by the manufacturer's table—then, most likely, your cable is experiencing an open, a short or a partial short somewhere along its length or in a connector. To confirm this, you could perform the following tests:

1. Open the top of the cable and short the inner and outer conductors (the cable ground should be removed for this). Measure impedance between the conductors with an ohmmeter. An intact cable will show low impedance between the two, while high impedance will reveal damage to the outer conductor. This kind of damage is hard to locate. If economically feasible, replacement may be the best option.
2. Remove the short between the conductors and test impedance again. In this instance, an intact cable will show high impedance, while low impedance may indicate damage to the inner conductor that creates a short somewhere within the cable. The damage required to cause this kind of fault often leaves more obvious traces on the outer jacket and is easier to identify.
3. Examine the connectors themselves. Type-N connectors (and, to a lesser extent, DIN connectors) are particularly vulnerable to misalignment and pin breakage, which can result in a short. Also, as the primary source for any potential water infiltration, it's a good idea to examine any type of connector for signs of moisture. For best results, check connectors during cool weather or at night, where any trapped vapor will have condensed into more visible droplets. As mentioned above, the new 4.3-10 connector type is designed to avoid installation errors and incorrect torque applications, making it less vulnerable to these kinds of problems.
4. Practice good preventative maintenance. Proper installations reduce the need for ongoing maintenance, but vigilance is always to your benefit. Any time an installation is realigned or painted, it's smart to inspect the cables and connectors. Identifying small problems before they become big problems can save a great deal of time and money and minimize lost performance.

In summary, a solid understanding of the construction of cables helps you understand their best applications, where they may be vulnerable, and where to look when a fault is suspected.

Fiber-optic cable in the RF path

The role of fiber-optic cable at cell sites is growing quickly. It is steadily displacing copper coaxial cable, as it can provide faster speeds, greater bandwidth and increased electrical efficiency. This is particularly true where sites have adopted remote architectures, placing radios, amplifiers and other components on top of the tower near the antennas, as we will see below when we discuss fiber-to-the-antenna (FTTA) architecture.

The structure of a fiber-optic cable is simple, with a light-conducting glass core surrounded by cladding and a protective coating (Figure 6.12). Signals propagate through fiber-optic cable as serial light pulses rather than electrical patterns used in copper cabling.

Because fiber-optic cable uses light pulses instead of changing electrical currents, it is much more energy efficient than copper cable and generates no internal heat. Signals also propagate at virtually the speed of light, making it faster than copper; in addition, by using multiple wavelengths (colors) of light, many signals can be sent simultaneously without creating

interference with each other—increasing available bandwidth.

However, fiber-optic cable has to be handled differently than coaxial cable, and installers new to fiber will need training on how to properly install. All fiber-optic cable specifies a maximum bend radius—a measure of how sharp a turn it can make before the core is subject to damage. In crowded deployments, it's possible to accidentally exceed this limit, damage the cable and cause optical power loss.

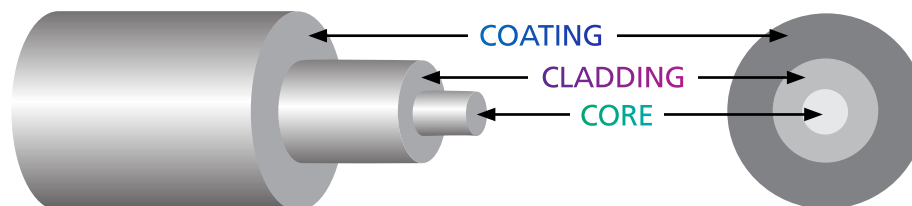

6.12: The structure of a simple fiber-optic cable

Fiber-to-the-antenna (FTTA)

One place fiber-optic cable is seeing a growing amount of use is for fiber-to-the-antenna (FTTA) deployments. FT TA is an extremely efficient way to move network traffic from the tower-mounted components down to the base station at the bottom of the tower. FT TA cabling runs from the enclosure up the tower, where it can be broken out to connect one or more remote radios and antennas.

The fiber-optic cable below can be installed either as separate runs or as a single trunk with a breakout system that feeds fiber to the radios. Additionally, hybrid runs are becoming popular in some regions, which enable faster installation with fiber and power bundled in a single cable or assembly. Breakout system options for FT TA deployments may include a junction box, plug-and-play assemblies, or other structures; see an example below, where individual fibers are joined into a single multifiber cable running down to the base station (Figure 6.13). The antenna is still connected to the radio via a short RF jumper.

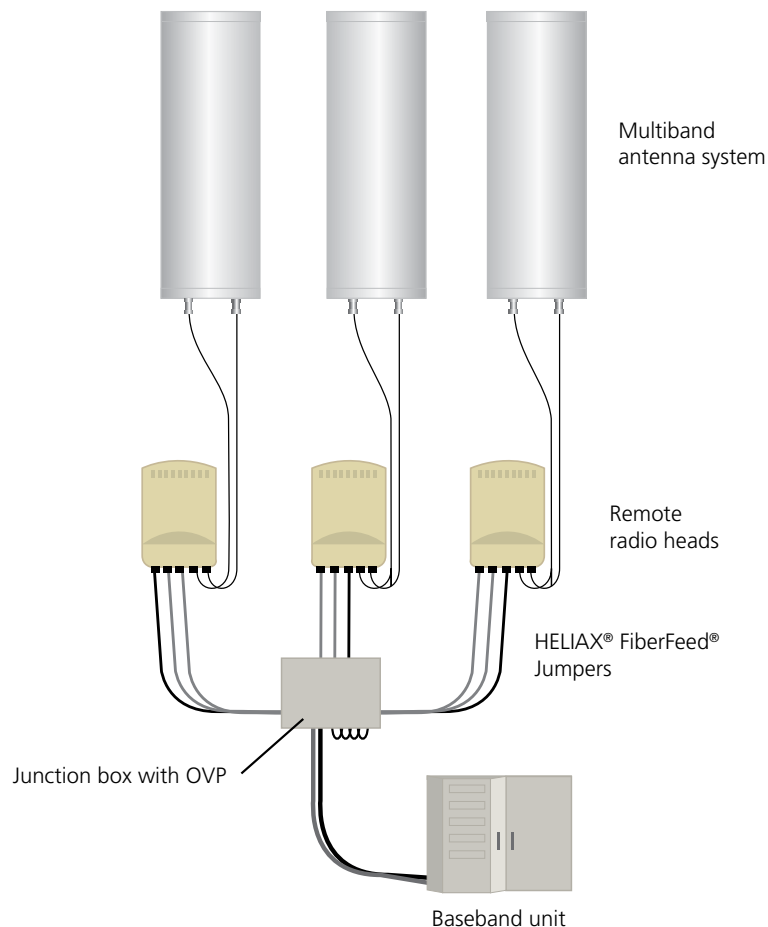

6.13: An example of the structure of an FT TA deployment, with copper cable between antennas and radios, and radios linked by fiber-optic feed cables to the base station on the ground

Hybrid cable

Since fiber-optic cable uses light, not electricity, to propagate signals, it does not carry power to these remote radios. A power cable must be added to provide the power to these devices, and there are a couple of ways to accomplish this—either through discrete (i.e., separate) runs of fiber and copper for power, or through hybrid cable that contains both types in a single sheath. A cutaway illustration of this construction can be seen in Figure 6.14.

Hybrid deployments are now the preferred method for new and upgraded sites for a number of technological, logistical and economic reasons. Chief among these are:

- It is slimmer and lighter than two discrete cable runs, reducing tower weight and wind load.
- It is available in a number of architectures specifically designed to support FTTA sites (see below).
- It reduces the complexity of site infrastructure and reduces SKU count for operators.
- It is quicker to deploy than discrete runs.
- It offers the fiber bandwidth operators need for current and future network capacity needs.

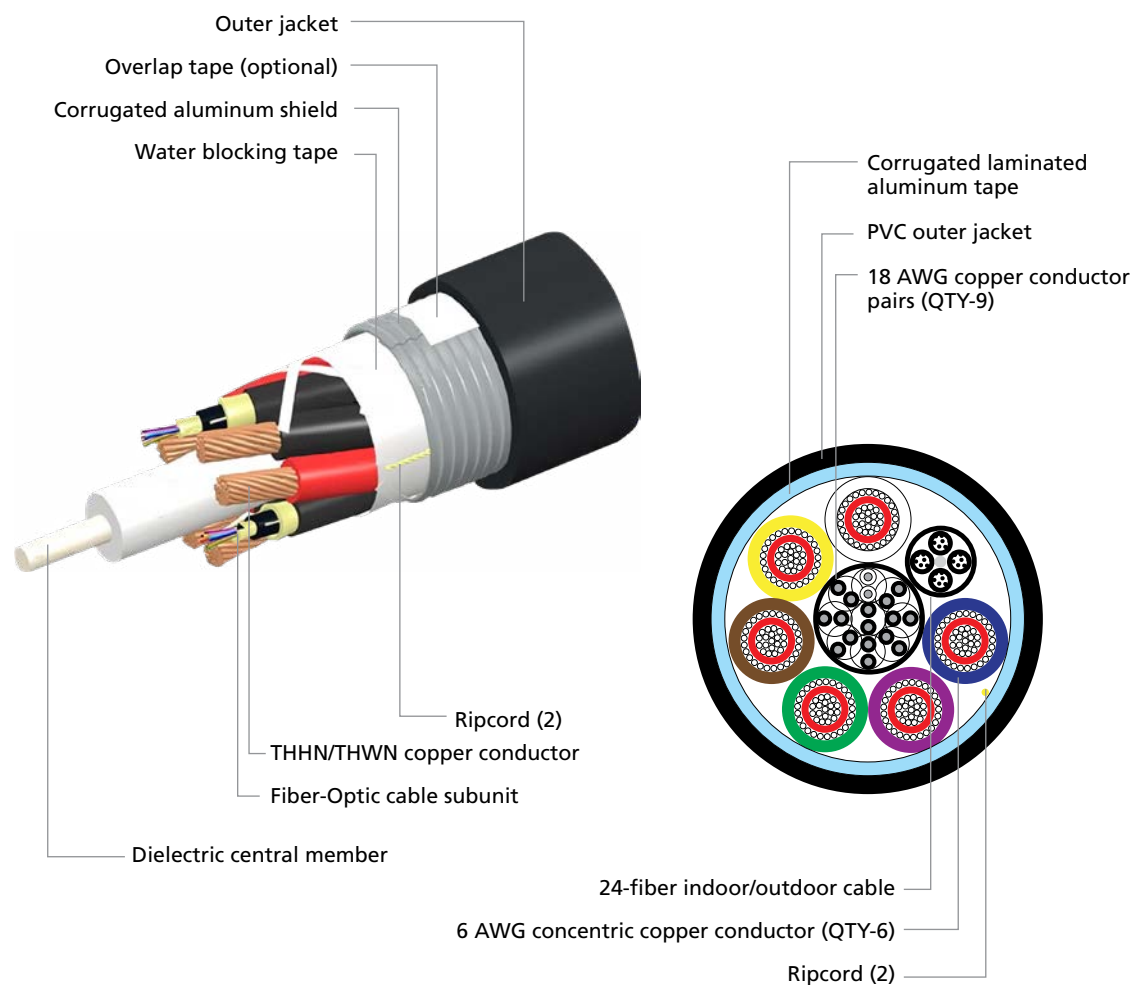

6.14: The internal structure of a hybrid cable

6 | Getting from the air to the network: Cables and connectivity

Hybrid deployments are now the preferred method for new and upgraded sites for a number of technological, logistical and economic reasons. Chief among these are:

- It is slimmer and lighter than two discrete cable runs, reducing tower weight and wind load.
- It is available in a number of architectures specifically designed to support FTTA sites (see below).
- It reduces the complexity of site infrastructure and reduces SKU count for operators.

- It is quicker to deploy than discrete runs.
- It offers the fiber bandwidth operators need for current and future network capacity needs.

There are several ways hybrid cable can break out to components at the top of the tower, depending on the operator's needs and the number of radios involved. Some of these configurations are shown in Figure 6.15.

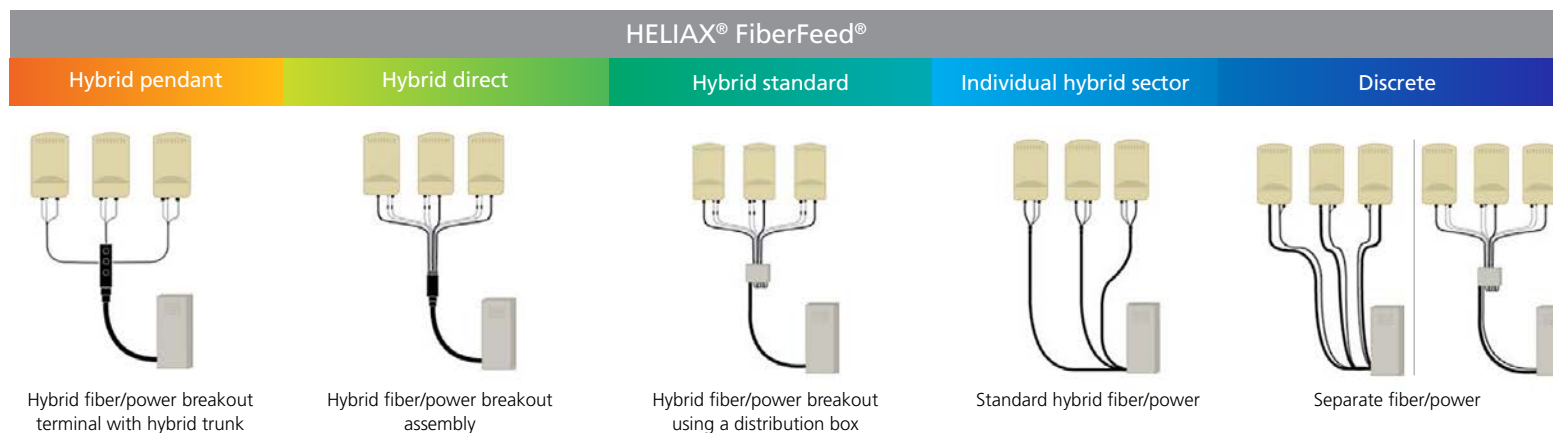

6.15: Examples of FTTA configurations using various breakout methods to bring hybrid cable's data and power connectivity to the tower top

Optical and hybrid cable assemblies

As Figure 6.15 shows, FTTA installations can be accomplished by running only one or two trunk cables up the tower, with some examples supporting a dozen or more individual radios at once. Splicing or connectorizing fiber-optic cable is much more demanding than it is for copper, and much less forgiving of imperfections. Even a speck of dust trapped inside an optical connection can cripple a cable's throughput.

To simplify the work done in the field, CommScope manufactures a number of cable assemblies for both fiber-optic and hybrid cable applications (Figure 6.16). These ensure factory quality, less work required on-site, and reduce the likelihood of installer error, which would otherwise necessitate a return trip up the tower.

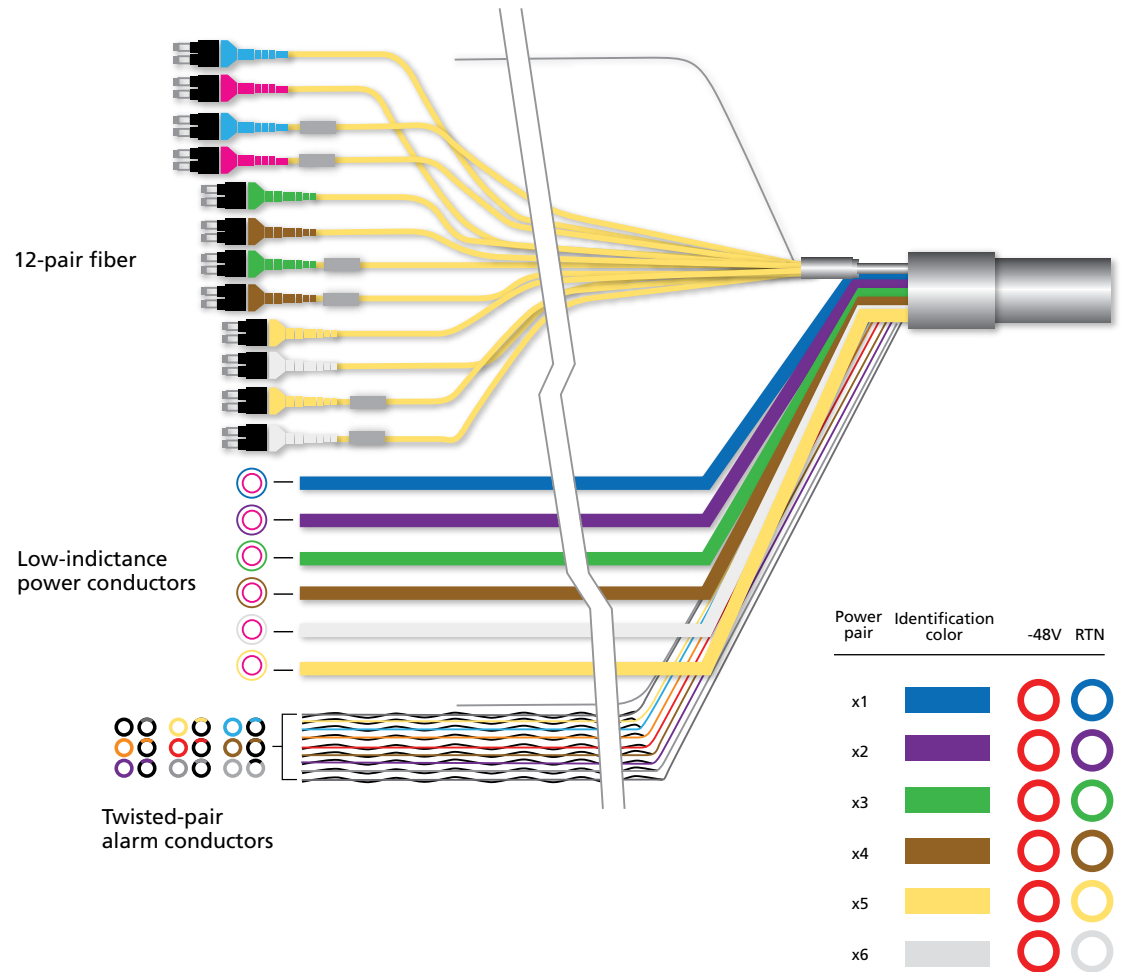

6.16: A hybrid cable assembly for a six-radio installation, featuring 12 pairs of fiber-optic cable, six power cables and a host of alarm-conducting wires

Fiber-optic and hybrid connectors

Connectors are also an important part of fiber-optic infrastructure—particularly in FTTH deployments.

Because they are often located outdoors, the connectors must be rugged enough to withstand the elements without allowing any deflection in the optical signal traveling through them. Because there are so many ways fiber-optic and hybrid cable can be used at a site—depending on the number of connections and the kind of components involved—there is a wide variety of connector types (Figure 6.17). These include:

- LC connectors—duplex uniboot for 2 mm, 3 mm, 3.6 mm and 6 mm OD subunit
- Radial outdoor ruggedized connector (ODC style two to four fibers)
- OVDA outdoor connector with LC duplex interface
- Outdoor ruggedized MPO connector (12 and 24 fibers)
- Standard MPO connectors (12 and 24 fibers)
- SC/APC and SC/PC connectors
- Hybrid connector (power/fiber with LC interface)
- HMFOC 2-12 fiber connections
- Hardened SCAPC connectors
- LC simplex and duplex connectors (900 um, 2 mm and 3 mm subunits)



LC uniboot



Outdoor ODC equivalent (radial)



Outdoor ODVA LC & MPO



MPO

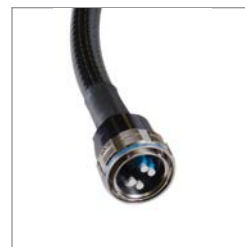

Outdoor hybrid



HMFOC



Hardened SCAPC



6.17: Some of the many different kinds of fiber-optic and hybrid cable connectors currently available

Fiber-optic enclosures

Connectors are not the only way to connect or break out fiber-optic cable. There are also enclosures that can be located almost anywhere, on the tower or at the base, which allow the neat and orderly connection and/or breakout of fiber-optic cable in a compact, weatherproof

package that can sometimes include storage for extra cable—removing the need for additional cutting and termination at the enclosure (Figure 6.18). Power cabling can also be interconnected through these boxes, with optional over-voltage protection (OVP) available.

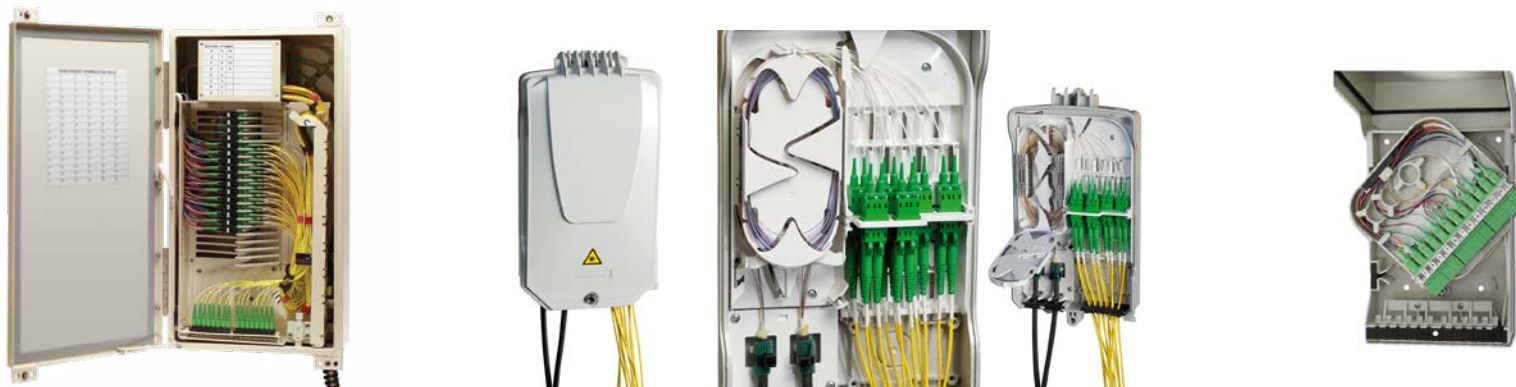

6.18: Different kinds of fiber-optic enclosures that weatherproof complex cable breakouts

Other fiber-optic cable accessories

Because of the special handling requirements of fiber-optic and hybrid cable, there exists a broad ecosystem of accessories designed to make installations simpler, quicker and less prone to mistakes (Figure 6.19). These accessories include:

1. Hangers designed to meet the specified hang distances allowed by the manufacturer
2. Hoisting grips to allow safe, damage-free cable handling
3. Grounding kits that prevent electrical damage

4. Management shelves for fiber optic patching
5. MPO cassettes that provide easy connectivity
6. Fiber Plug and Play box offering a 6RRU solution in 1 convenient storage box.
7. Loop-back connector used for testing

There are many other related accessories and parts. As the use of fiber-optic infrastructure increases at cell sites, the ecosystem of solutions supporting it is also sure to grow.



6.19: Some of the accessories used to support fiber-optic infrastructure

Communication depends on connectivity

While so much of modern RF communication is composed of radio energy radiated through the air, the critical links on either end depend on the right kind of transmission line cable and the right connectors between base station and antenna. This connectivity is what binds thousands of cell towers into a network that can instantly connect two users on opposite sides of the globe.

As a physical link, these cables must be able to flex where they're needed, withstand the punishing elements, and faithfully carry the frequencies that eventually reach you as your internet connection, land-line call, or mobile phone call virtually anywhere in the world.

You live among small-scale examples of the same technology at home. From the USB cord on your computer mouse to the century-old design of your telephone's wall cord, each cable is designed to carry specific frequencies over specific lengths—each one for a unique purpose.

As a leading provider of coaxial and fiber-optic products for networks all over the world, CommScope is at the forefront of the race to develop innovative solutions that will push the limits of speed, capacity and efficiency in RF networks.

Chapter 6 summary

RF transmission lines:

- The bridge between base station and antenna
- Adapted from designs once used just to carry electricity

Coaxial cable:

- Characterized by insulated inner and outer conductors
 - Solid dielectric
 - Air dielectric
 - Foam dielectric
- Mechanics and materials:
 - Copper used for inner conductor
 - Copper or aluminum used for outer conductor
 - Polyethylene used for dielectric insulation

- 4.3-10 connector is the emerging standard for its superior PIM performance and small footprint
- Fiber-optic cable is seeing increasing use in cell sites
- Hybrid cable adds a power line to the fiber-optics
- FTTA connects radios and base stations with increased bandwidth, speed and efficiency
- Fiber-optic cable is delicate and requires its own mounting and interface solutions

Clearing the connections: Overcoming passive intermodulation (PIM)

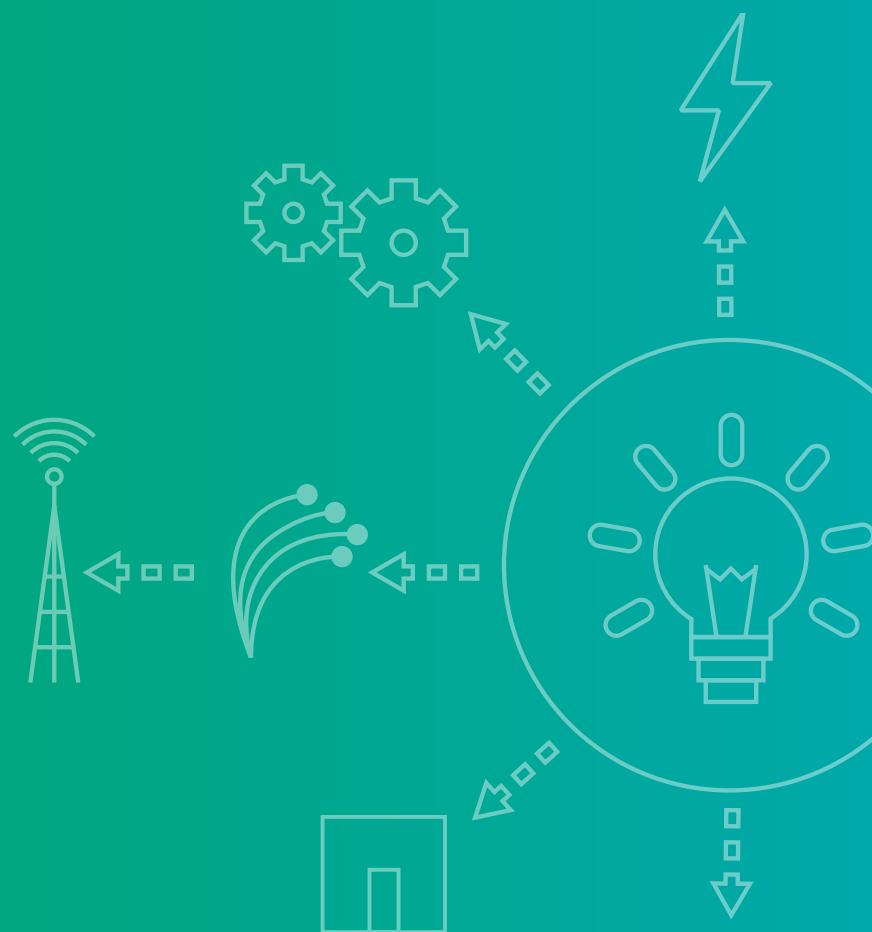

Chapter 7

Clearing the connections: Overcoming passive intermodulation (PIM)

It's a fact of life for electronic devices: when something isn't working correctly, we check the connections. From the most complex cellular transmission system to the simplest toaster, junctions between cables and components are the most likely place for problems to occur.

But, beyond the obvious culprits like poor connections, water infiltration or mechanical issues, a communications system's connections can also play host to other problems. One example is passive intermodulation (PIM), an inherent product of the system's frequencies and their associated harmonics. PIM can create undesirable sideband frequencies that interfere with the system's assigned frequencies. It takes a knowledgeable partner like CommScope to choose the right components and assist in the design and installation of a communications system.

PIM sources

The growing demand for wireless services has increased the complexity of system design and the resources to support that demand. As a result, there are more RF components, configurations and spectrum bands utilized in the RF path. Included in these additional components are passive devices that can contribute to PIM. Understanding where PIM comes from, we can proactively address it and its impact on the system noise floor.

Now that we have developed an understanding of the system-level impact of PIM, we will describe specifically how PIM is generated and how it can be mitigated.

Generally speaking, intermodulation is the result of two or more frequencies (often, a duplexed system's transmitting frequencies) interacting with one another according to certain mathematical relationships related to their specific frequencies. The effect creates spurious

Passive intermodulation (PIM)

A potential side effect of having more than one high-powered signal operating on a passive device such as a cable or antenna.

PIM occurs at non-linear points in a system, such as junctions, connections or interfaces between dissimilar metal conductors—creating interfering frequencies that can decrease efficiency. The higher the signal amplitude, or power, the greater the effect.

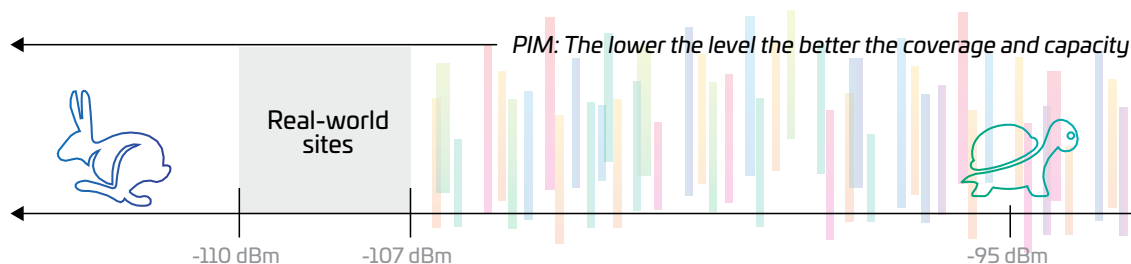

7 | Clearing the connections: Overcoming passive intermodulation (PIM)

signals that contribute to noise and interfere with the system's operation.

Passive intermodulation is a particular kind of intermodulation that takes place in the passive parts of a system such as cables and antennas—often at connections that create nonlinearity in the system.

As the complexity of communications systems has increased, so has the potential for PIM—making

managing its effects a top priority for service providers. In a cellular base station, for example, a transmitting frequency can create PIM interference in its own receiving frequency, or vice versa. Where PIM occurs depends on the separation of the two main frequencies, as shown in the chart below (Figure 7.1)

Nonlinearity

A location within an electrical circuit where voltage does not remain consistently proportional to power. This effect is caused by imperfect connections between components and cables.

Understanding 2A-B

TX (F1) or A = 869 MHz

TX (F2) or B = 894 MHz

2A-B RX PIM = 844 MHz
Third-order

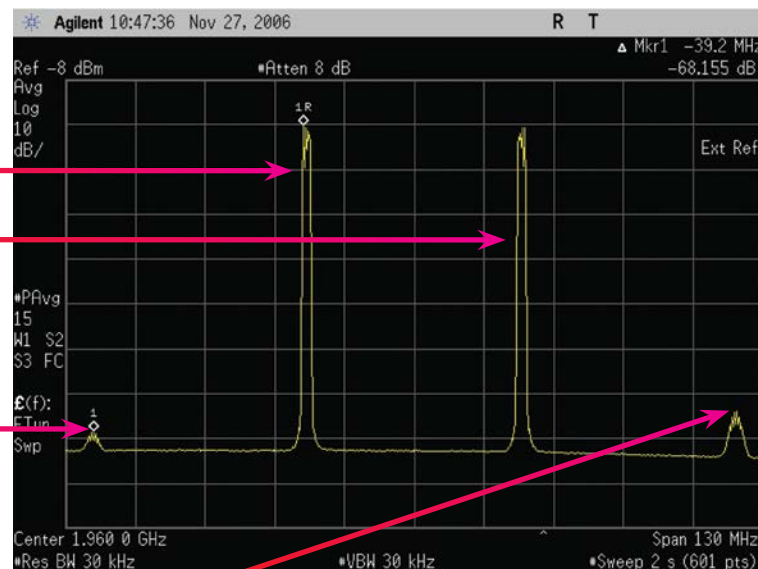

2A-B RX PIM RX PIM

7.1: Calculating where PIM will occur, based on two example frequencies, A and B; in this example, PIM occurs at 2A-B (a common third order product) and again at 2B-A

Orders of PIM

Since PIM is the result of mixing two or more wireless frequencies, their products may or may not interfere with the site's desired frequencies—but they also combine at multiples of that frequency. These combinations—called second-order, third-order and so forth—are additional PIM sources. Lower-order PIM is more disruptive, but higher-order PIM covers more bandwidth (Figure 7.2). These multiples are called PIM products.

PIM challenges in 4G/LTE networks

While PIM is problematic for 3G networks, it is a much greater challenge to more highly modulated 4G/LTE networks. Because LTE receivers are so sensitive—approaching -120 dBm—even a small amount of PIM can cripple network performance. In fact, just 1 dB lost to PIM can reduce a site's coverage by 11 percent. When sensitivities are reduced to about -95 dBm, the 4G/LTE network slows to a crawl. So, amounts of PIM that may have been workable in a 3G deployment are generally not tolerable in a 4G/LTE upgrade.

To maintain acceptably low PIM effects, a 4G/LTE network should maintain a threshold of -130 dBm, which is at least 10 dB below the receiver's sensitivity.

Decibels (dB)

In the context of RF communications, a measurement of power, such as signal strength, compared to another measurement of power, e.g., the margin between signal and interference.

Decibels relative to carrier (dBc)

A measurement of the ratio of a signal's strength (dB) relative to the carrier strength (c). A positive figure means a signal exceeds the carrier; a negative figure means it is less.

Decibel-milliwatt (dBm)

An absolute measurement of power (dB) referenced to one milliwatt (m).

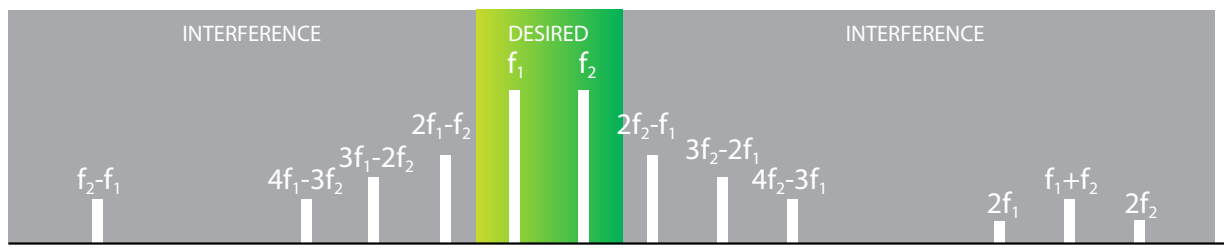

7.2: Orders of PIM relative to a site's desired frequencies

7 | Clearing the connections: Overcoming passive intermodulation (PIM)

Managing PIM

Since we don't always have the freedom to select frequencies that avoid PIM issues, we need to look at other methods of reducing its influence in our communications system. Reducing PIM levels starts with reducing nonlinearity in the circuit.

Nonlinearity in a passive RF circuit typically results from current rectification at the conductor joints and mechanical junctions. Resolving nonlinearity generally means improving connections throughout the RF path of the system. This means addressing problems such as:

- Improper connector attachment
- Poorly torqued connections with incorrect contact pressure
- Contamination or corrosion of conducting surfaces
- Inadequate plating on rust-prone ferromagnetic components
- Poor connections due to cold solder joints

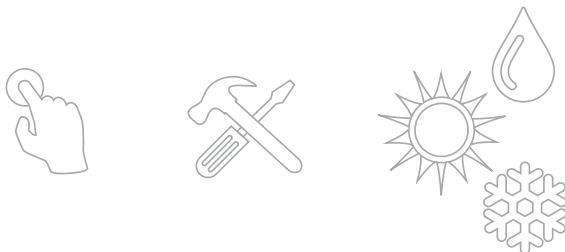

The most common and visible contributors to high PIM levels in the system are associated with the mechanical and physical integrity of the connections in the RF path. Therefore, those who deal directly with the RF components in the field—such as installers, service technicians and test engineers—are integral in the battle against PIM. They will require training in proper field installation, proper use of PIM test equipment and a fundamental understanding of PIM.



In order to manage PIM, we also need to understand the environment in which we are performing the PIM testing. For a manufacturer, it is now common for PIM to be tested in a controlled RF environment such as an anechoic chamber. This is done to ensure the device under test has an isolated and “quiet” RF environment to confirm the PIM performance as it relates to the published manufacturer specification.

System PIM calculators

Reducing PIM in the RF path is important and challenging. CommScope provides several PIM system calculators to support your RF path analysis.



- RF Path Calculator (Global)



- Universal Band and Block PIM Calculator

Download the latest tools [here](#).

7 | Clearing the connections: Overcoming passive intermodulation (PIM)

Field testing presents an entirely different set of challenges if PIM performance testing is required. This is not an isolated or “quiet” RF environment. This noisy RF environment can negatively impact PIM or provide false PIM levels that are a direct result of the environment. In other words, you may obtain PIM levels in your testing that are not reflective of the actual device under test, but rather the RF environment in which it is tested. Shown on the next

page are some examples of base station antenna testing where the environment impacted the PIM measured in the field.

Although conditions such as external RF signals or the test environment may not be controlled, the selected components, installation practices and testing are within our control. Education and awareness are the first steps in managing the difficulties associated with field PIM testing.



7.3: PIM measurements of components under various field conditions

7 | Clearing the connections: Overcoming passive intermodulation (PIM)

Researching, testing and installing

The severity of PIM is directly related to signal amplitude, or power. That's why PIM performance of different RF components specify power levels along with their other properties. Typically, this figure is calculated by applying two signals of close frequencies at 20 watts (+43 dBm), the industry standard for PIM testing. This standard helps assure that comparisons between different products yield meaningful answers.

Understanding the PIM properties of components like cables, connectors, combiners, filters, tower-mounted amplifiers and antennas allows you to design a system



Video: CommScope filter products—designed for PIM excellence

with minimal exposure to potential PIM issues. It's a meticulous process, but it's essential to preventing potentially crippling PIM problems later on:

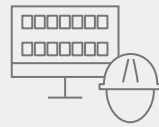

- **Choose a knowledgeable provider** who has demonstrated experience in the PIM specification of their products—one who can help you make the right component choices. CommScope makes this expertise freely available to our customers.



- **Test your component performance** against PIM specifications to assure trouble-free operation later on.



- **Use trained installers** certified in preparation and installation techniques. Since they will be managing connections—and connections are the primary source of PIM—their skill is your best guarantee against problems.

By following these recommendations, you can count on an RF system that will operate efficiently—virtually free of troublesome PIM effects.

7 | Clearing the connections: Overcoming passive intermodulation (PIM)

PIM: best addressed at the planning stage

In engineering, connections are perennial trouble spots. Each connection, junction and interface is an opportunity for something to go wrong, including PIM.

While PIM is an annoyance in 2G and 3G networks, the higher orders of modulation employed in 4G/LTE networks make them much more vulnerable to its effects. This is what drives CommScope—and, indeed, the entire industry—to treat PIM as one of the most

critical challenges of the 4G/LTE era, and a looming threat to the eventual rise of 5G in the marketplace.

The only way to design the system to mitigate PIM is to study and test the PIM specifications of the components comprising that system, which is why partnership with CommScope is so vital. We provide the experience and insight to spot potential trouble early in the process.

Chapter 7 summary

Passive intermodulation (PIM):

- Caused by interactions between multiple frequencies and their harmonics
- Can cause transmission or receiver frequencies to interfere with each other
- Occurs as a byproduct of nonlinearity in a circuit, such as at a connection
- A critical consideration in the selection of components and installation of those components in an RF system

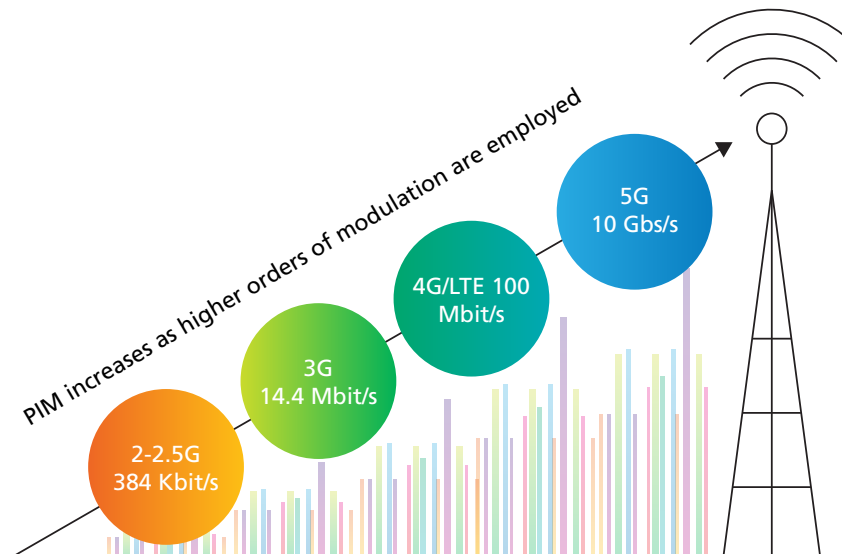

Getting the most from every cycle: Spectrum management

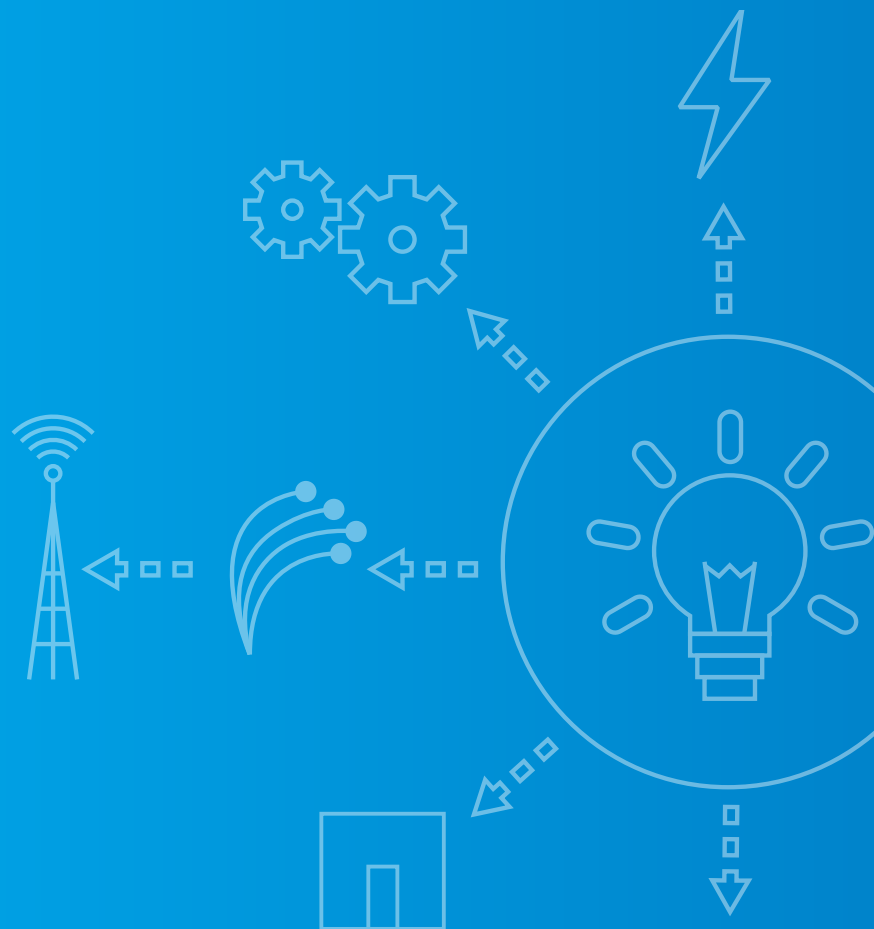

Chapter 8

Getting the most from every cycle: Spectrum management

Of all the materials that go into creating a cellular network, the rarest and most precious isn't the copper in the transmission lines, the fiber optics in the backhaul or even the land where cell sites are located. In fact, it's not a material at all—it's spectrum, the "air" that networks breathe.

Spectrum is, by nature, a limited resource. You can't manufacture more of it simply because demand has increased, or because more wireless operators have entered the market. Most available spectrum is already assigned and in use all over the planet, and regulatory releases of additional spectrum are few and far between—and also very expensive.

Therefore, wireless network operators everywhere have a deep and vested interest in managing the spectrum they have in order to provide the most capacity and earn the most revenue possible.

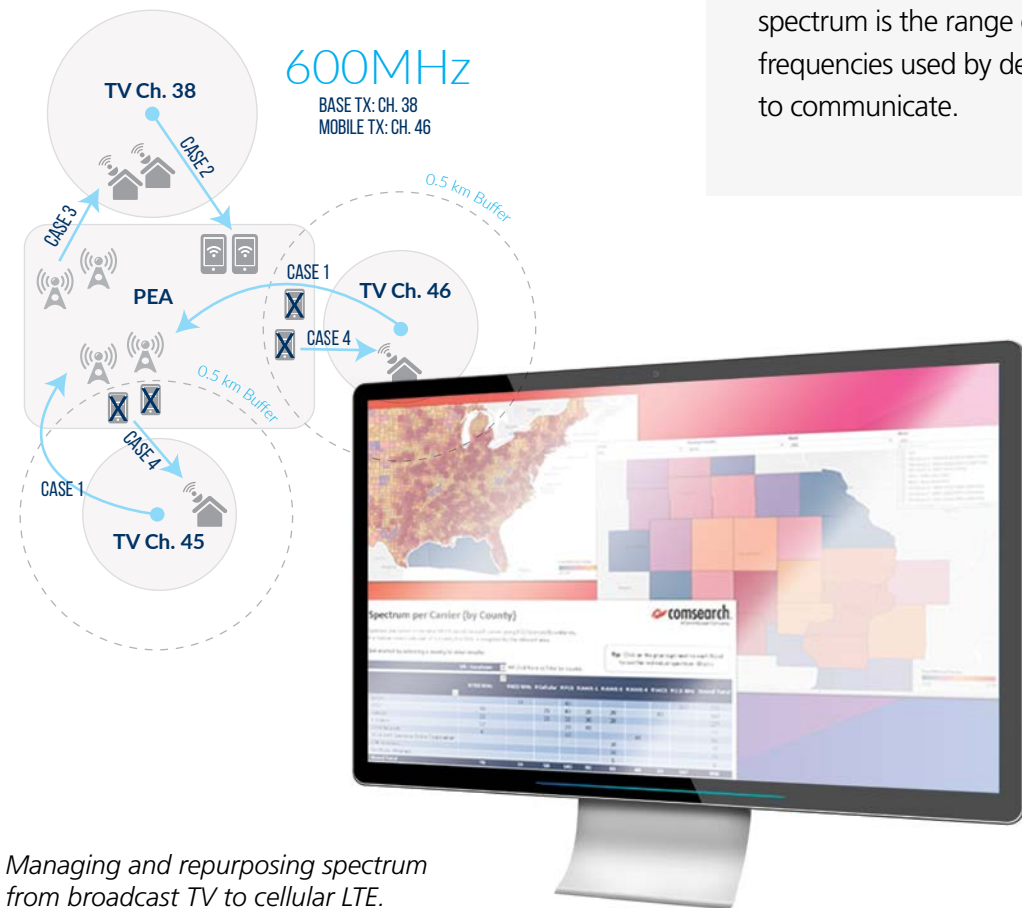

Managing and repurposing spectrum from broadcast TV to cellular LTE.

Spectrum

The electromagnetic (EM) radiation covering particular frequencies. As it relates to wireless systems or devices, spectrum is the range of radio frequencies used by devices to communicate.

What does spectrum look like?

All radios, including those used for cellular communications, count on the availability of specific frequencies in order to operate. For this reason, the licensing of spectrum from operator to operator, and from area to area, is strictly regulated to prevent different radios from interfering with one another. So, what does the spectrum look like?

Radio frequencies include a wide range of the EM spectrum, as you can see in Figure 8.1.

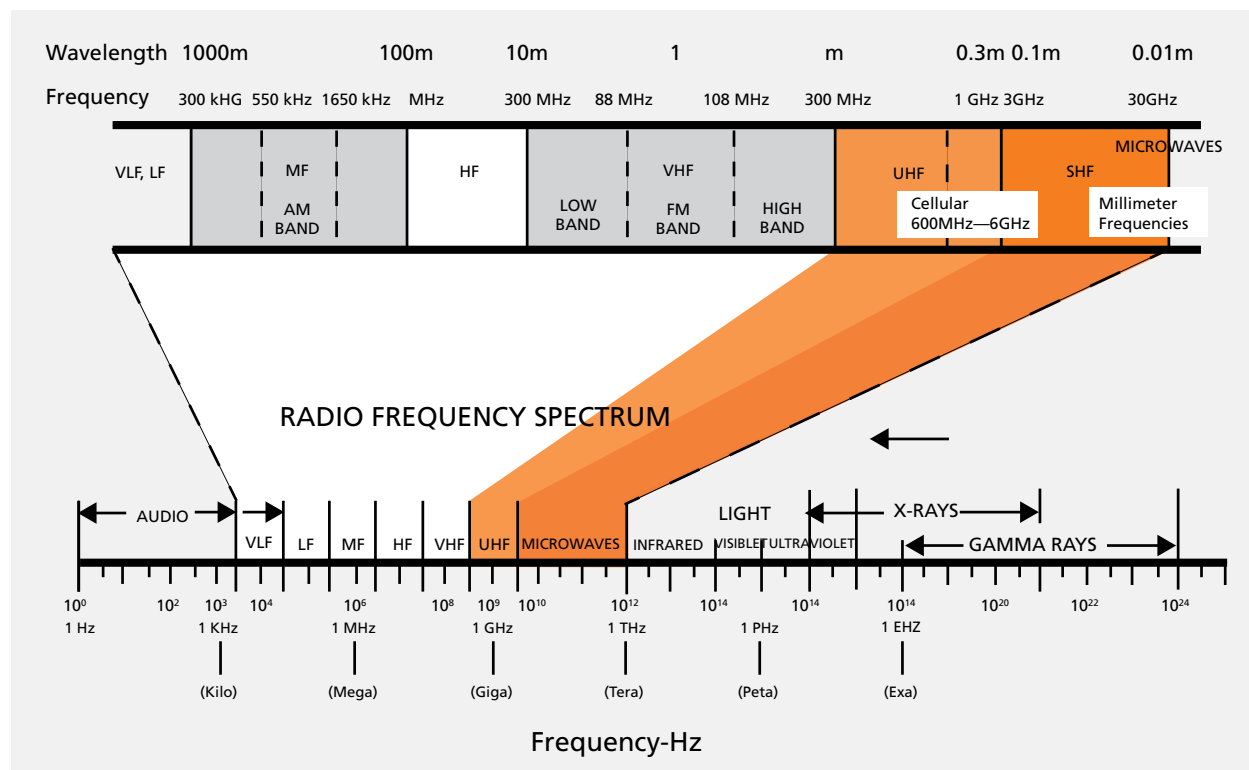

8.1: RF frequencies within the electromagnetic (EM) spectrum

Getting licensed spectrum

To secure the legal right to use parts of the RF spectrum in a particular market, the wireless operator must acquire the relevant license. This can be done several ways. One way is to apply to the Federal Communications Commission (FCC) for a license to use specific frequencies—for example, licensing for microwave backhaul. Another way is to participate in a spectrum auction managed by the regulating government agency. In the United States, the FCC is the body running spectrum auctions. Other countries have their own regulatory agencies.

Of course, because spectrum is a finite resource in our age of skyrocketing demand, the winning bids for such auctions can range in the hundreds of millions to billions of dollars. In auctions that ended in January 2015, for instance, the FCC netted a record-breaking \$44.9 billion for advanced wireless services (AWS-3) bands covering

1755 to 1780 MHz and 2155 to 2180 MHz. This total was composed of 31 bidders winning 1,611 licenses overall.

Other LTE FDD/TDD auctions

Other auctions have been held for the wireless communication service (WCS) bands in 1997, the personal broadband communication (PCS) bands in 2004 and many others all over the world.

600 MHz

Most recently, the 600 MHz band was auctioned by the FCC in 2017. This band was released for auction because it contains spectrum that was once dedicated to television broadcasts but is now being repurposed for LTE networks.

Wireless operator T-Mobile identified 1.2 million square miles of potential coverage for this band in the United States and secured a substantial amount of available spectrum (Figure 8.2).

Sharing LTE bands: FDD and TDD

To allow full duplex—that is, two-way—communication, LTE bands employ two main methods. They are frequency division duplexing (FDD) and time division duplexing (TDD).

FDD works by using separate frequency bands for base station downlink transmission and uplink reception, while TDD refers to duplex communication where the downlink is separated from the uplink by assigning different time slots in the same frequency band. TDD requires precise synchronization of base stations to avoid passive intermodulation (PIM) interference.

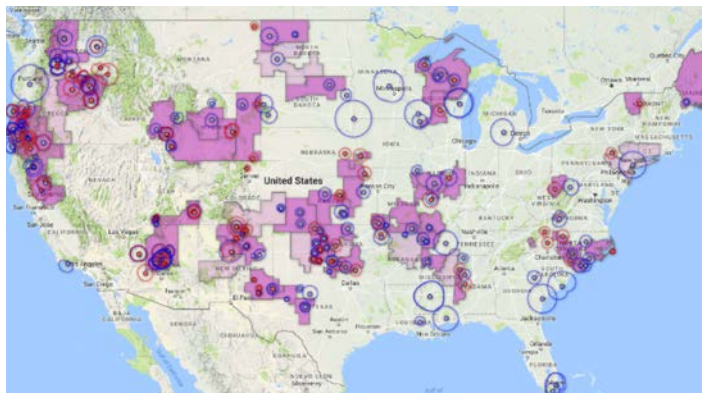

8.2: T-Mobile's newly-acquired 600 MHz holdings as of 2017

Source: <http://www.spectrumgateway.com/600-mhz-spectrum>

Millimeter wave bands

High-frequency millimeter wave bands hold the promise of enhanced network capacity. The FCC is currently planning to auction the 28 GHz block at the end of 2018, and the 24 GHz block sometime shortly after. While these high-frequency, high-capacity bands are coveted for the huge amounts of bandwidth they offer, they also have significant propagation limitations attached to how and where they can be effectively used.

Buying or swapping spectrum

Just like managing a baseball team, different wireless operators have unique network needs and resources available to them. It can be mutually beneficial for operators to purchase, sell or lease licensed spectrum as a means of improving service and profitability. Such

leases may be for an individual market or multiple markets. Such swaps must be approved by the governing regulatory agency.

Unlicensed spectrum

Unlicensed spectrum is available to users without having to secure a license from controlling regulatory agencies. Applications using these frequencies include such everyday items as Wi-Fi, garage door openers, wireless key fobs and so forth. Unlicensed spectrum can be accessed by anyone, but interference is managed through power limitations and technology considerations rather than licensing specific frequencies.

Because licensed spectrum is so hard to obtain, wireless network operators have turned to using unlicensed spectrum on a limited basis. A summary appears in Figure 8.3.

Unlicensed spectrum

Ranges of the EM spectrum that do not require a license to use. Unlicensed spectrum can be accessed by anyone but introduces challenges of interference when competing signals occur nearby.

Unlicensed LTE deployment possibilities

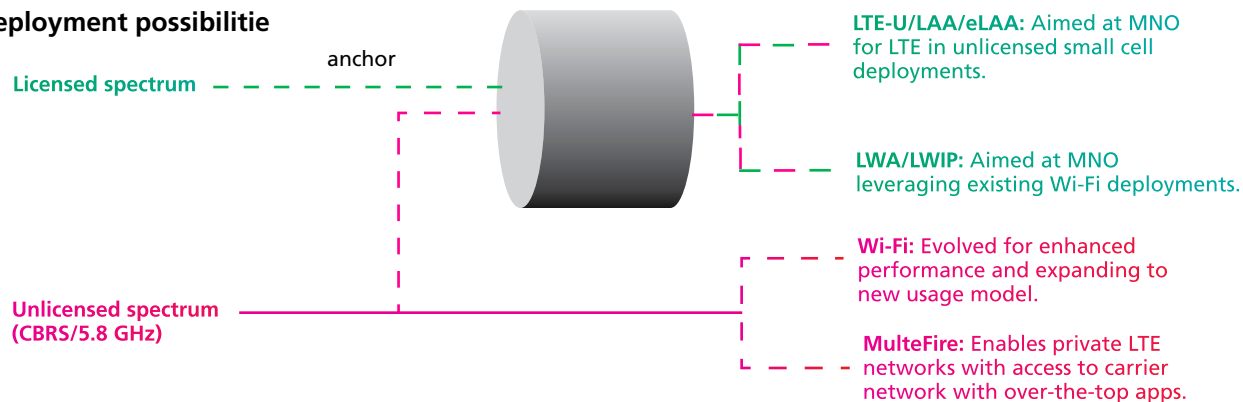

8.3: How licensed and unlicensed bands can work together to carry wireless network traffic

CBRS and dynamic sharing

Another spectrum option in the United States is the Citizens Band Radio Service (CBRS), which operates in the 3.5 GHz band. This spectrum has traditionally been used by the U.S. military for operation of shipborne radar, among other uses. In order to tap into this spectrum, an operator must employ a spectrum access system (SAS) that manages spectrum assignments across all spectrum users. The SAS gives first priority to military and other incumbent users, second priority to priority access license (PAL) users, who acquire licenses to use CBRS spectrum through an auction, and finally third priority to general authorized access (GAA) users. This spectrum management scheme is called “dynamic sharing,” as it apportions spectrum assignments among users on a dynamic basis. Wireless operators are expected to leverage CBRS in markets all across the United States.

Managing what you have

As difficult as it is to obtain spectrum—whether bought at auction, traded from another network or approved to run on unlicensed bands—the real challenge comes when it’s time to manage that spectrum for maximum utility. Here, it’s important to know the strengths and weaknesses inherent in the bands you’re using.

For instance, higher-frequency bands generally support wider channel bandwidths, which provide greater capacity. However, their propagation characteristics limit them to nearly line-of-sight configurations. Lower frequencies with narrower channel bandwidths travel farther and are less affected by obstacles, but generally don’t provide the capacity modern networks (particularly 5G networks) require.

This introduces related challenges in how to construct or upgrade cell sites to use broad ranges of spectrum. For example, when building, site location becomes increasingly important due to propagation limitations of higher frequencies. When upgrading existing sites, the addition of larger antennas needed for lower bands to the tower introduces wind and weight load concerns.

Interference and filters

New sites are hard to secure and expensive to build, so an attractive alternative is to upgrade existing sites to support more spectrum options, or to add new infrastructure to a co-sited arrangement with another network. In both cases, interference can be a significant challenge. We cover common interference challenges in Chapter 6 (isolation) and Chapter 7 (passive intermodulation, or PIM).

- PIM is interference generally caused by discontinuities in the RF path itself, such as moisture in a transmission line, an improperly torqued or corroded connector, or

a crushed coaxial cable—though it may also result from interactions of multiple different frequencies operating nearby.

- Interference caused by external sources, however, can come from just about anywhere: from other cell networks, radar, motors, spark plugs, nearby high-voltage lines and other sources.

Interference steals capacity from any given signal, so successful spectrum management depends on a low-interference RF path. Interference mitigation filters (IMFs) are small devices inserted into the RF path to allow only specific desired frequencies to pass through. IMFs can help mitigate interference in both the uplink and downlink, maximizing the potential throughput.

Multiplying challenges

In addition to simple physical problems in the RF path, PIM can also be caused by combining two or more frequencies that can multiply and create new interfering signals. These mathematical combinations of two or more frequencies—PIM products—can cause interference not only in their own band, but in multiples of that band, called second-order PIM, third-order PIM and so forth. Higher orders create less interference but cover a wider swath of spectrum. You can learn more about PIM in Chapter 7.

Planning a successful site upgrade

In order to avoid and overcome these challenges, it's important to consider many factors together when planning a site.

Antenna considerations:

- **Spectrum support.** Most antennas support more than a single band, so, when adding new spectrum support to an existing site, it is essential to identify a replacement antenna that will support both current and new frequencies. If you find one, ensure it supports enough transmit and receive paths. It is also essential to perform a PIM analysis that includes the existing as well as the new bands.
- **TDD or FDD?** As explained above, to maintain a duplex connection, the network must split the two directions either by separating them into two frequencies or creating a duplex connection via time division scheme. It is worth noting that TDD is not truly duplex, but only emulated via timed division of transmitting and receiving. Regulatory licenses will specify which method should be used.
- **Beamforming.** As networks deploy more sites and more antennas, there is a corresponding need to mitigate interference between sectors. Beamforming helps concentrate coverage and reduce overlap with adjacent cells.
- **Vertical vs. horizontal separation.** As we covered in Chapter 6, horizontal and vertical separation can help isolate antenna signals and avoid interference.

Other site logistics:

- **Sufficient power and backhaul.** Adding radios to support additional spectrum means the site will draw more power. Ensure there is adequate dc power available. Also, since more traffic will be using the RF path, it's critical to ensure adequate backhaul capacity—either by fiber-optic cable or microwave. We cover site power in Chapter 11 and backhaul in Chapter 9.
- **Weight and wind load.** Weight and wind load. Additional antennas, filters and radios needed to support new spectrum can add a great deal of weight to a cell tower, as well as introduce greater wind loads. These must be checked against specifications before deployment of additional tower-top infrastructure.
 - To reduce tower stresses, using diplexers and triplexers can reduce the number of cables needed to connect tower-mounted radios and the baseband equipment on the ground by allowing each one to carry more than one signal at a time.
 - At higher frequencies, tower-mounted amplifiers (TMAs) can overcome the uplink coaxial cable losses; however, being mounted atop the tower, they mean more weight and wind load to contend with.
 - New structural steel solutions can provide a more robust, rigid and durable mounting surface for additional components (see Figure 8.4).



8.4: CommScope's high-capacity sector frame, rated to hold 1,500 pounds of antennas and tower-top equipment

Adding small cell sites

With so much new spectrum available in the higher frequencies, there's no escaping the need to add more sites to increase network density, boost capacity and enable 5G networks. As discussed above, high-frequency signals are great for increasing capacity but are limited in terms of how far they efficiently propagate and what kind of obstacles they can work around. One solution, therefore, is to deploy large numbers of small sites in such a way that, together, they exploit the advantages of high-frequency spectrum without relying on large sectors to operate.

Typically, small cells operate in spectrum above 1700 MHz and cover limited and well-defined areas. Because their deployment scenarios can be so wildly varied, it's particularly important to consider the performance and capabilities available and match them to individual locations.

Another constant concern for small cell deployments is that of appearance. Zoning regulations vary from place to place—and balancing high performance with small size can be difficult. CommScope's Metro Cell solution (Figure 8.5) offers a wide variety of concealment options on a fully integrated small cell architecture that includes its own dc power supplies and backhaul solutions. We cover small cells in more detail in Chapter 13.

Downtilt or no downtilt?

Small cells may be available with adjustable downtilt capabilities that are helpful in avoiding interference with other sectors within the line of sight. However, in areas where small cells are isolated from line of sight by obstacles such as buildings or other structures, such a feature may not be necessary—reducing the site's cost.



8.5: CommScope's Metro Cell concealment solution, with multiple mounting options

For all wireless operators, small cells are a vital component to using spectrum in the higher frequency bands—exploiting the bands' strengths and mitigating their weaknesses. The use of higher-frequency bands will only increase as time goes on and 5G become a market reality.

Get the most from your spectrum

Available spectrum is scarce and getting scarcer, even as demand continues to rise. This means wireless operators must squeeze every last bit from their networks.

Managing spectrum starts with understanding it—how different bands offer unique advantages.

There is more than one way to acquire spectrum, but no easy ones. Whether won at auction for millions or billions of dollars, leased, or used in unlicensed bands, operators must ensure that every bit of spectrum they use is working its hardest and delivering the most revenue possible.

From SAS solutions that enable unlicensed CBRS access to small, flexible Metro Cell solutions that exploit the strengths of high-frequency spectrum, CommScope has long been at the forefront of the industry as a trusted partner with the technology and expertise to solve practical problems in a practical way.

Chapter 8 summary

Gaining spectrum

- Regulatory auctions
 - High prices, low availability
 - New 600 MHz bands repurposed from TV
 - CBRS and millimeter wave bands coming soon
- Bands can be bought from or swapped with other networks
- Unlicensed spectrum
 - Free to use but of limited utility
 - Wi-Fi not yet a reliable cellular alternative
- Infrastructure-level spectrum management
 - CBRS requires SAS to utilize
 - IMFs reduce interference
 - PIM is an internal and external challenge
 - Power, backhaul, weight and wind load considerations all affect how one adds spectrum
- Small cells
 - Great for high-frequency, short-distance cells
 - Must be tailored to suit unique environments

The infrastructure behind the call: Backhaul



Chapter 9

The infrastructure behind the call: Backhaul

Chapter 9

Backhaul

The process of connecting two ends of a transmission through a central routing point.

Imagine two kids, each standing in their own backyards, talking to each other on soup cans connected by a string. This is the simplest of connections: nothing more than two users on a direct, point-to-point, dedicated line. This same simplicity applies if we replace the cans with walkie-talkies—the communications system is still reliant on just two points of contact.

Once the system becomes more complex—like modern distributed communications networks with millions of users—these simple connections are no longer practical or possible. A centralized processing point is needed to route many conversations simultaneously just to make the correct phone ring when you dial its number.

This is the role of the core network behind hundreds of thousands of distributed cell sites. Of course, being orders of magnitude more complex, it requires a correspondingly robust infrastructure to move that much information up and down in a fraction of a second—allowing for smooth and natural communications even when the two ends are thousands of miles apart. “Backhaul” is the collective term for this part of the RF path.

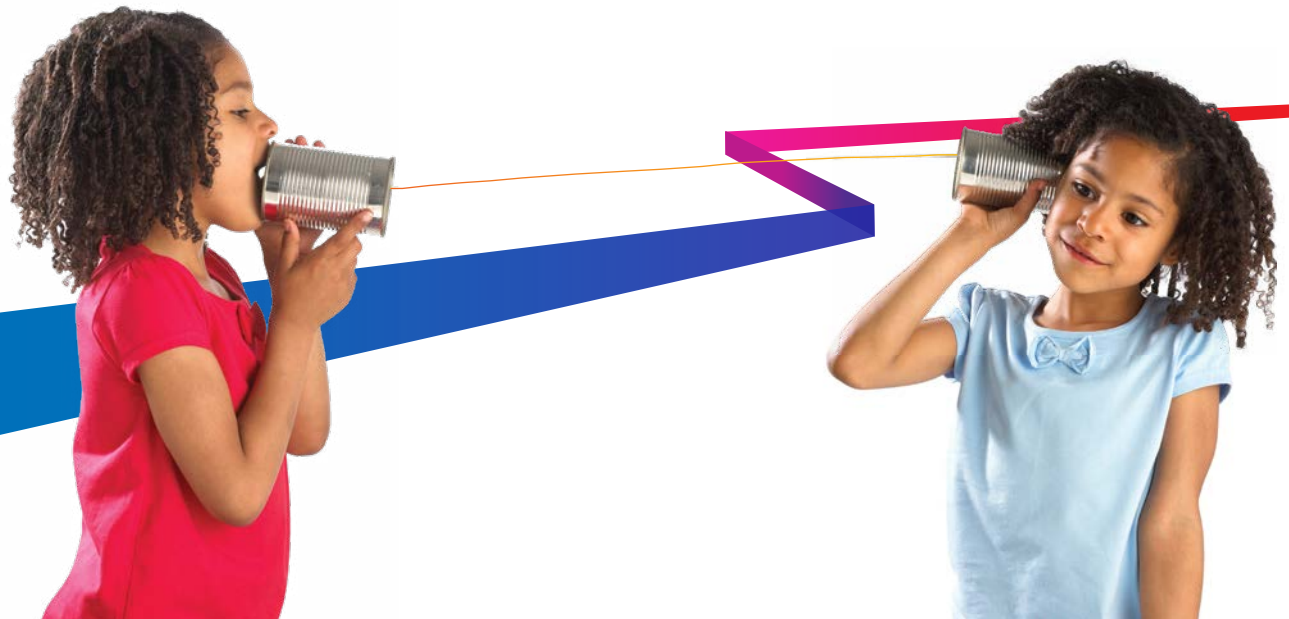

9 | The infrastructure behind the call: Backhaul

The process of routing network traffic for a cell phone call requires many steps to complete, and looks something like this:

1. Mary makes a call to Bill on her cell phone from her office
2. Mary's outbound call is picked up by the nearest cell tower
3. The tower routes Mary's call to the area's regional network
4. The regional network sends Mary's call to the national network
5. The national network routes Mary's call to Bill's regional network

6. The regional network broadcasts Mary's call from the nearest cell tower

7. Bill's cell phone rings, he answers, and the call connects

Backhaul is the process of routing Mary's cell call—along with thousands of other simultaneous connections—up and down from the core network. This includes steps 3, 4 and 5 in the example. Obviously, this kind of aggregated data requires high speed and high bandwidth in order to route connections, and there is more than one way to provide backhaul. The two most commonly-used forms of backhaul in modern cellular networks are fiber-optic backhaul and microwave backhaul—and each offers specific advantages for different kinds of installations, locations and requirements.

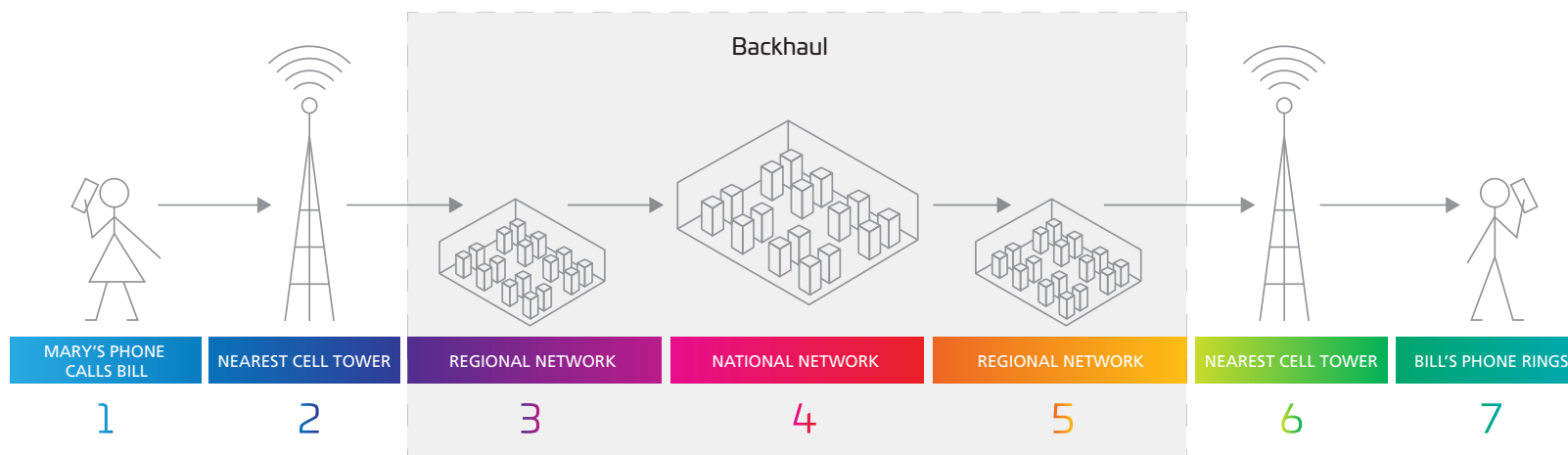

Fiber-optic backhaul

Fiber-optic backhaul uses high-speed, high-bandwidth, fiber-optic cable to move network traffic up and down the core network to individual cell sites where mobile users connect. Fiber-optic backhaul infrastructure allows the nearly-instantaneous movement of massive amounts of voice and data traffic over long distances. Like all fiber-optic infrastructure, it uses light pulses rather than electrical signals to move information. For this reason, it offers significant headroom and space to grow as new applications and cellular technologies come to market; its capacity can be magnified by a practice called “multiplexing,” which is the use of different wavelengths of light—different colors, essentially—to move multiple streams down the same fiber without interfering with each other.

This is particularly useful when trying to get more capacity from an existing fiber-optic installation without laying additional cable. All it takes is the right solutions to retrofit an existing cable, such as CommScope’s

passive wavelength division multiplexing (WDM) module. WDM combines and separates multiple wavelengths of light onto a single strand of fiber to create separate, independent pathways that increase the data-carrying capacity of the fiber cable.

The same WDM components can also be used to separate the wavelengths (de-multiplexing) at the remote location with these modules simply integrating into existing telecom equipment. It provides a simple and efficient solution to capacity shortages without any incremental power consumption expenses.

Wavelength division multiplexing (WDM)

The practice of sending multiple wavelengths of light down a single fiber-optic cable, making each fiber carry two or more parallel communications that are separated out at the other end.

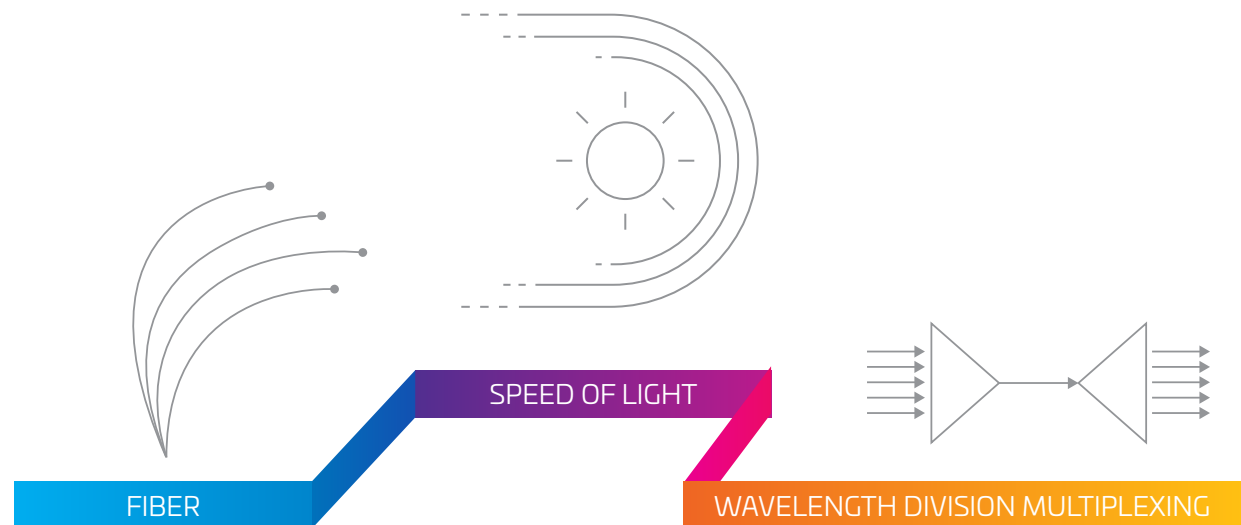

C-RAN: the evolutionary future of cellular networks

The incredible capacity of fiber-optic backhaul is driving another important trend in cellular architecture: C-RAN. C-RAN actually denotes two distinct but related concepts: *centralized* radio access networks and *cloud* radio access networks. The former lays the foundation for adoption of the latter.

The migration of cell site components from the base of the tower to the tower top to improve efficiency began with the movement of amplifiers and radios, with the baseband unit remaining at the bottom of the tower where it connects to the core network. The next phase of this evolution will see the movement of the baseband unit as well—not up the tower, but away from it. Thanks to fiber-optic efficiency and speed, the baseband unit can be located miles away, sharing space and processing power with other units from other sites—neatly collected into a shared central office space that's easier to maintain and more efficient to operate.

Essentially, we will see fiber-optic backhaul technologies employed to enable fronthaul in the RF path as well. This is the centralized version of C-RAN.



C-RAN

Two related cellular network architecture evolutions that are currently in development:

Centralized radio access networks use fiber-optic cable to relocate the baseband units to centralized, remote locations far from their towers and radios, using backhaul-style infrastructure to support fronthaul traffic between the radio and the baseband unit.

Cloud radio access networks replace the baseband units with virtualized baseband functions in a centralized location for even more efficiency and scalability.

9 | The infrastructure behind the call: Backhaul

Yet, as amazing as this evolution sounds, it is merely a prelude to something more incredible. With fiber-optic fronthaul connectivity established to remote sites, cloud-RAN replaces the physical baseband units altogether. More accurately, it replaces them with baseband functionality run in virtualized form in data center-style

environments—the shared resourcing that makes it a cloud-based solution (Figure 9.1). As this technology takes shape in the near future, it will offer cellular operators unprecedented flexibility, scalability and efficiency.

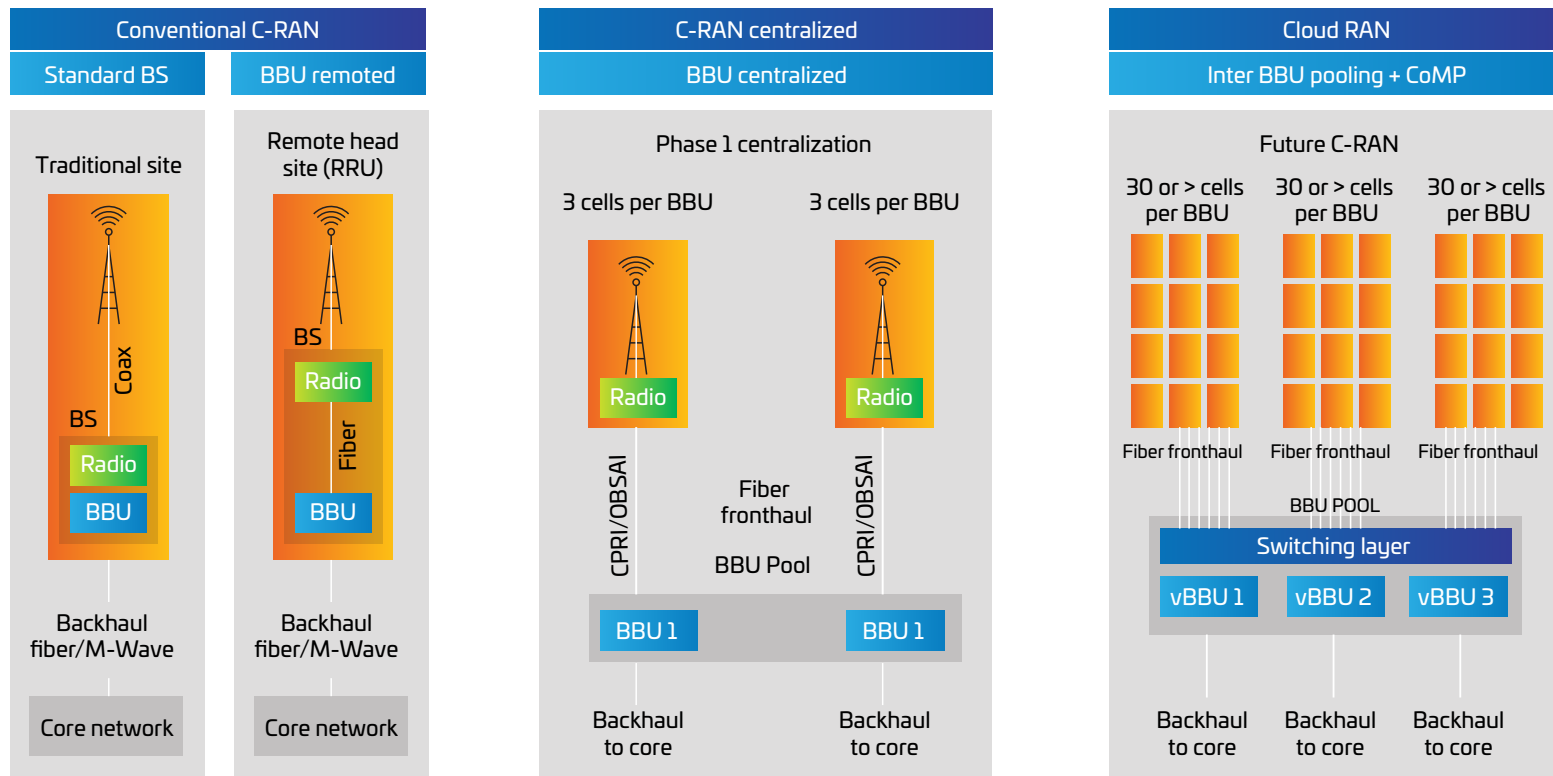

9.1: The evolution from RAN to centralized RAN to cloud RAN

Fiber isn't always the right solution

So, if fiber-optic backhaul is so fast and flexible, why isn't it the universal solution? The answer is that other factors, relating to economics and logistics, sometimes make fiber-optic backhaul impractical or even impossible for particular cell sites. Installation of underground fiber-optic backhaul can incur significant upfront costs in both time and money—two things that are always a premium for a growing cellular network.

In some locations, the ability of fiber-optic backhaul to maximize the critical revenue-earning potential of a cell site can justify these additional investments. Its greatest strategic advantage is in its vast capacity and, where it can be installed (or even connected to existing fiber-optic infrastructure, such as may be the case when a cell site is located on or adjacent to a fiber-connected building), it is considered the go-to solution. In other locations, however, it may simply be infeasible. In the next section, we will see how a complementary technology, microwave backhaul, also fills an important role.

Microwave backhaul

Microwave backhaul accomplishes the same function as fiber-optic backhaul, but without the fiber-optic cables. Instead, it utilizes a network of powerful and precise point-to-point microwave antennas to link cellular traffic between sites and the core network.

Microwaves comprise a discrete range of the electromagnetic spectrum of all types of radiation. Like other bands, microwaves are expressed in hertz (Hz), a measurement of a particular radiation's frequency. Most frequencies used in electronics are expressed in thousands of hertz, or kilohertz (KHz); millions of hertz, or megahertz (MHz); billions of hertz, gigahertz (GHz); or even trillions of hertz, terahertz (THz). Some of the more



Line of sight (LOS)

The unobstructed space between transmitter and receiver. Longer hops must even account for the obstructive effects of the Earth's curvature.

familiar types are listed below (Table 9.2). As you can see, microwaves are among the higher frequencies used in communications.

Microwave backhaul is an attractive alternative to fiber-optic backhaul when site locations are particularly remote or inaccessible—or where permits cannot be secured to lay fiber-optic infrastructure. It moves aggregated traffic from one antenna to the next, where it can be routed to a third, then a fourth or as many “hops” as it takes to reach the designated core network access.

Globally, around 65 percent of all mobile data traffic is transported using microwave backhaul at some point on its journey. In some cases, it may be a simple hop from the cell site to the nearest fiber access point.

These hops are also called “links,” and they can be many miles long. As a line-of-sight (LOS) solution, microwave backhaul antennas can direct a concentrated beam of information to a similar receiving antenna as long as there exists direct, unbroken clearance between the two antennas. For this reason, microwave antennas are mounted high enough on the tower to “see” their distant reception points.

Frequency band	Frequency (GHz)	Typical maximum hop length (km)	Typical minimum hop length (km)
0.9 (unlicensed)	0.902–0.928	100	–
2.4 (unlicensed)	2.4–2.5	100	–
4	3.6–4.2	70	24
5	4.4–5.0	60	16
5 (unlicensed)	5.3, 5.4 and 5.8	50	–
L6	5.925–6.425	50	16
U6	6.425–7.125	50	16
L7	7.1–7.75	50	10
U8	7.75–8.5	50	10
10	10–10.7	20	10
11	10.7–11.7	20	10
13	12.7–13.25	20	6
15	14.4–15.35	20	6
18	17.7–19.7	20	2
23	21.2–23.6	20	2
26	24.25–26.5	20	2
28	27.5–29.5	15	2
32	31.0–33.4	10	1.5
38	37.0–40.0	10	1
42	40.5–43.5	10	1
60 (unlicensed)	57.0–66.0	1	–
80	71–76/81–86/92–95	5	–

9.2: Typical hop lengths for microwave frequency bands

Microwave advantages

The microwave band possesses characteristics that make it a flexible solution lending itself to multiple environments:

- The low end of the band (below 11 GHz) propagates over long distances, ideal for long-haul connections to users in remote locations.
- The higher end of the band (above 11 GHz) propagates over shorter distances, ideal for short-haul connectivity required in urban locations.

In addition to their technical characteristics, microwave links also offer practical and financial advantages over cable solutions, which have made them a popular alternative for modern communications networks:

- They are less expensive to install than fiber-optic solutions, and less expensive to operate than copper-based backhaul infrastructure.
- They can be quickly deployed with less zoning and regulatory overhead than digging to install any kind of backhaul cable.
- Modern microwave backhaul solutions offer bandwidth that approaches that of fiber-optic backhaul—and far exceeds anything possible with earlier-generation copper infrastructure.
- They are scalable and highly reliable when quality antennas are properly installed.



Microwave backhaul in action

Let's revisit Mary's cell call to Bill in the example earlier in this chapter. Mary dials the call and the cell phone connects with the nearest cell tower, operating on the network's radio frequencies (within the 700–2700 MHz part of the spectrum). The cell tower hands off the call to a microwave transmitter (typically into one of the bands between 6–40 GHz), which directs it via its link to a collection or aggregation center, which, in turn, makes the connection to the mobile network's core network. The traffic is then routed across the network to the region closest to the receiver's location, to be transmitted again by microwave to the nearest cell tower.

The receiving cell tower station down-converts the microwave signal back to the network's radio frequencies for its final journey to the target cell phone. The process

Duplex communications

A transmitter and receiver that work in different time slots or frequency slots on the same device.

is reversed for traffic moving in the opposite direction. This two-way microwave backhaul generally uses a frequency-division duplex (FDD) system that allocates frequency channel pairs for simultaneous two-way, or duplex, communication (Figure 9.3).

Another way to achieve duplex communication is via a time-division duplex (TDD), which achieves the same goal by switching the required direction of transmission in a very fast, precise manner (Figure 9.4). While a more efficient option, TDD requires very careful timing control and is not the preferred system for microwave use.

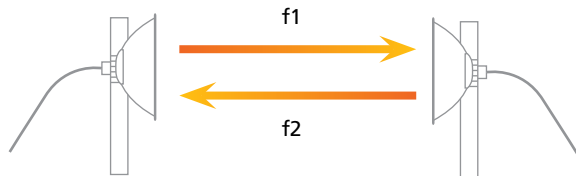

9.3: Frequency-division duplex (FDD) system with separate go/return frequencies

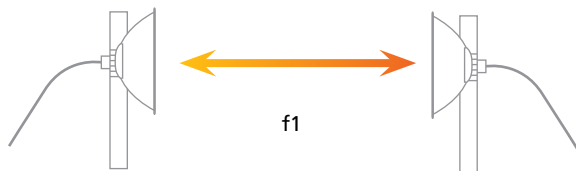

9.4: Time-division duplex (TDD) system using just one go/return frequency

Network capacity and managing demand

Simply put, capacity is a network's ability to handle transmission traffic. In the case of cell communications, this traffic means voice and data—often a great deal of data. As capacity demands continue to rise with the wide adoption of 4G/LTE devices all over the world, smart planning becomes even more important to assure headroom for tomorrow's data-hungry applications.

- **Modulation.** One way to boost capacity along a microwave link is called "modulation." By employing different modulation schemes, more traffic can be squeezed into the limited bandwidth available when needed. The tradeoff is that higher modulation schemes require higher signal-to-noise performance to maintain the integrity of the data—boosting power requirements and the associated operating costs. Modulation is also subject to environmental effects, which we will explore later in this chapter.
- **Adaptive modulation.** Recently, adaptive modulation has become a universally adopted technique to help operators balance traffic and reliability needs. Adaptive modulation scales the amount of signal modulation employed as a function of the link's condition—so, if rain or other factors are present, modulation is dialed down to maintain error-free, if somewhat slower, traffic rates. When the link condition improves, modulation is automatically increased to take advantage of prevailing conditions.

- **Co-channel dual-polar operation.** Another capacity-boosting technique leverages the polarization characteristics of microwaves themselves, which allow two streams of traffic to travel the same bandwidth at the same time—one vertically, one horizontally. This technique is called “co-channel dual-polar” (CCDP) operation. CCDP is often used in short-haul antenna systems where an integrated dual-polarized antenna is created using an ortho-mode transducer (OMT) to attach two ODU radios to a single antenna. This arrangement maintains a high level of isolation between the two signals for maximum clarity (Figure 9.5).

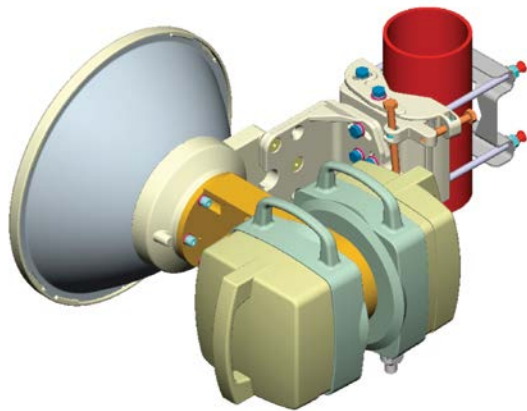

9.5: An example of an integrated dual-polarized antenna

Typical microwave deployments

For best LOS clearance, microwave antennas are often mounted on towers or at the top of high buildings. To maximize the value of these choice locations—and to reduce the costs for leasing these locations—microwave backhaul antennas are often mounted adjacent to base station antennas, which also rely on altitude for efficient operation (Figure 9.6).

Many short-haul installations, typically operating above 11 GHz, use a split-mount radio system, which divides the radio into an outdoor unit (ODU) and an indoor unit (IDU). The ODU houses the microwave circuitry, including

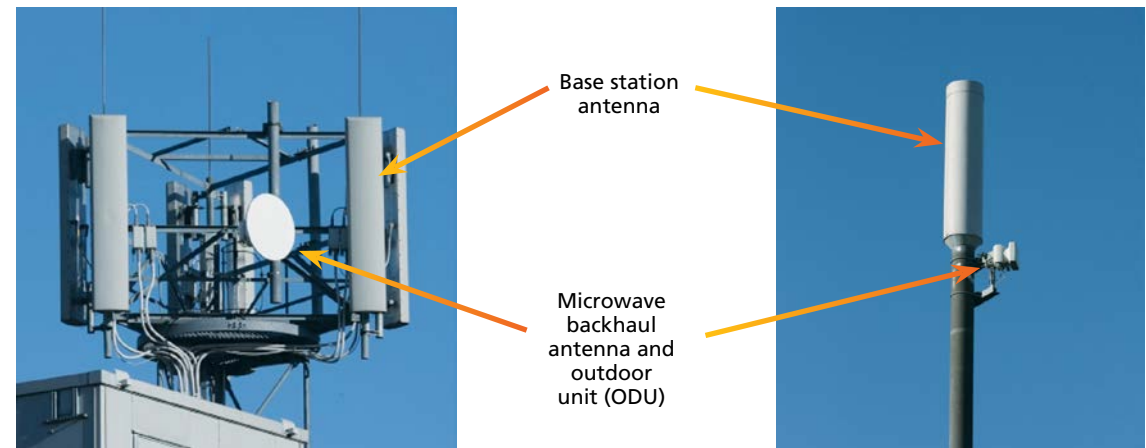

9.6: Typical microwave backhaul antenna integrated into a base station antenna location

the go/return microwave signal separating diplexer and the up/down frequency converters. It is mounted in an enclosure adjacent to the antenna—or more frequently integrated into the antenna assembly itself (Figure 9.7).

The IDU contains the modulator/demodulator—more commonly known as a modem—and the control circuitry necessary for translating the cell phone traffic into a form suitable for microwave transmission.

For high-density traffic and long-haul hops, multiple radios are typically housed in a remote radio room

adjacent to the base of the tower. Generally, these hops use larger antennas operating at frequencies under 11 GHz (Figure 9.8).

Connections between the antenna and the radios are made by coaxial cable or elliptical waveguide, depending on the frequencies involved (Figure 9.9). For tower-mounted outdoor radios, fiber-optic jumper cables carry the data stream straight to the radio on the back of the antenna.

Split-mount radio system

A two-stage connection that lets microwave radios located in an indoor unit (IDU) receive and transmit through an antenna fitted with an outdoor unit (ODU).

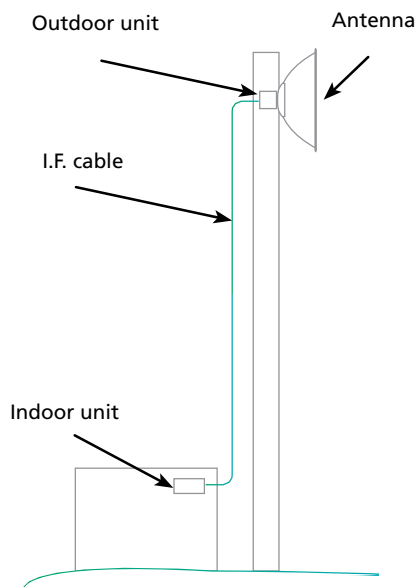

9.7: Typical split-mount microwave radio system showing IDU and ODU



9.8: A typical lower frequency aggregation point

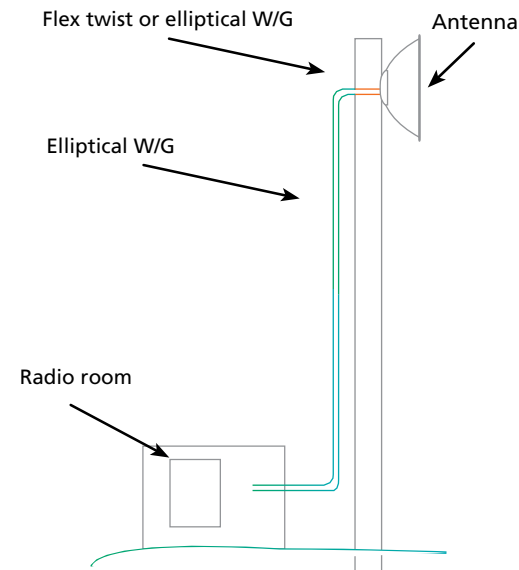

9.9: Connections between remote microwave radios and a microwave antenna

Planning a microwave link

When considering a new microwave backhaul path, interference is major concern. The planned link must not interfere with adjacent links or other operators in the area. To prevent conflicts and other problems, you must consider:

- Frequency coordination with other links in the vicinity
- Radio and radiation characteristics of the antenna
- Transmission power levels

To avoid these issues, industry standard software tools such as iQ-link® XG from CommScope can smooth the planning process and assist in regional overview. Antenna manufacturers offer assistance as well, providing planners with the radiation pattern envelope (RPE). An RPE document includes a performance summary and the key specifications related to antenna gain, beam width, cross-polar performance and radiation patterns (Figure 9.10).

The chart describes the directional properties of the antenna by mapping its directionality (in decibels) against its azimuth angle. As this chart shows, the envelope has a main beam area at zero degrees, corresponding to the electrical axis of the antenna. This is the line-of-sight direction, where the directionality is at its maximum.

Away from the main beam, the directionality quickly decreases. This corresponds to a drop-off in antenna

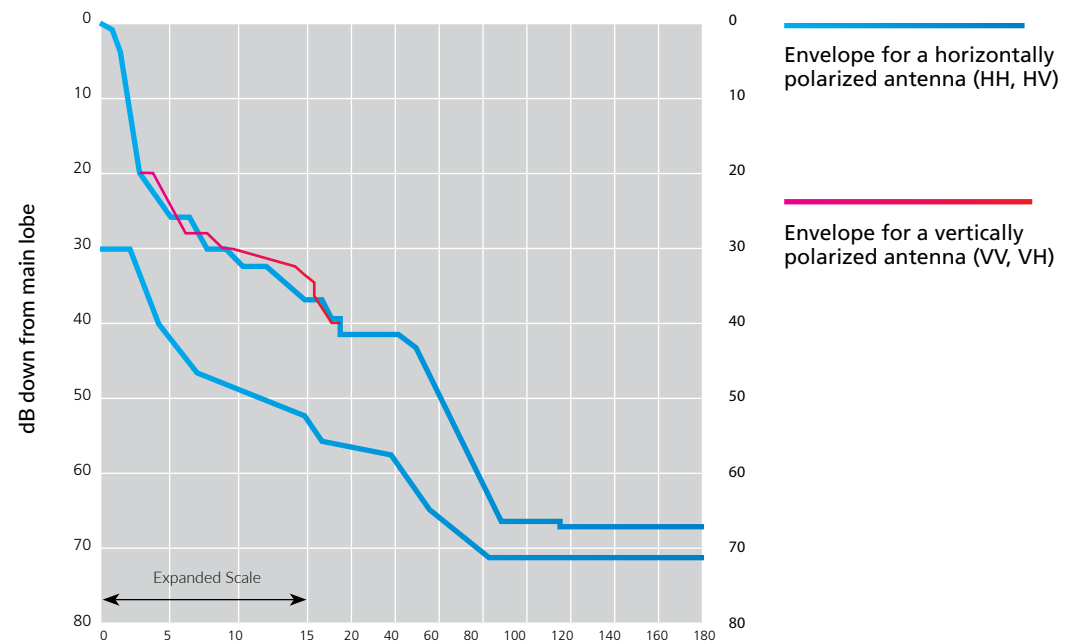

9.10: A typical radiation pattern envelope (RPE) document

sensitivity, whereby signals transmitted or received away from the on-axis direction reduce rapidly. The link planner uses this information to determine how much of their new proposed link signal will deviate from the intended direction and assess whether this is likely to present interference problems.

Because of their importance in the planning process, RPE documents are strictly regulated. In Europe, the European Telecommunications Standards Institute (ETSI) publishes several classes of envelope standards that all antennas

must satisfy. A Class 2 antenna may be permissible in locations where interference is not an issue, but cannot be used where a stricter Class 3 standard is required. Increasingly there is a trend to the more stringent Class 4 specification, which represents a significant advance over earlier standards.

Sidelobes, reuse, and the Class 4 advantage

Class 4 antennas feature lower sidelobes than Class 3 alternatives. This means more of their signal energy is directed at its target, and less of it “leaks” around the edges of the beam or behind the antenna. Simply put, it’s a metric of efficiency that allows a Class 4 antenna to support much higher link densities than a Class 3 antenna can (Figure 9.11).

Because their low sidelobes create so little interference, Class 4 antennas—for example, CommScope’s Sentinel® solution—can provide 40 percent greater spectrum reuse, essentially creating capacity simply by using available spectrum more efficiently. Where adaptive modulation is used in the radio it allows the radio to maintain the highest modulation states for longer in adverse conditions, maximizing capacity over the link.

Depending on the characteristics of the link and the unique low lobes, in certain circumstances, it may be possible to deploy a smaller diameter Class 4 antenna than would be needed if a Class 3 antenna were used—reducing tower loading and saving lease costs.

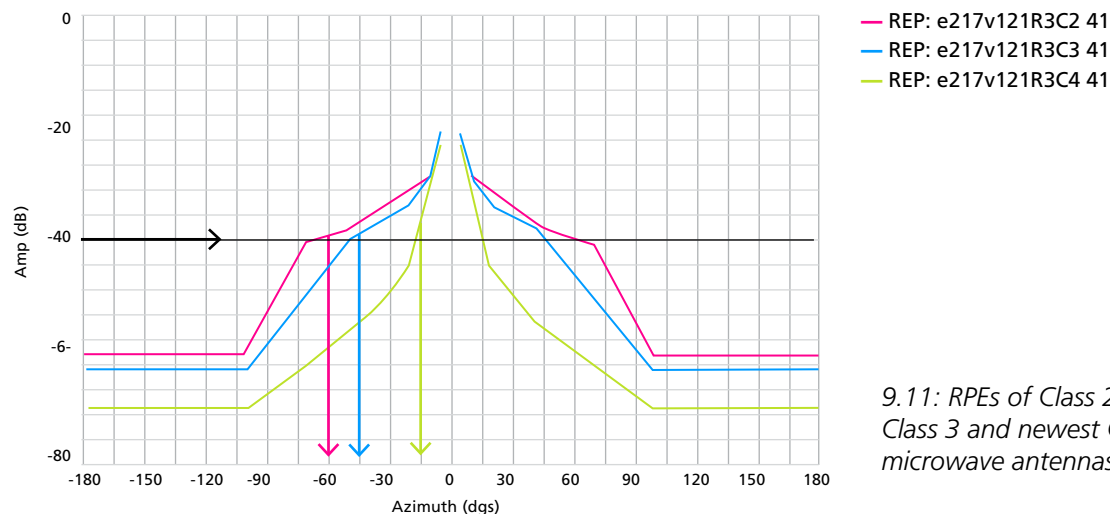

9.11: RPEs of Class 2, Class 3 and newest Class 4 microwave antennas

Protecting microwave systems from the elements

Like every stage in the chain of communication, backhaul must be reliable and available at all times. Downtime means lost revenues, irritated customers and expensive repairs. In practical terms, downtime is measured as a percentage, or in minutes per year (Table 9.12). A detailed explanation of reliability predictions and measurement can be found in Chapter 12.

Downtime, minutes per year	Availability
525.6	99.9000%
52.56	99.9900%
26.28	99.9950%
5.256	99.9990%

9.12: Downtime in minutes per year and corresponding availability percentages

Due to its open exposure to the elements, certain reliability-limiting factors are unavoidable:

- Precipitation and moisture
- High winds
- Temperature variances
- Lightning strikes
- Atmospheric refraction

Fortunately, each challenge to reliability has an available mitigating measure.

Rain and snow

As mentioned earlier, lower-frequency microwave bands propagate very well across long distances, allowing hops of 50 kilometers or more. In fact, the most significant limiting factor is not distance itself, but atmospheric conditions. Rain falling through the signal path reduces signal strength—an attenuating phenomenon known as “fade.”

In frequencies above 11 GHz, rain-induced attenuation becomes more pronounced, reducing hop distances accordingly. Rain—and, to a lesser extent, snow—can scatter signals in these frequencies. The impact depends on the rate of precipitation, the frequency involved and the signal polarization (the orientation of the signal wave, which may be horizontal or vertical).

Horizontal signals are more adversely affected by rainfall due to the shape of raindrops as they fall, so vertical polarization is the preferred choice for any link planning. Fortunately, it is possible to mitigate these effects based on the calculations of rain outage models, building a safety margin into the transmission’s power levels to compensate for expected loss and assure a reliable hop between stations. Modern microwave radios will even adjust power on the fly when needed, using an automatic transmission power control (ATPC) system.

Precipitation also interferes with polarized transmissions through an effect called “polarization rotation,” which

Signal polarization

The orientation of a signal’s electric field relative to the ground. It may be horizontal or vertical.

Automatic transmission power control (ATPC)

A system that dynamically raises transmission power to overcome the effects of interference.



essentially turns a signal's polarity enough to interfere with other signals. To counter this effect, a cross-polar interference canceller (XPIC) samples signals in both polarities in order to produce a wave that cancels out the interfering, "rotated" part of the signal.

Adaptive modulation

Another technique gaining widespread acceptance in microwave backhaul applications is called "adaptive modulation." In addition to compressing, or modulating, network traffic into smaller bandwidths at higher signal

levels, adaptive modulation adjusts the amount of modulation in response to any link impediments. The result is that adaptive modulation can dynamically reduce traffic to compensate for the impaired signal level while still maintaining the link, albeit with lower capacity.

Mitigation methods can also be built into link designs themselves. In multiple-hop situations, mesh and ring topologies provide alternative signal paths that bypass problematic hops by rerouting around them. Path selection is dynamic and adapts on the fly to changing conditions (Figure 9.13).

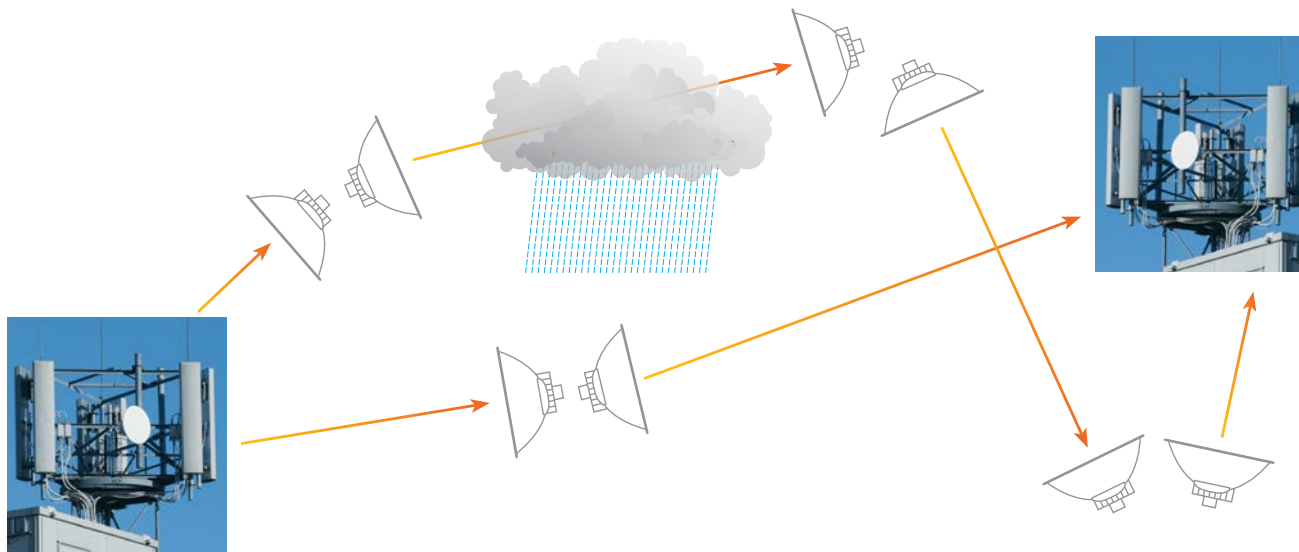

9.13: Network topology with dynamic routing paths

Fog

Fog presents a challenge only to the highest microwave bands above 60 GHz. Unlike rain, snow and other precipitation, it presents no real obstacle to lower, more commonly used microwave frequencies.

Temperature

By itself, temperature has little effect on microwave signals. However, if water vapor is present in transmission lines, it can condense there and impede performance when the temperature drops. The effect is similar to the attenuation caused by rain.

Snow and ice accumulation

Antennas must be designed to withstand accumulations of snow and ice without deflecting or becoming misaligned. Fabric radomes on long-haul antennas prevent ice buildup in the signal path itself; however, antennas are still vulnerable to damage from ice falling from higher up the tower. Ice shields fitted above the antenna offer robust, low-cost protection.

Wind load

The force of wind on an antenna can present a serious threat to tower-mounted equipment. Wind speeds rise with altitude, so a breeze at ground level can become a gale at the top of a tall tower or building. This is why

antennas are designed to ensure mechanical integrity under all anticipated environmental conditions—up to their survival rating, which, at minimum, would be 200 km/h (125 mph) and often 250 km/h (155 mph), such as with CommScope's Class 3 ValuLine® antennas and Class 4 Sentinel antennas.

Below their ultimate survival wind speed, antennas have an operational limit. This relates the allowed deflection of the antenna under wind loading to the beam width of the antenna. This ensures that, up to the operational wind speed, link performance can be maintained.

Lightning strikes

Installed in open, unobstructed locations, microwave antenna towers are natural targets for lightning strikes. If a strike passed through the antenna itself, serious damage to sensitive components would result. To avoid this danger, low-resistance earth-paths—in effect, lightning rods—are installed to direct lightning strikes away from critical components. For a full exploration of how to guard against lightning, see Chapter 14.

Radome

A wind- and water-proofed fabric or plastic cover that protects an antenna from the elements.



9.14: Ice accumulation on a radome-protected installation

Atmospheric effects

Atmospheric effects can disrupt reception, particularly for lower-frequency signals. Under some circumstances, a signal may essentially be received twice—first by its intended LOS connection and then again as a slightly delayed echo of itself as a result of atmospheric refraction or ground reflection. The tiny timing difference can mean the signal arrives out of phase, in effect interfering with itself. This effect is known as “multipath fading” or “dispersive fading,” as illustrated at the right (Figure 9.15). There are several ways to deal with this challenge.

- **Option 1: Space diversity.** To counter the effects of dispersive fading, we can add a second, uncorrelated parallel microwave transmission path, separated vertically (Figure 9.16) or horizontally. This separation is called “space diversity.”

Because the two paths don’t share exactly the same space, their signals don’t encounter exactly the same fading effects. The practical result is that the receiver has the option of accepting its signal from the path that happens to be less disrupted at the time.

- **Option 2: Frequency diversity.** Frequency diversity is another means of combating atmospheric or dispersive signal loss. A secondary, standby channel operates at a different frequency from the main channel. Since different frequencies propagate differently, two signals of different frequencies don’t experience the same attenuation—doubling the chances of clear reception.

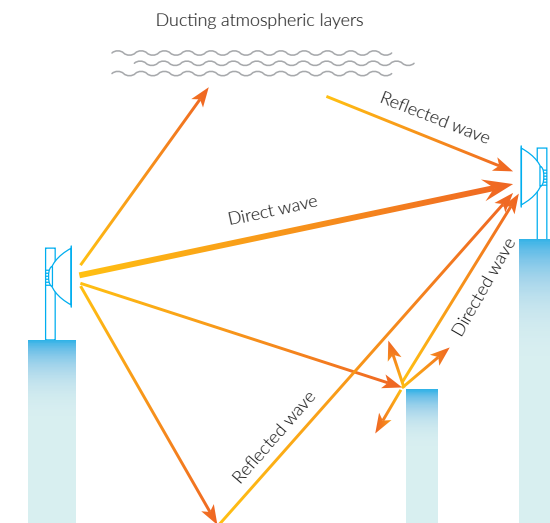

9.15: Dispersive fading creating out-of-phase signal echoes—delayed signals bounce off the ground and vertical obstacles, and also refract in the atmosphere



9.16: A typical vertical space diversity arrangement

Flat fading

Flat fading is another atmospheric hazard for low-frequency signals. Unlike dispersive fading, the entire channel is attenuated because refraction has disrupted the link's LOS connection, so it misses the receiver entirely. A second, uncorrelated microwave path or increased power via ATPC can counter this effect.

The importance of compliance

Some of the reliability-limiting factors can be avoided by using standards-compliant antennas from a reputable manufacturer. With the pressure to minimize total cost of ownership, it is tempting to purchase the lowest price antenna option, but you must also consider ongoing operations expenses in budget calculations. An inexpensive install may end up costing far more than a more expensive antenna with better characteristics for your application.

Noncompliant antennas are not identified simply by cheaper prices. They also include design problems that can spell trouble from day one (Figure 9.17). Generally, they may be:

- Untested and feature nonrepeatable designs
- Prone to deteriorate too quickly, resulting in RF leakage, moisture ingress and metallic components degradation
- Used with third-party add-ons for normal operation, which introduce new opportunities for corrosion, vibration and other loss of integrity.



9.17: Example of RF leakage in a noncompliant microwave antenna

Flat fading

Total signal loss caused by atmospheric refraction. It is the result of a signal being bent completely out of its LOS connection with its receiver.

The hidden costs

CommScope recently conducted a study to measure the cost and benefits of using lower-quality, noncompliant antennas. In this study, we examined three types in the 15, 18 and 23 GHz bands. In actual operation, the true costs began to emerge:

- Network failure of 19 percent in the 15 GHz band
- Network failure of 29 percent in the 18 GHz band
- Network failure of 21 percent in the 23 GHz band

Obviously, these failure rates are unacceptable to most modern applications. Choosing a compliant antenna—even a more expensive one—offers benefits that can save money and hassles once the antennas are in operation, such as reduced interference, longer links, reduced tower weight and wind loads, more capacity and more efficient spectrum reuse. These benefits are all particularly pronounced in ETSI Class 4 solutions such as CommScope's Sentinel solutions.

To ensure your microwave antenna meets specifications—and your backhaul network will therefore perform as expected—there are a few common-sense steps you can take to avoid noncompliant antennas and assure your network's availability and reliability.

1. Take advantage of your supplier's resources to demonstrate structural integrity under all anticipated environmental conditions.
2. Review the supplier's antenna interface design data and test range facilities for each integration type.
3. Avoid third-party add-ons that don't qualify at the integration level; the third-party supplier won't have this information, but your antenna supplier should.

This basic due diligence will pay off in reliability, speed and total cost of ownership over the long term.



The techniques of tomorrow

In addition to C-RAN possibilities made possible by high-performance fiber-optic and microwave backhaul technologies deployed today, there are other exciting technologies in the mix for the future. Non-line-of-sight (NLOS) schemes using unlicensed bands offer one method of small-cell backhaul, allowing signals to turn corners and avoid obstacles in urban environments, where LOS systems aren't as effective as they are in the open.

The deployment of E-band spectrum (71–76 GHz and 81–86 GHz) has opened new avenues for high-capacity microwave backhaul. Operating under varying licensing regimes (depending on the country deployed), very wide channel assignments ($n \times 250$ MHz) are available to operators—making multi-Gbps data rates a real possibility. Combining E-band technology with conventional lower frequency microwave bands into a dual-band solution can provide very high-capacity, reliable links over a significant range.

There may also be promise in the recently-opened 60 GHz unlicensed band. At such high frequencies, the oxygen in the air itself can absorb signal power, so this band is suitable only for short links—often less than a single kilometer in length. While this may seem like a

limitation rather than an advantage, urban environments benefit from this short-link option because they offer high data traffic rates and have such limited ability to interfere with one another from one pico- or micro-cell to another.

With so many advances in recent years—and so many still to come—this is truly an exciting time in communications.

Backhaul makes modern communications possible

The ever-increasing complexity of modern communications networks demands more efficient and innovative ways of managing backhaul. Both fiber-optic and microwave technologies offer solutions with exceptional capacity, speed and reliability—with the decision between them for any given site resting largely on location and logistics.

Backhaul is evolving to embrace fronthaul functionality as centralized RAN gains adoption, and will support the cloud RAN deployments of the near future. This can be achieved mainly through fiber but also through high-capacity microwave.

At the same time, microwave backhaul is evolving to meet higher standards—with lower sidelobes, tighter RPEs and better interference discrimination. This maximizes the uses of existing spectrum and

allows ever denser networks to be deployed. Plus, the availability of new spectrum for use in these applications means microwave backhaul will only grow as a useful backhaul technology for the latest generation of cellular communications.

The key takeaway is that fiber-optic and microwave backhaul solutions are complementary, not competitive, technologies. Any large-scale network will need to employ both—fiber-optic for its vast capacity, and microwave for its flexibility in remote or cost-limited areas. Together, they can provide the wide pipeline needed by today's most advanced wireless networks.

Chapter 9 summary

- Backhaul moves traffic on and off the core network
- This is most commonly accomplished with fiber-optic cable or microwave antennas
- Fiber-optic alternatives are efficient and open the door for new architectures
- Centralized RAN uses fiber-optic cable to move baseband units from sites to a shared central location
- Cloud RAN will virtualize baseband functions in data centers for even more flexibility and efficiency
- Microwave antennas use LOS to link sites to the core network affordably and flexibly
- To overcome environmental challenges, there are many practices and solutions available for microwave backhaul antennas
- Class 4 options offer improved efficiency, capacity and reliability
- Noncompliant antennas are subject to reduced performance and more interference
- New microwave technologies are emerging to expand backhaul capacities

The next RF architecture evolution: C-RAN

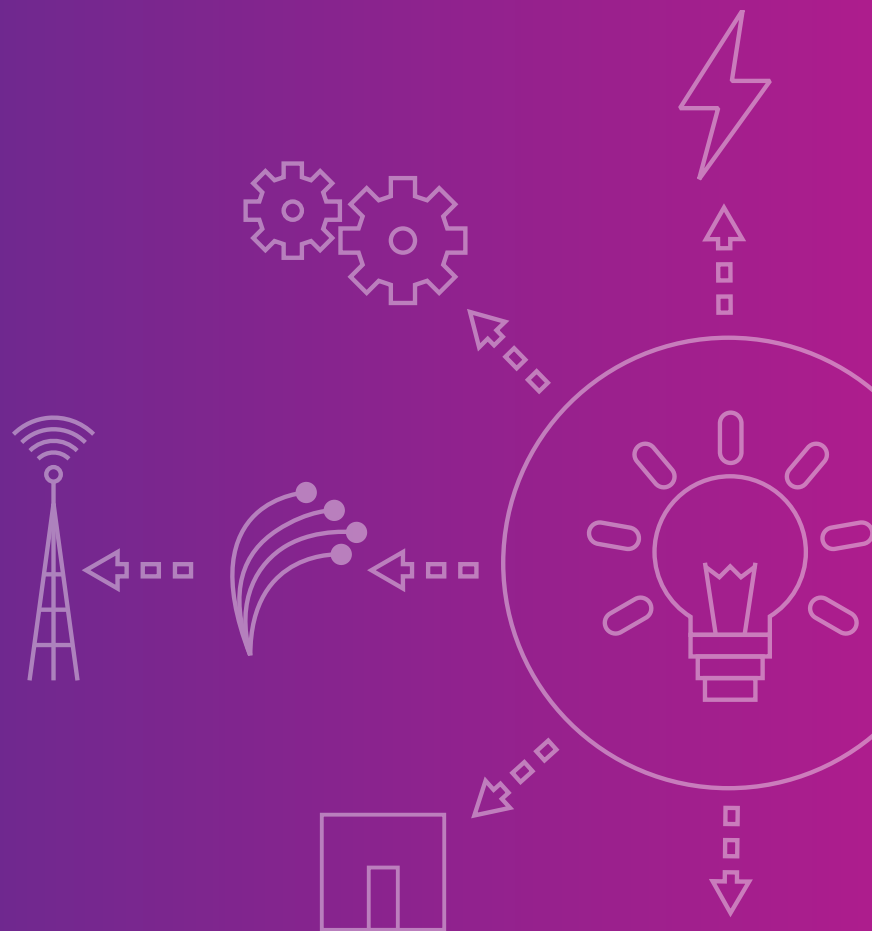

Chapter 10

The next RF architecture evolution: C-RAN

Many recent RF network innovations and advances are described in this eBook. Most relate to more efficient transport of signal and/or power; improved deployment strategies to increase coverage and capacity; or evolving business practices that make it practical to expand the RF network in a cost-effective manner. However, there is another innovation that is poised to completely revolutionize the very architecture of RF networks themselves—C-RAN, or centralized radio access networks. We discussed C-RAN briefly in Chapter 9, but now we can dig more deeply as C-RAN is the focus of this chapter.

Centralized radio access networks (C-RAN)

A wireless network architecture that separates a site's antenna and radio from its baseband unit (BBU) functions by centralizing many sites' BBUs at a single, centralized location connected predominantly via fiber-optic fronthaul.

Centralized Radio Access Networks (C-RAN)

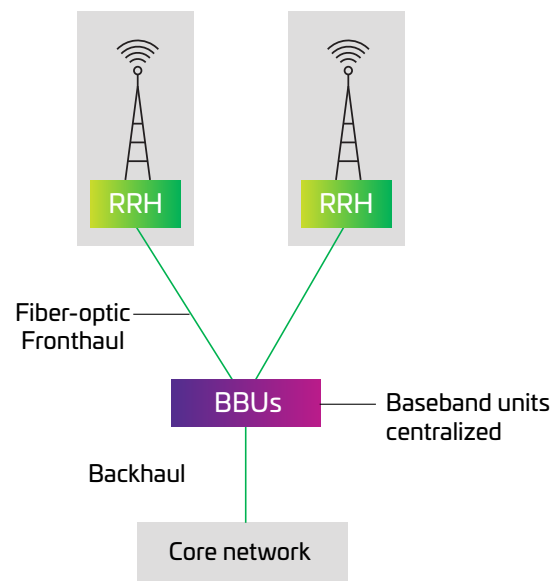

What is C-RAN?

To define what C-RAN is, it will be helpful to first define the conventional architecture of RF networks and then show how C-RAN changes that model. We can also look ahead to the next stage beyond centralized radio access

networks into the emerging realities of cloud radio access networks—which, confusingly enough, are also known by the shorthand term “C-RAN.” The distinctions will soon be clear (Figure 10.1).

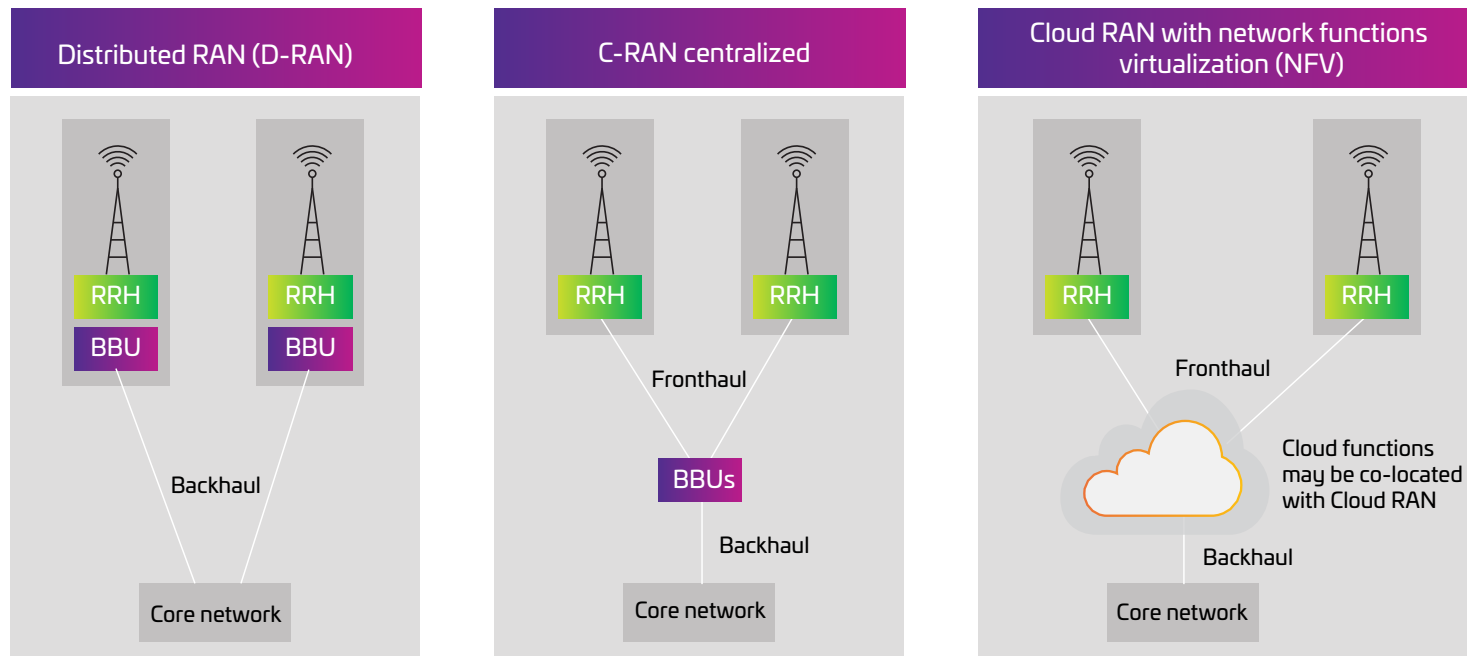

10.1: A simple comparison of the architectures of distributed RAN, centralized RAN and cloud RAN

- **Distributed radio access networks (D-RAN)** are what most would consider “normal” RF networks in the context of contemporary cellular technology. This architecture is explained in various ways throughout this eBook but, in general, it includes cellular sites that contain antennas and radios that connect to baseband units (BBUs) located at the cell site. Those BBUs then connect to the core network via fiber-optic or microwave radio backhaul—allowing traffic to switch and move freely from any point on the network to any other point.
- **Centralized RAN (C-RAN)** changes this layout by removing the baseband processing from the individual cellular sites and locating it remotely. The antenna and radio remain at the site, but now transport their signals via fiber-optic fronthaul to these remote baseband units. The reason for this is that a wireless operator can co-locate baseband units from many sites in a single, centralized location (Figure 10.1). This offers cost savings and also makes them easier to maintain and more efficient to operate. These centralized baseband sites are then connected back into the network core via fiber or microwave backhaul connections.
- **Cloud RAN (also C-RAN)** is the ultimate end game of C-RAN. This is when some network functions start being virtualized in “the cloud.” Once the BBUs are centralized, commercial off-the-shelf servers can handle much of the routine processing. This means the BBUs can be redesigned and scaled back to focus on the complex or proprietary processing. Centralizing base station processing with cloud-based RAN simplifies network management and enables resource pooling and coordination of radio resources.



10 | The next RF architecture evolution: C-RAN

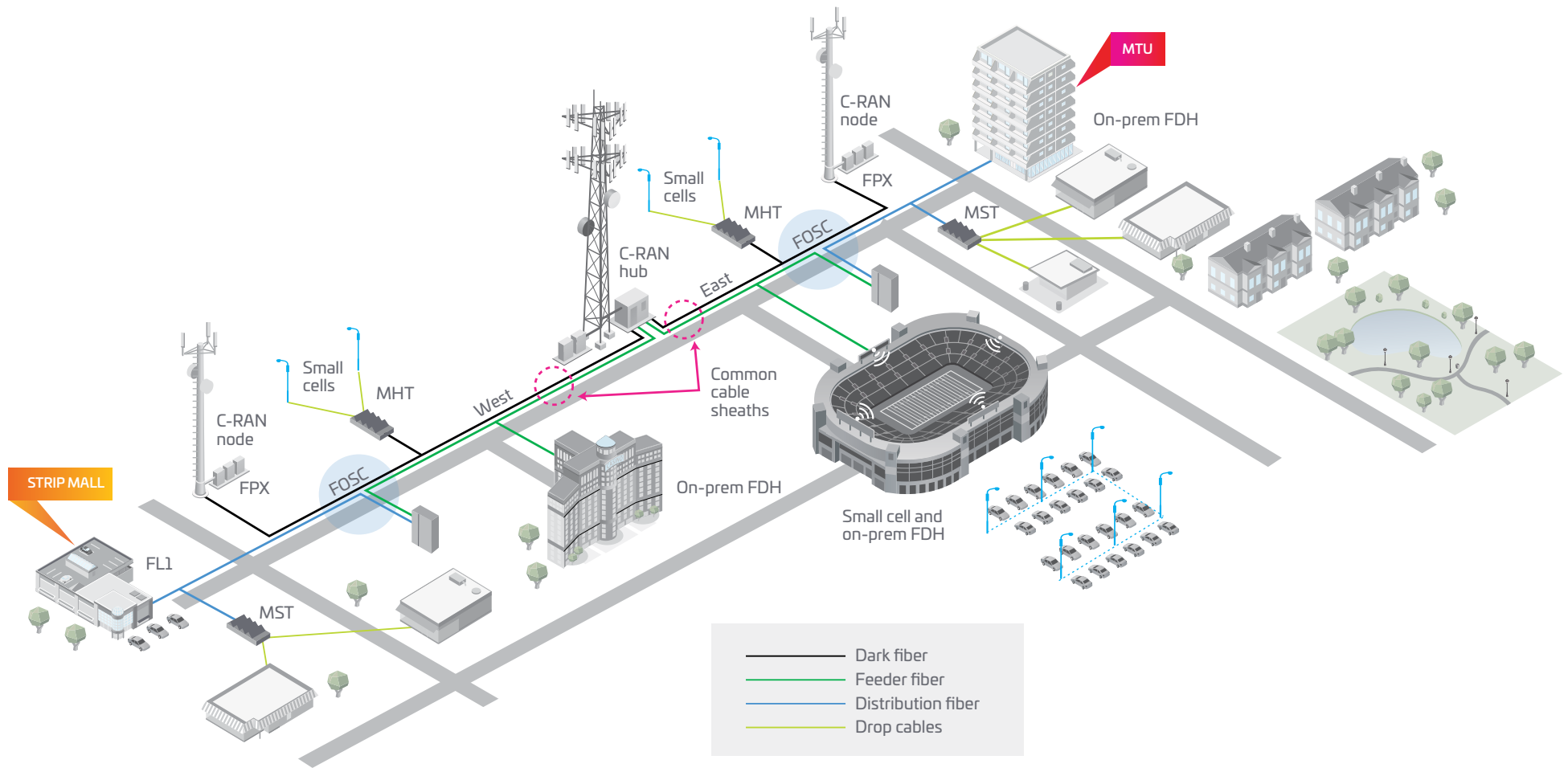

10.2: A single centralized RAN hub (center) manages traffic from multiple locations scattered across a city

Key advantages of C-RAN: efficiency and performance

Centralized RAN is an attractive network architecture for wireless operators for several good reasons, all related to the performance of the network and the cost of operating that network.

• Efficiency

C-RAN deployments mean less equipment is required at individual cell sites. In addition to saving on hardware costs, the C-RAN model can create significant savings in terms of power, cooling and site leasing costs.

By locating BBUs in a single, secure and controllable location, operators both improve their CapEx costs and can better control ongoing OpEx, as well, due to reduced space leasing costs and power consumption.

After all, it's intuitively true that it's more cost-efficient to maintain a pool of BBU hardware in one location than to service them spread across dozens or hundreds of distributed sites.

• Performance

C-RAN also offers wireless operators a significant advantage in terms of how their network's capacity is utilized. Because BBU functions are pooled in a single location, it becomes possible for them to share and balance traffic loads across the network. As demand shifts from one location to another, BBUs can help each other process the load, ensuring that operators are getting the best performance (and value) from their infrastructure.

It also allows for multiple cell sites to handle the same signal at the same time—"repurposing" the interference that would normally result from this into improved signal and greater capacity. This is called advanced coordinated multipoint (CoMP) transmission and reception.

Advanced coordinated multipoint (CoMP) transmission and reception

All cellular networks face the challenge of interference that occurs in the overlapping areas of coverage between two sites. In C-RAN deployments, it's possible to pool signals from multiple antennas to create additional capacity where interference would otherwise occur. This is done via a complex software algorithm.

Such an operation requires the extremely low latency times afforded by high-speed fiber-optic fronthaul infrastructure.



COST

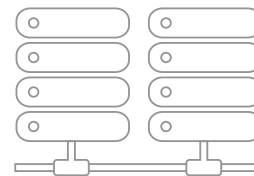

POOLING

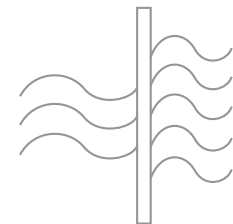

REPURPOSING

Why C-RAN—and why now?

Centralized RAN is an evolution that arrives just in time for the burgeoning wireless industry. Operators face tremendous cost pressures as average revenue per user (ARPU) shrinks year after year while demand for capacity continues to skyrocket. With few options to increase subscriber revenue, operators must look to reduced costs as the main vehicle to improve profitability. In Asia, the first region to successfully deploy C-RAN commercially, operators have seen operating expenditures (OpEx) drop by 30 to 50 percent.

Current trends point to increased utilization of C-RAN as operators densify their networks and roll out small cells—especially in densely-populated areas that need them. These are also among the most heavily regulated in their zoning laws, and aesthetics often work against an ideal deployment strategy.

The emergence of 5G networks will compound this challenge, as it relies upon a greater number of small sites to provide optimal bandwidth and speed. 5G also requires fiber-optic fronthaul and its low latency in order to fulfill its potential as the ultimate enabler of the internet of things (IoT) and all the connected services and devices that entails, including fleets of autonomous vehicles, smart cities and more. 5G will accelerate centralized RAN into the cloud RAN phase because of the enormous demand for efficient capacity it will impose.

Operating in the green

Another aspect driving increased adoption of centralized RAN architecture is the environmental benefit of its lower overall power consumption profile. While reduced energy use naturally improves an operator's OpEx picture, it can also help those operators meet internal or mandated energy efficiency targets and other environmentally-based goals.

- Centralization of BBUs and sharing of baseband processing means fewer BBUs are required, and their centralized location requires less air conditioning than a comparable number of BBUs distributed among individual cellular sites.
- C-RAN also makes it easier for operators to deploy smaller, more zoning-friendly sites that operate on lower power than large macro sites.
- Once cloud RAN becomes more common, it will allow operators to scale back BBU processes even further during periods of lowest demand, such as in the overnight hours—reducing power consumption even more.

Blurring of networks— and expectations

Modern wireless subscribers see little distinction between the networks they use at home, in the office, and on their mobile devices. They expect a seamless and speedy internet onramp from their phones as much as from their laptops and desktops.

**C-RAN helps make
this possible.**

The challenges of C-RAN

As with every innovation described in this eBook, centralized RAN faces some considerable challenges in its deployment as a practical solution. None are insurmountable, but they can alter the calculus involved in deciding where and when to deploy C-RAN architecture in a wireless network.



Fiber-optic fronthaul requirements

Owing to the enormous amount of bandwidth required by current-generation LTE networks—to speak nothing of emerging 5G networks—the fiber-optic fronthaul infrastructure linking a site's radios to the remote BBU must meet high performance standards. With LTE, 10 Gbps speed is required, along with extremely low latency time. For many operators, this means adding or upgrading existing fiber-optic installations and investment in fiber infrastructure.

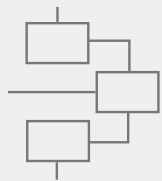

Reliable baseband interconnectivity

Because C-RAN concentrates BBU locations, it can also create a point of vulnerability in the network. In the event a BBU unit (or multiple BBU units) fails, the C-RAN hub itself must be equipped with a high-speed, low-latency fiber-optic switching infrastructure. Without this foundation, a failure in one unit could not be efficiently compensated by other units. It's also important that the hub's switching network provide the flexibility and scalability to grow and adapt as the network's needs change over time.



Advanced coordinated multipoint (CoMP) transmission and reception

Described above as a means to reduce interference between cells and improve network capacity, CoMP requires an advanced interface between BBUs and the capacity to jointly schedule radio resources. The real-time cooperative processing involved requires virtualized BBUs interfaced with adequate speed and latency in order to process the channel information and end-user data needed to make the solution work. It also requires a correspondingly fast and low-latency backhaul solution on the other side of the baseband processing.



Hub locations

Finding the best location to place a C-RAN hub is a balancing act for network operators. Placing it closer to the core enables them to consolidate a larger number of sites in one location, but placing it closer to the edge could allow the operator to better utilize and repurpose existing facilities. Often, though, the ideal location may be difficult or impossible to secure—particularly in denser, more urban environments.

C-RAN as an in-building wireless solution

Centralized RAN has wireless applications beyond its obvious benefit to the macro network. Wireless operators, neutral hosts, and even enterprise owners/managers have access to C-RAN-based in-building wireless solutions. As they do on the macro level, C-RAN IBW solutions make a strong case based on their improved economics, reduced complexity and increased capacity.

CommScope offers two such solutions: the OneCell® C-RAN small cell solution, and the Era™ C-RAN antenna

system, which is analogous in many ways to established distributed antenna systems (DAS).

Both OneCell and Era support current-generation LTE networks and provide a scalable onramp for emerging 5G technologies. They also both offer the significant cost advantage of operating exclusively on economical IT infrastructure—the ordinary copper and fiber-optic cabling used in buildings all over the world. This makes OneCell and Era both affordable to deploy, and simple to manage.

OneCell® small cell

Consisting of a baseband controller and multiple radio points, OneCell employs cloud RAN architecture to virtualize all cells within its coverage area, such as an office building or other large venue. By creating one vast, virtualized “super cell,” OneCell actually eliminates cell boundaries and the interference that occurs there. The result is clearer calls, faster data rates, and overall more consistent service in the covered building.



Era™ C-RAN antenna system

Era evolves the concept of DAS into the C-RAN age by allowing coverage of multiple indoor, outdoor and mixed spaces from a single, streamlined headend. All-digital fronthaul simplifies infrastructure and allows the BBU to be located anywhere on the premises—or even off-premises, if required. This opens up the possibility of virtualized cloud RAN processing in a remote hub. Era can balance capacity across the network as needed.



Welcome to the age of C-RAN

C-RAN is among the most exciting developments in the wireless industry over the past 20 years. It represents a radical, fundamental re-imagining of the way wireless networks are designed and built—a necessity considering how we are constantly re-imagining what we expect our wireless networks to do.

Both in its centralized- and cloud-based incarnations, C-RAN will answer operators' calls for a more efficient, more powerful network at a time when subscriber expectations far exceed their potential incremental revenue value.

In this way, C-RAN represents a fundamental change to the business model of the wireless industry as it does to its architecture.

C-RAN is indeed the network of the future—and it's already here.



Chapter 10 summary

- Centralized RAN: Pooling BBUs in central locations connected on fronthaul via high-speed, low-latency fiber
- Cloud RAN: Virtualizing BBU functionality in the cloud, allowing virtualization of BBU operations
- Co-located BBUs are more efficient to operate, cool and maintain
- Benefits include greater efficiency and load sharing, as well as the possibility of improved user QoS
- Challenges to C-RAN deployment include fiber fronthaul capacity; hub location and infrastructure; and advanced CoMP interfaces

The energy of communications: Powering wireless networks

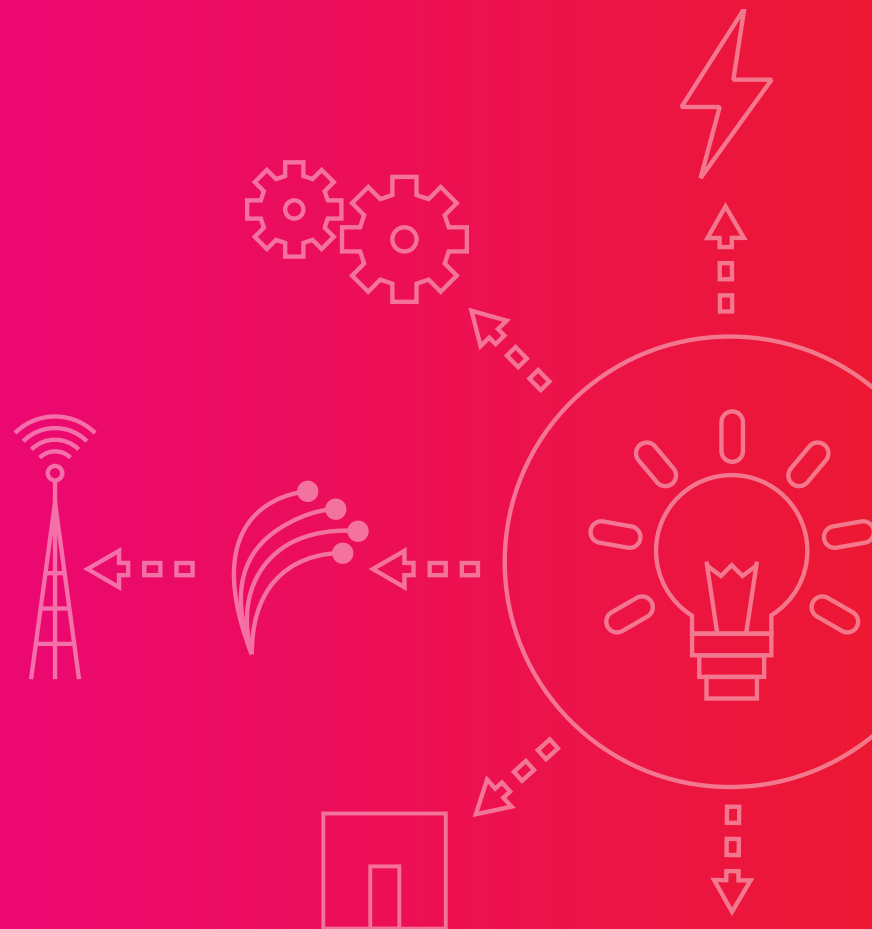

Chapter 11

Every year, our reliance on always-on technology grows. We expect to be able to place a call or surf the internet with our cell phones at any time, under any circumstances. However, the electrical infrastructure that powers our networks has not kept pace with the explosive growth of cellular access—and certainly hasn't kept pace with our expectations of 24/7 availability.

In previous chapters, we have explored some of the intricate and complex ways different components in a cellular base station come together to work efficiently and reliably. So far, the idea of powering these stations has been taken for granted. In real life, however, we don't have this luxury. Power supply connection is a very real challenge, and planning for the inevitable outages and interruptions is critical to keeping the network operating—no matter what complications may arise.

As wireless technology evolves, new and different powering architectures have emerged. In this chapter, we will study three aspects of powering wireless networks.

- 1. Macro site power**, including all the components and processes involved in operating a conventional cell site's equipment
- 2. Metro site power**, which distributes power to small cell sites in hard-to-connect areas with precise voltage requirements
- 3. Distributed antenna system (DAS) power**, which drives indoor coverage and capacity solutions across a discrete area

The first topic is the largest, both literally and figuratively, so let's see what it takes to power a conventional site.

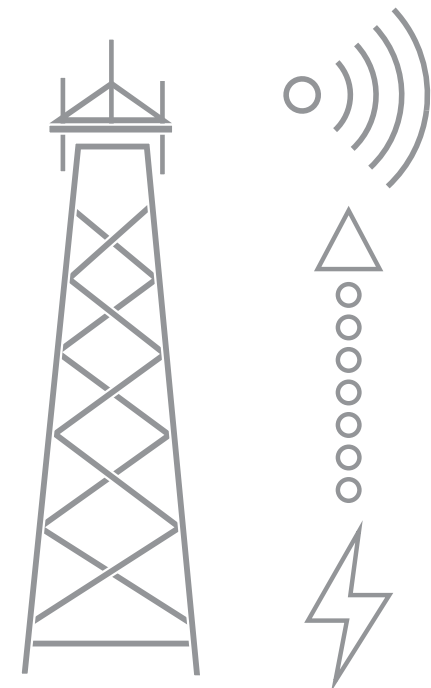

Macro site power

Power types—dc vs. ac

The core technology that drives modern communications runs on direct current (dc) electricity. This is different from the alternating current (ac) we use in our homes and offices. Since electrical power sent across transmission lines from power plants is ac, a device called a rectifier is needed to convert the ac current to dc before it can be used by the communications equipment.

The rectifiers' output is connected to both the radio and its transmission equipment—the “load” for the current—as well as the backup battery equipment (Figure 11.1).

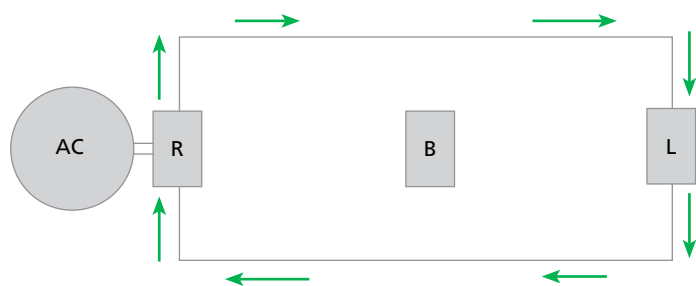

11.1: Basic power system diagram—arrows indicate the dc current's direction

Why go to the extra trouble of converting ac to dc? There are several reasons. First, most communications equipment includes semiconductors and other integrated circuitry that are designed to operate specifically with dc, such as:

- Telephone switches
- Microwave transmitters
- Fiber-optic transmitters
- Mobile radio and cellular systems

Another reason dc power is preferred for communications systems is its reliability advantage. Even the most advanced electrical grid can fail from time to time, and no one is immune to the possibility of power interruptions that may last for hours or days. When the outage occurs at a cell station, shutting down is not an option. So, battery backups are installed to allow continuous operation—and these power sources produce dc power.

Volt (V)

A measurement of electric potential difference between two points in a path. Voltage is sometimes referred to as “pressure” because it shares many characteristics with pressure in a water pipe.

Direct current (dc)

An electrical current that runs continuously in a single direction, making it well suited for use in motors and electronic components such as semiconductors. Batteries also produce dc current.

Alternating current (ac)

An electrical current that changes polarity (direction) 50 to 60 times per second. It offers significant efficiencies when transmitted across power lines—making it the standard current for household use.

dc power by the numbers

Communication equipment requires specific voltages of dc current. Most commonly, the requirements are positive 24 volts (+24 V) and negative 48 volts (−48 V). The higher −48 V value reduces associated current—and lighter current requirements allow for smaller and less expensive fuses, circuit breakers and cables. As a consequence, −48 V is rapidly becoming the dominant power supply voltage value.

Going beyond the basics

As mentioned above, the basic core components of a communication system’s power connection are the rectifier, which converts ac current to usable dc current, and the batteries that assume the load when external power is interrupted. Once dc is online, however, we must consider the specific power needs, or loads, of different equipment. We need a means to distribute the correct voltages to each piece of equipment.

To make these adjustments, devices called “dc-dc converters” can modify the primary dc voltage to suit the needs of a piece of equipment that demands a different voltage. In the event that some equipment requires ac current, we can also include a device called an “inverter,” which changes dc back into ac. Because this all takes

place behind the station’s main rectifier, this reconverted ac power isn’t subject to interruptions from the external power supply. A sample diagram showing all these components appears below (Figure 11.2).

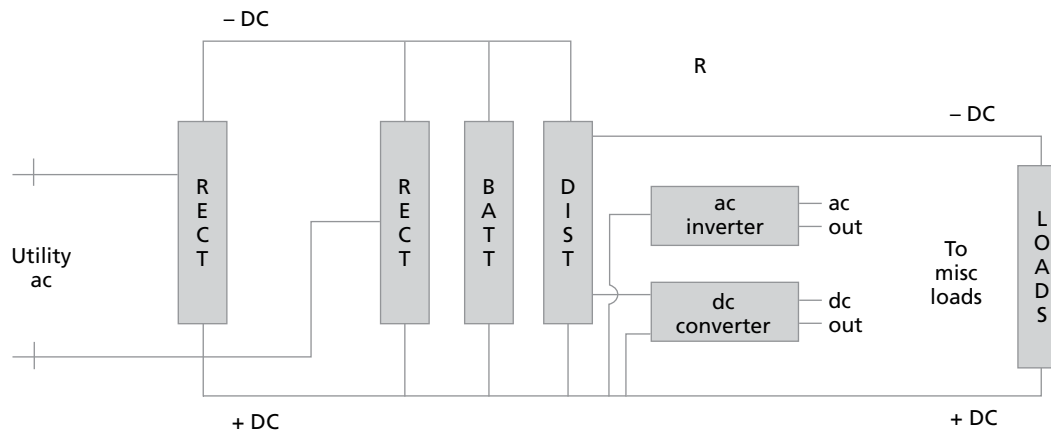

11.2: A block diagram of a basic telecommunications power system

The chemistry of batteries

At its most basic, a battery is an electro-chemical method of storing and releasing electrical energy. A battery contains chemicals that react with one another, producing dc electrical current as a byproduct. The specific chemicals and processes may vary—we will examine some common varieties below—but, on a fundamental level, all batteries operate on this core principle.

Battery backup times usually range from two to eight hours, depending on the load. Since telecommunications providers must be able to specify expected operational times, choosing the best type and configuration of batteries is critical.

- **Lead-acid batteries**

These are commonly used as backups for telecom power systems. They are compact relative to their output and are similar to the kind you would find under the hood of your car. They are available in vented and valve-regulated forms (Figure 11.3).

- **Vented** (also known as **wet** or flooded) **batteries**

These are a mainstay of telecom central offices and switching centers. They maintain a charge for up to 20 years or longer. However, they demand a great deal of costly maintenance such as water treatment, spill containment and

forced-air ventilation. These drawbacks make them less suited to remote cell base stations.

- **Valve-regulated lead acid batteries (VRLAs)**

These are recombinant batteries, which means oxygen and hydrogen can recombine to prevent water loss. Because they don't need added water, these are called sealed lead-acid batteries. They are easier to ship, maintain and install, making them the preferred choice for cell site base station use.



Flooded battery



VRLA battery

11.3: Vented (flooded) and valve-regulated lead acid (VRLA) batteries

Lithium ion batteries

These batteries are relatively new for wireless telecom applications. Unlike VRLA batteries, which are composed of four 12 VDC batteries per string, lithium ion batteries are packaged in a single rack-mounted module that provides -48 VDC output (Figure 11.4). These batteries are highly compact (50 percent the volume of a comparable VRLA battery).

The arrangement of these batteries in series determines the voltage polarity. If each of the 12 V batteries shown above is rated for 100 amp-hours, then each series string of batteries could be expected to produce 100 amps of current for one hour. Capacity is directly related to the size of the battery; but, rather than spending more on larger batteries, we can achieve the same boost to capacity by adding more strings of batteries to the system in parallel as opposed to adding them in series. This option also provides safeguards against the failure

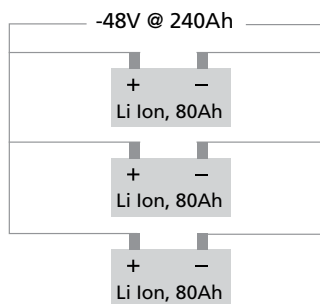

11.4: VRLA lithium ion batteries configured in series for -48 V applications

of an individual battery, which would remove its string from the system altogether. By connecting in parallel, the spare capacity is already online and ready to maintain the current for its rated length of time. A diagram of sample parallel battery strings rated at 240 amp-hours appears below. Note that, if a battery failed in any of the three series strings, the remaining two strings would continue to supply steady power at 160 amp-hours (Figure 11.5).

This configuration also provides a convenient means of maintaining the batteries. Often, these strings will be installed with separate disconnection breakers—making it easier to locate failures and isolate problems that could otherwise cripple the entire system.

Lithium ion batteries are packaged in rack-mounted -48 VDC modules in parallel. Should an individual module fail, the remaining modules will continue to provide backup power.

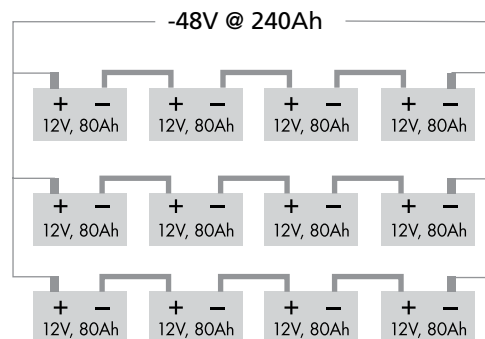

11.5: A VRLA multi-string battery configuration offering additional redundancy

Voltage polarity: positive (+) and negative (-) voltage

The + and - designations of +24 V and -48 V refer to which polarity of the battery circuit is measured; in terms of actual power produced, the distinction is meaningless.

Generators: the first line of defense

If batteries are the last line of defense against service interruption, generators are the first. Since batteries alone can maintain operations for only a few hours, longer ac service interruptions require a longer-term solution—and that means generating our own power. Unlike batteries, generators provide power by burning fuel. Like batteries, there are different types and configurations available. Which one you install depends on factors like space, cost and service expectations.

Since they operate outside the cell station's internal dc system, generators aren't considered part of that system. Because they supply the dc system's rectifiers with the ac they need, however, they're a vital link in assuring reliable operation. In the event the station must switch from external power to generator-supplied ac power, an electrical device called a "transfer switch" shunts the load to the generator, such as the one shown in Figure 11.6.



11.6: ac permanent generator

Rectifiers: the ac-dc interface

Once beyond the external source of power—whether it's commercial ac electrical service or an ac generator—the rectifier is the core of the system's dc power distribution needs.

The rectifier is designed to provide an output dc voltage level that maintains the battery charge. This level is called "float voltage," and it supplies the equipment load as well as a trickle charge to the battery. In the event of an ac power interruption, the rectifiers go offline and the batteries automatically kick in—providing the same level

of power to the rest of the system. When external ac power is restored, the rectifiers re-engage, and the batteries return to their trickle-charging state (Figure 11.7).

In practical deployments, multiple rectifier modules are usually required to supply power for the station's load. Rectifier modules are connected in parallel, letting each one share an equal part of the load—a practice known as "load sharing." With load sharing, operators can design in a degree of redundancy to guard against individual rectifier module failures.

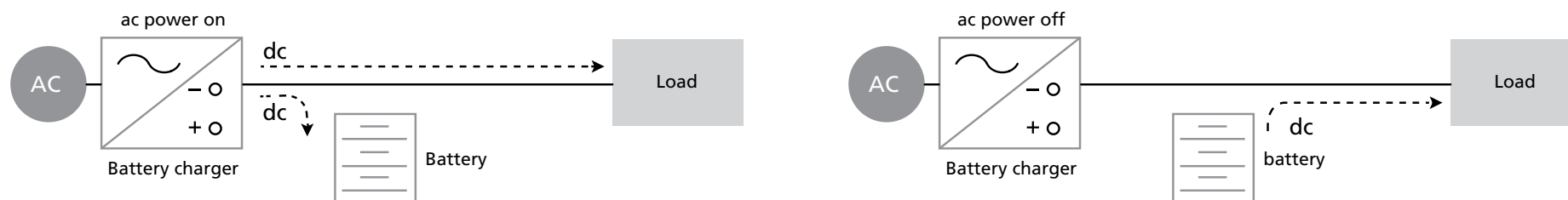

11.7: External ac power on (float mode) and off (discharge mode)

Choosing the right rectifier

The first consideration in deciding which rectifier will best suit a given installation is the kind of ac power it will receive. Switchmode rectifiers are the preferred choice for cell and microwave sites since they can support multiple ac inputs and have a broader operating range—from single-phase to three-phase inputs. This flexibility means fewer rectifiers are required—saving money, space and maintenance.



83A switchmode
6.3H x 3.4W x 11.8D

11.8: A typical switchmode rectifier

Distributing the power

The rectifier is merely the first stage in the dc power system. Once converted, the power must be distributed to the many component loads within the system. As mentioned above, these loads include core elements like the radio, transmitter and battery backup, but they can also include secondary systems like lighting, security networks and HVAC systems (Figure 11.9). In the most complex installations there may be so many components that up to 80 circuit breakers are required to manage them.

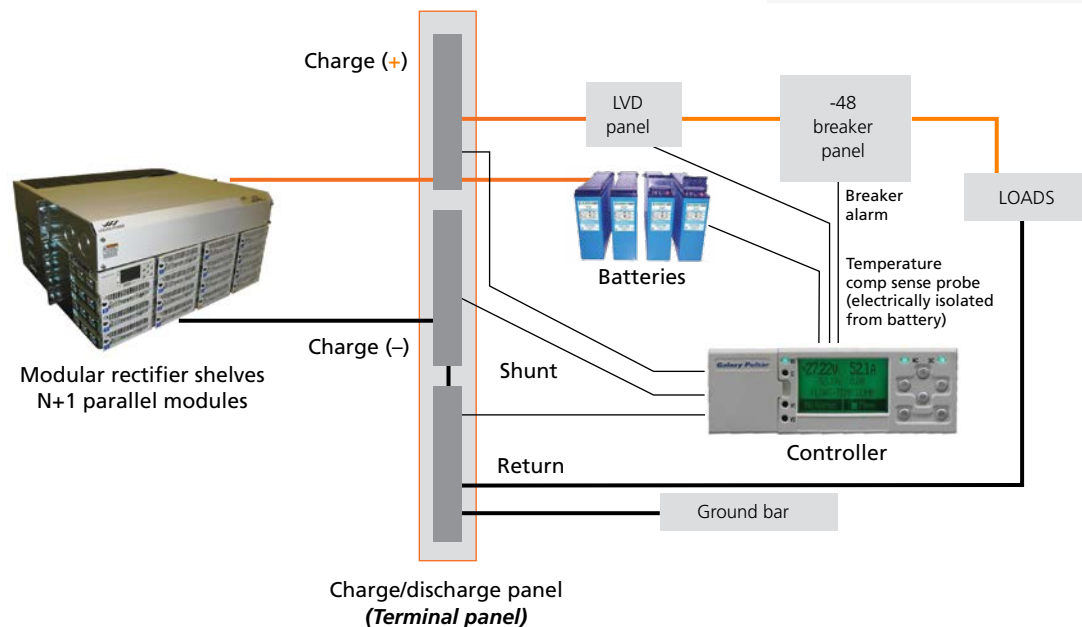

11.9: A diagram of a typical -48 VDC power distribution system (Images and illustration courtesy of GE)

How redundancy adds up to reliability

For a -48 V application with 200 amps of load, an operator may choose to install five 50-amp rectifiers. Why add a fifth, when four would provide the requisite 200 amps?

To ensure N+1 redundancy. Arranging multiple rectifiers in parallel allows load sharing to even out and shift the load.

Fuses vs. circuit breakers

While both fuses and breakers provide overcurrent protection, they do it in different ways. Fuses are designed to melt under unsafe currents—physically breaking the connection between the power source and the load. Circuit breakers have internal switches that pop to the “off” position under unsafe conditions—again providing a physical break in the circuit.

Sensitive wireless equipment requires “fast blow” fuses or short delay curve breakers to provide the needed protection. Fuses are generally used for lower loads and offer the advantages of lower cost, greater flexibility and fast action. Circuit breakers are preferred for larger loads and do not require replacement every time they are tripped. Some typical examples are shown (Figure 11.10).



11.10: Common types of telecom fuses and circuit breakers

Surge protection

Typical variations in ac power are not the only threat to a cell site. Electrical events like lightning can also produce excessive voltages and currents—events known as “electrical surges.” Surge protection devices (SPDs) are incorporated to reduce the effects of these surges on sensitive electronics (Figure 11.11).

An SPD features a non-linear voltage-current characteristic that reduces unsafe voltages by increasing the conducted current. In this case, a cell site’s SPD operates on the same principle as a surge protector does in your home—safeguarding expensive electronics from lightning-induced surges.



11.11: Typical surge protector devices (SPDs) (image courtesy of Raycap Corporation)

Bus bar conductors

The cell site's distribution system is supported by the bus bar conductors, which physically connect the rectifiers to the batteries and dc loads. There are two bus bar connectors: the **charge bus** and **battery return bus**.

- The **charge bus** is a current-carrying conductor that connects the rectifier's output to the battery string. For instance, in a -48 V system the negative rectifier lead would terminate on the charge bus along with the corresponding negative lead of the battery.
- The **battery return bus** provides a common return point for the loads connected to the power system. This common point is grounded to provide a low-impedance path for transients and noise and offers a ground reference to all connected equipment.

Battery disconnects

Battery disconnects are switches installed on a battery string that allow easy disconnection for maintenance or replacement. Some disconnects incorporate safety measures such as overcurrent fusing or breakers.

Load disconnects

Low-voltage disconnects (LVDs) are designed to respond to low-voltage conditions in the circuit. Low-voltage load disconnects (LVLDs) can disconnect individual loads, while

low-voltage battery disconnects (LVBDs) can disconnect a fully discharged battery. LVDs serve three main protective functions:

1. They prevent damage to sensitive electronics caused by low-voltage (and hence, high-current) conditions
2. They prevent permanent damage to the battery from over-discharging
3. They prioritize which components are disconnected, and in which order—preserving limited function when necessary

Supervision, monitoring and control

Modern telecommunication power plants are equipped with electronic monitoring and control systems, generally called controllers. They keep track of system voltages, currents, temperatures and other key indicators. They also allow operators to make adjustments from a central monitoring point—usually on the power plant itself, on the distribution cabinet or in a rectifier slot (Figure 11.12).

- **Plant control.** Control functions are extended from the supervisory panel to control other power system components. These panels communicate directly with the rectifiers and, in some cases, can coordinate the sequenced restart of all rectifiers to prevent power surges during switchovers from external ac to a backup power source.

- **Manual equalizing.** This allows a user to engage all rectifiers in equalize mode at once. This is useful for maintenance on VRLA batteries—equalizing cell voltage within a battery string.
- **High-voltage shutdown/overvoltage protection (HSVD/OVP).** Controllers can automatically shut down rectifiers when dc output overvoltage conditions are detected—avoiding costly damage to load components.
- **Low-voltage disconnect (LVD).** If a low-voltage condition is detected in the backup batteries, the controller can open additional contacts to equalize voltage and close them again when levels equalize.
- **Battery temperature compensation.** The controller can adjust rectifier output to meet the temperature-driven voltage needs of the batteries.
- **Charge current control.** This feature limits the current flow to a battery when it begins recharging after a power interruption. By keeping the battery from recharging too quickly, it prevents overheating and prolongs life.
- **Battery diagnostics.** The controller can estimate the “health” of the battery and predict how long it will provide power based on its charge status.
- **Alarm monitoring.** The controller monitors critical functions like distribution and battery fuse alarms, rectifier failures, converter failures and so forth. It

reports these alarms by way of network backhaul interfaces and LED indicators. Some units include audible alarms as well.

- **Status monitoring.** The controller can measure and compare the battery charge to the system load via an external shunt.
- **Plant history.** Controllers can log power system details over a span of time, including such statistics as thermal performance of outdoor enclosures, battery cell states, or variations in ac input experienced by the rectifiers.



11.12: A system controller interface displaying voltage, amperage and alerts

dc-dc power conversion

Some wireless sites require multiple dc voltage outputs, such as +24 VDC and –48 VDC. One solution is to install a second rectifier plant—but doing so comes with the burden of including a second battery backup array as well, which consumes considerable space and adds cost.

Another solution is to use a dc-dc converter system, an electronic power conversion device that changes a dc input voltage to a different dc output voltage. Below, you can see where a dc-dc converter system is connected in series between the main dc power system and the site's load (Figure 11.13).

A dc-dc converter system actually consists of multiple dc-dc converters arranged in parallel. It may also incorporate many of the same functions as the primary dc power system, such as distribution. It also has dedicated fuses or circuit breakers isolating it from the rest of the system.

Since a dc-dc converter system does not have an associated battery connected to its output, it isn't bound by a battery system's requirement for precise output voltage. However, since it is necessarily energized by the primary dc power system, that demand must be figured into the power system's initial design.

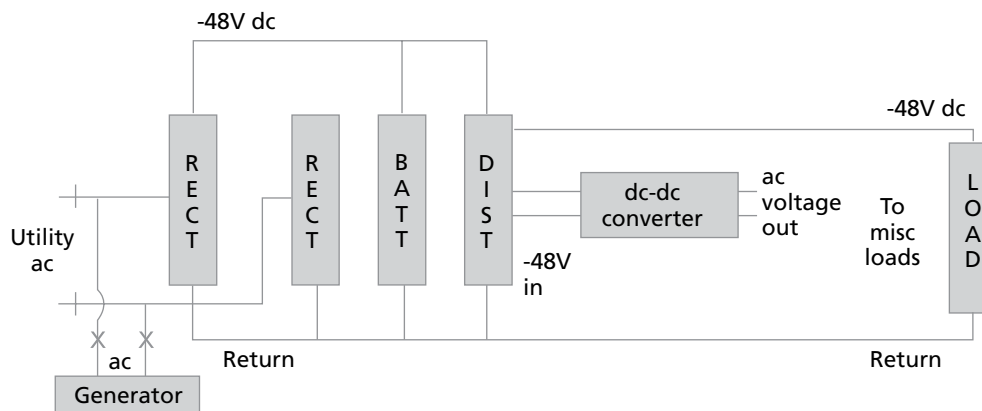

11.13: A dc-dc converter system connected in series to a cell site's power system

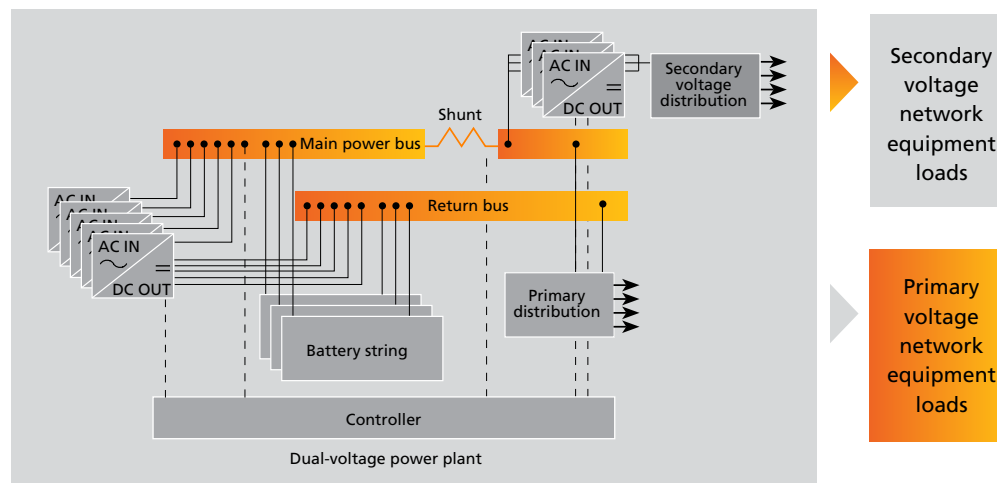

11.14: Supporting two voltages at a single site using one power plant and converters

Advantages of converting voltage

Modern dc-dc converters are essentially “plug and play” devices designed to fit in the racks alongside rectifiers and other converters (Figure 11.15).

This approach offers communications providers the greatest flexibility in adopting next-generation technology—offering new services while maintaining older standards.



11.15: Converters and rectifiers occupying adjacent power shelf slots

Disadvantages of converting voltage

On the downside, converting to a given voltage is inherently less efficient than drawing that voltage directly from the rectifiers, so losses increase as more and more dc power is converted away from the primary voltage.

Mapping the positions

Since a single power plant can generate varying amounts of both primary and secondary voltages, the need arises to assign numbers to the distribution positions of each voltage. A selectable voltage distribution panel makes this organization possible (Figure 11.16).

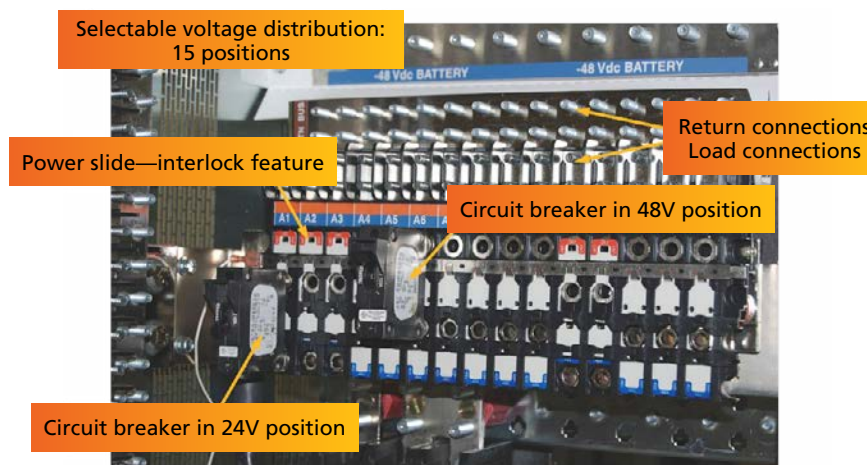

11.16: A selectable voltage distribution panel, showing both +24V and –48V applications

Integrated power systems

So far, we have focused on the individual components that comprise a cell site's power system. With so many components, you can imagine how quickly the space limitations of a site's shelter or cabinet become an obstacle.

To address these space limits, CommScope produces integrated power systems with several components built into a single device and suited for installation in a single rack. This approach is increasingly common in modern cell sites.

A typical integrated cell site power system includes one or more shelves of rectifiers along with one or more shelves of dc-dc converters. This integrates power conversion and power distribution functions, connecting them with bus conductors. The distribution system contains an integrated dc bus, fuses or breakers and cabling tie-downs to distribute power to the load (Figure 11.17).



dc-ac inverters

Some of the equipment operating at a cell site may require ac current from battery backup supplies. Since the entire system is built around dc power, a dc-ac inverter is needed to provide the necessary ac voltage (Figure 11.18). There are two basic types of inverters:

- **Offline inverters** feature an ac input and an ac output with a standby dc line connection available. This is the type generally used in cell site applications.
- **Online inverters** feature a dc input and an ac output with an optional ac standby line available.

Like dc-dc converters, the input for a dc-ac inverter is supplied by the primary power plant. Like converters and rectifiers, inverters are often installed and configured for redundancy. A static switch maintains equalized voltage to the load by switching automatically between external ac power and the inverter's ac power. This switching is done instantaneously—assuring no interruption in operation.

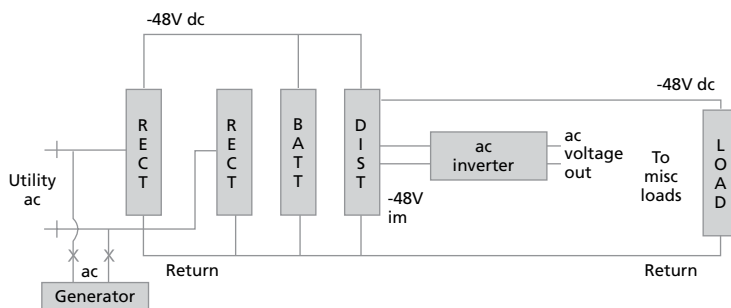

Integrated power systems

Space-saving combinations of related components built into a single device for easy installation.

11.17: (LEFT) An integrated rectifier, dc distribution and controller power system

11.18: (RIGHT) A dc-ac inverter system connected in series to a cell site's power system

ac power sourcing flexibility

With ever-increasing utility costs, the ability to combine power from renewable sources with utility power is another aspect of power flexibility. To address this, some rectifiers can accept ac power

from attached solar panels or wind turbines just as easily as they can draw it from the utility's transmission lines. An illustration of this flexibility is shown below (Figure 11.19).

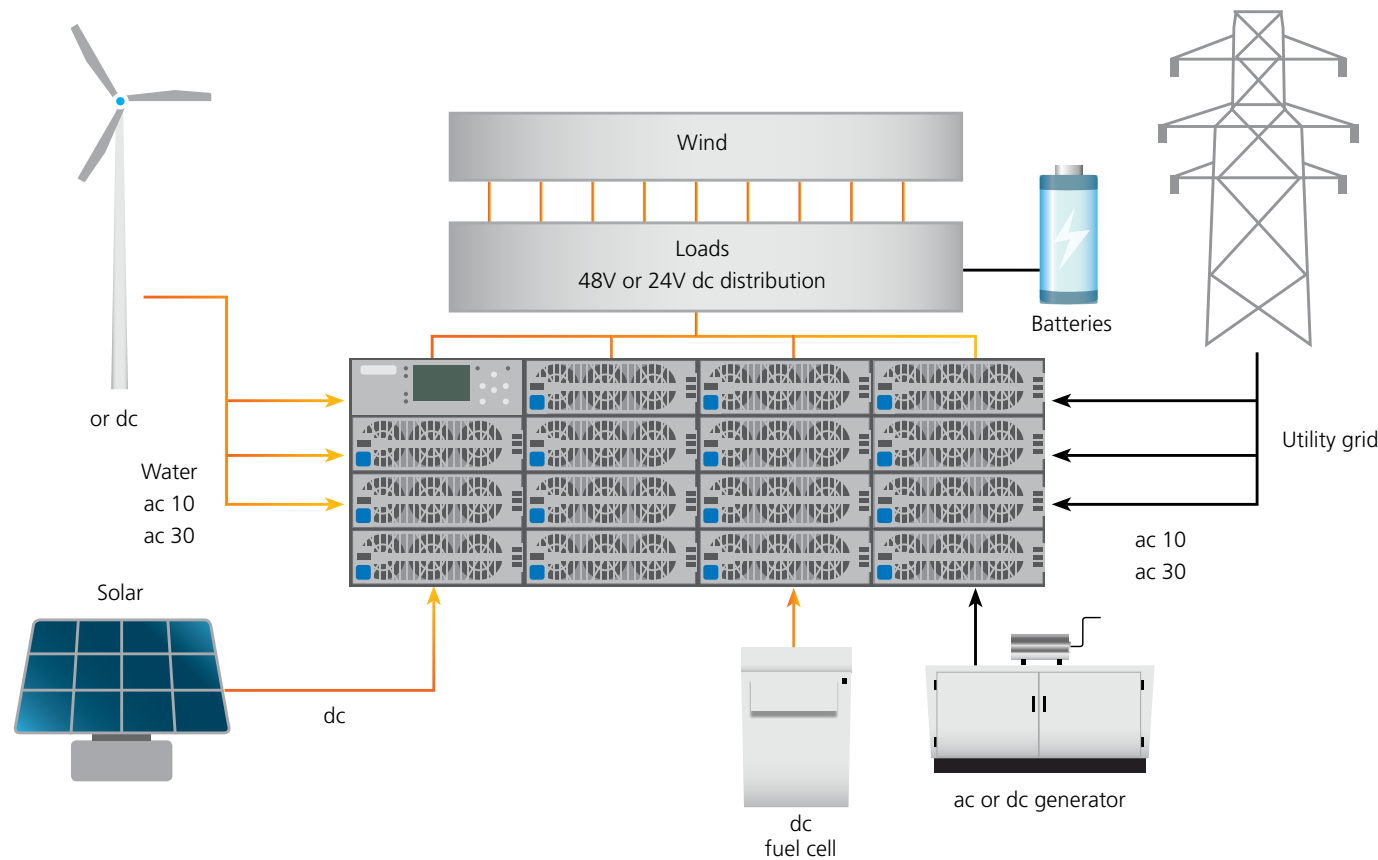

11.19: Power source flexibility lets rectifiers draw from conventional or renewable sources

Architectural improvements to power management

Significant RF power losses occur as a signal moves from the radio transmission equipment in a cell site's base station shelter to the antenna up on the tower. These losses are a natural consequence of traversing long stretches of coaxial cable. However, the simple architectural change of moving the transmitter and amplifier—known collectively as the “radio head”—from the shelter to the tower eliminates these losses and reduces power requirements. This design is called the “remote radio head” (RRH).

The baseband equipment remains on the ground and external ac power still enters at the cabinet or shelter. But, with the transmitter amplifier mounted adjacent to the antenna on the tower, more space is freed up and less shelter heat management is required.

Because of its exposed location, the tower top is not suitable for the battery backups—but other RRH equipment can be easily sealed against the elements. Instead of coaxial cable running up the tower, now only power transmission lines are needed. A typical RRH power architecture is shown in the figure below (Figure 11.20).

As useful as this design is, it also introduces new challenges. For instance, since the battery backup is now located far away from the critical components in the RRH, a heavier gauge of power transmission line is needed unless the power is converted to a higher voltage down at ground level and then converted back to the needed voltage (+24 V or –48 V) at the RRH itself.

To address the issue of tower line power losses, CommScope has developed a solution called PowerShift™. For information regarding PowerShift, see page 167.

Remote radio head (RRH)

A feature of base station architecture that separates a cell site base station's RF and baseband functions by locating the radio on the tower, near the antenna, for improved energy efficiency.

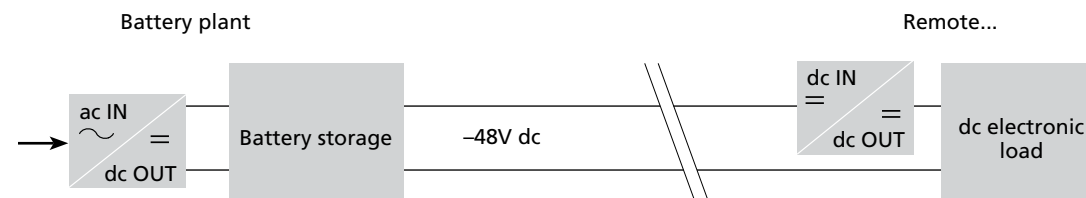

11.20: dc powering options for remote radio heads (RRHs)

Cell site power system configurations

Different cell sites store their power equipment in different ways. Some sites have equipment shelters at the base of the cell tower. Inside these climate-controlled enclosures, equipment is mounted in equipment racks, with an integrated power system in one rack and battery strings in another, and radio equipment in still another.

Other sites place integrated compact equipment in outside plant (OSP) cabinets. This approach offers less space and fewer opportunities for environmental management, so only components specifically designed for OSP cabinet environments can be installed. Because of their size, often batteries will have a dedicated cabinet as well. A few examples of OSP cabinets are shown in Figures 11.21 and 11.22.



11.21: Integrated cell site battery-only cabinet



11.22: Integrated cell site power and battery cabinet

Powering tomorrow's wireless networks

As wireless networks mature in the LTE age and set the stage for the 5G evolution, there have been several macro-scale strategic challenges that have emerged in powering the most cutting-edge technologies and architectures.

- **Increasing power demands on the tower**

As wireless networks evolve, their power demands continue to increase. Dual-band remote radio heads (RRHs), higher power carriers, and massive multiple-in, multiple-out (MIMO) antenna configurations are some examples of tower-top units that drive dc power consumption above one kilowatt—even approaching two kilowatts of demand.

- **How much copper is really needed?** There is no single standard for determining the right size of conductors to use when connecting dc power to tower-top electronics; so, to make a good selection, one must consider several factors:

- **Voltage drop.** As current flows through conductors, there will be voltage drop due to the resistance of the cable itself. This means the tower-top electronics will always have a lower voltage than the power plant or the ground-mounted equipment. The tower-top equipment is constant power, so, the lower the input voltage the higher the current needs to be to maintain the output power level. Voltage delivered

to the tower-top equipment will depend on the power plant voltage, the size of conductors and the length of the conductors.

- **Design case.** The critical factor when sizing conductors to connect tower-top electronics is the power plant voltage when the primary power is lost and the cell site is powered by the battery. When primary power is lost, the battery provides power for the cell site. The battery starts at 48 volts and will drain down (Figure 11.23) until the battery disconnect is triggered or the electronics reach their low-voltage drop-out value.

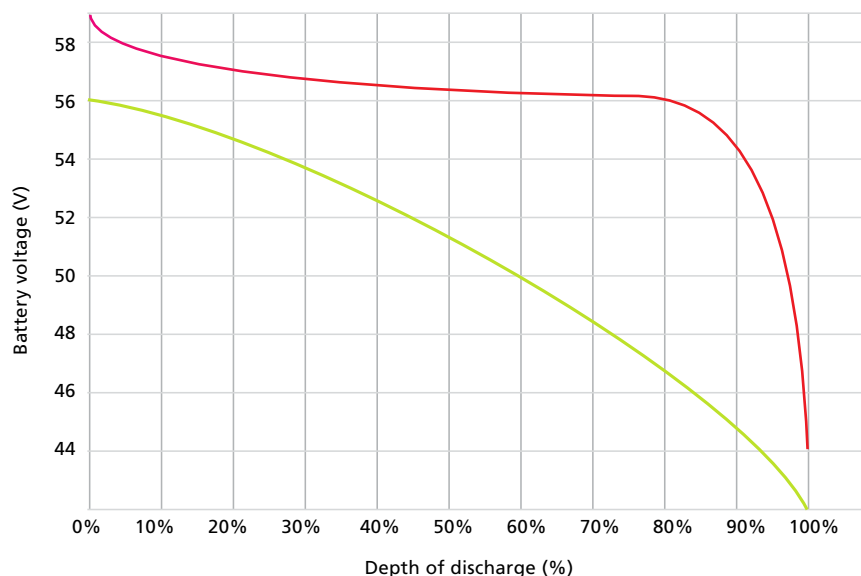

11.23: Integrated cell site battery-only cabinet

- **Battery backup time.** Depending on the reliability needed for a particular cell site, the tower-top electronics should have enough battery backup time for a technician to reach the site and ensure the generator has successfully started. This can range from one to eight hours.

The rule of thumb is to size the conductors for a five-volt drop when the cell site is on battery (48 volts). When the battery powers the cell site, it will provide 48 volts, so the tower-top electronics will initially receive 43 volts and the tower-top electronics will remain powered until it sees about 38 volts (which means the battery has drained down to 43 volts). If the conductors are sized based on voltages supplied by the rectifiers while the primary power is connected it is likely the tower-top electronics will either drop out when battery is engaged or there will be little backup time. [Here are some links to tools](#) that will help properly size conductors.

- **Power line losses.** Energy efficiency really matters for cell sites. Power loss is a function of the cable's resistance multiplied by the square value of the current. Use 54 volts to calculate the current for efficiency since the rectifiers provide 54 VDC power to the RRUs when primary power is connected.

- **Electrical codes.** When the tower-top electronics were just 400 to 500 watts, the currents were so low the conductor amperages for codes were typically not factors—voltage drop was the only criteria. As the power requirements have increased, electrical codes such as the National Electric Code have become a factor since the amperages in conductors can be exceeded for flexible cords.

In the U.S., reference the latest NEC table 400.5(A)(1) and 400.5(A)(3) if using SO type cables and Table 310.15(B)(16) and 310.15(B)(3) (A). Outside the U.S., reference the applicable standard for flexible cable ampacity.

- **Cost.** The initial cost of the cable and installation should be weighed against battery backup time, tower loading, permit costs, etc., in order to select the optimum conductor size.
- **Future proofing.** Consider the site evolution over the next few years so an upgrade is not needed soon after the cell site cabling is completed.

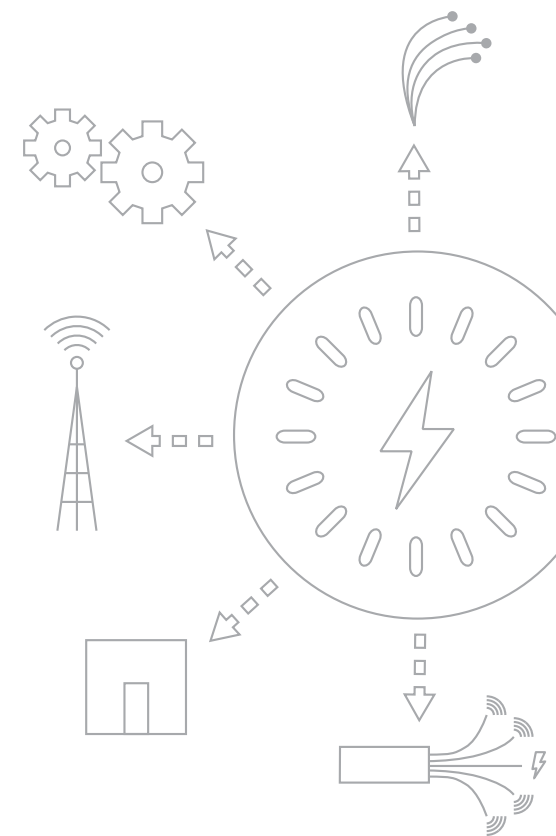

PowerShift™ solution

Developed by CommScope and GE to address cost-effective solutions for higher-powered tower-top equipment, PowerShift will regulate 54 volts at the remote equipment by providing a higher dc voltage at the base (Figures 11.24 and 11.25). This reduces the current in the long conductors, which allows a much more efficient transmission of dc power. PowerShift will also vastly improve battery backup time by keeping the remote electronics at 54 volts—even as the battery drains down to as low as 36 volts (Figure 11.26).



11.24: CommScope's PowerShift solution

You can find more information about effectively using battery backups [in this white paper](#) and see how to size conductors properly for use with PowerShift with [this tool](#).

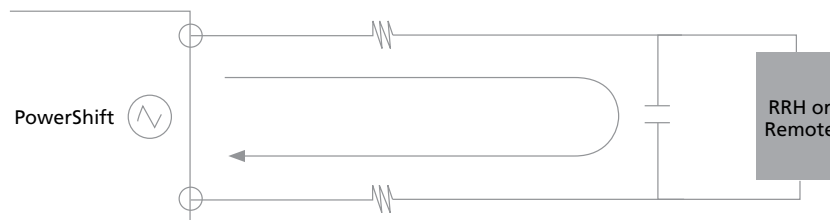

11.25: Wiring diagram of PowerShift in the circuit

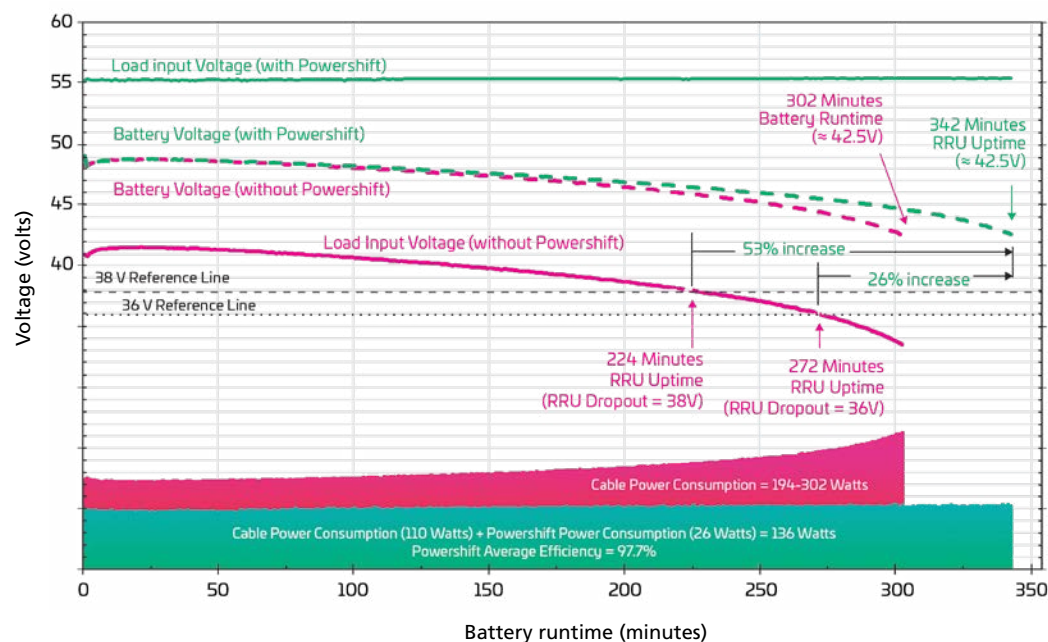

11.26: PowerShift in operation

Small cells, 5G and getting power to the edge

To increase network capacity, wireless operators must increase the density of their networks—adding more antennas and radios to existing sites, and deploying more sites where the demand is greatest. For the latter approach, small cells (low-powered, easily-concealed integrated cell sites) are a popular way to increase network density in heavily-populated urban areas where traditional macro sites can't be installed. Small cells are also a vital component of the migration to 5G; it's estimated that a full implementation will require tens of millions of them.

Wherever they are located, small cells require both data (fiber-optic cable) and power (copper) in order to function. Hybrid cable, containing both fiber and copper, makes this possible. However, with the proliferation of new small cells, a new distributed power connectivity strategy is required to manage it all efficiently.

CommScope has developed a new approach that uses hybrid fiber cabling to deliver power and connectivity from a central location to a cluster of neighboring small cells. A suitable centralized location can be anywhere that has access to power and the optical network, such as an outdoor distribution cabinet, telecom closet or macro base station location. With dc-dc conversion

rates now exceeding 95 percent efficiency, using higher-voltage distribution enables longer dc power runs that extend hundreds of meters. This greatly simplifies the amount of infrastructure work required to power small cells without involving extra work from utilities providers—a big advantage for wireless operators.

These deployments are most efficient when used for new clusters of small cells, since that's the best time to plan a centralized power source that can serve the maximum number of neighboring small cells. It also has the added advantage of cutting-edge fiber-optic speed, bandwidth and low latency that optimize LTE today and enable 5G tomorrow.

Small cell power— a detailed analysis

Download this featured white paper on the future of powering small cell networks now!

[Download white paper](#)

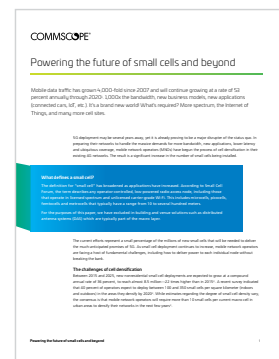

Powering distributed antenna systems (DAS)

The power behind indoor coverage

DAS is a technology that enables cellular coverage and capacity in an indoor or mixed indoor-outdoor space. It is a network of remote antennas connected to a radio and baseband unit that is integrated with the outside macro wireless network. DAS is a popular way to improve indoor connectivity or to offload massive amounts of concentrated traffic from the macro network—such as at a sports stadium, an airport or an office building, where high amounts of traffic in a relatively small space can overwhelm the broader network.

The primary challenge with DAS is powering the remote antennas—because a DAS may include dozens or even hundreds of remotes, all connected by copper or fiber and each requiring power to carry traffic. That means they will also draw battery power should line power be interrupted.

Here, PowerShift again proves to be an effective addition to power strategy. Because PowerShift allows the entire DAS to be powered from a centralized location, the DAS operator can deploy a single (or more than one) battery plant at the headend rather than deploying individual battery backups all over the network. Also, because

PowerShift can intelligently adjust voltage to compensate for line loss, it allows longer cable runs to the most distant DAS remotes. Its capacity to deliver up to 1,460 watts also makes it suitable for powering high-capacity, multiple-in, multiple-out (MIMO) remote configurations.



11.28: A PowerShift-loaded distribution cabinet, providing power to a football stadium's DAS remotes

Keeping the power and communication flowing

It takes a lot of thought, planning and effort to deliver and support our always-on, 24/7 world of communications. When power outages occur, as they inevitably do, it falls to forward-thinking engineers and companies like CommScope to put effective, reliable contingencies in place.

Many of the same systems that keep your home electronics in good working order—such as battery backups, circuit breakers, dc converters and surge protectors—also keep our national cellular backbone in a state of constant readiness.

Interruptions in power shouldn't mean interruptions in our lives. With the technology and expertise of CommScope and our partners in the communications industry, they don't have to.

Chapter 11 summary

Powering macro sites

- dc and ac power
- Battery backups engage to bridge generator in event of line power failure
- Modern networks draw more power and can benefit from intelligent dc power supply such as PowerShift

Powering metro sites

- Metro (small cell) sites are located on the edge of networks
- Central to coming 5G rollouts
- Unique power distribution needs, including intelligent dc power supply

Power distributed antenna systems (DAS)

- Dozens/hundreds of remotes require precise voltage
- Varying cable run lengths complicate line loss
- Intelligent dc power supply automatically scales voltage to overcome line loss
- Also simplifies needed battery backup architecture

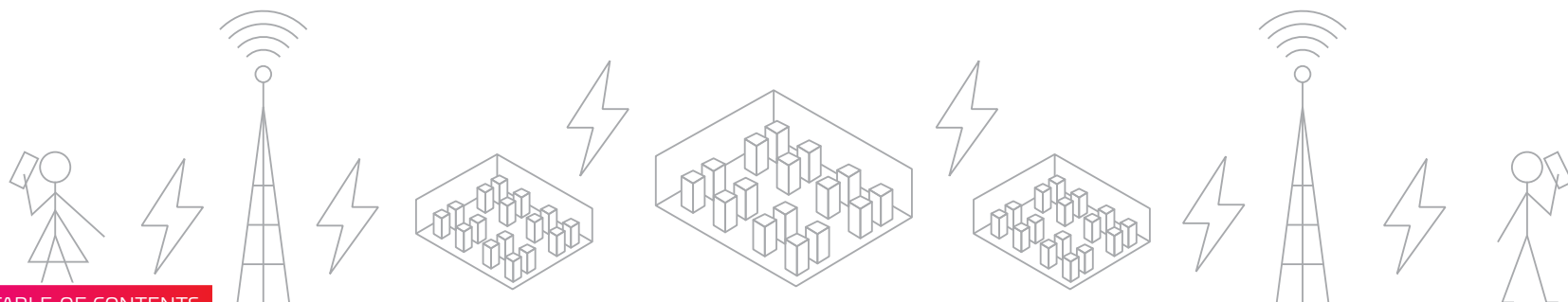

Successfully planning against failure: Reliability in wireless systems



Chapter 12

It's simply a fact of life that items left out in the elements will become more susceptible to problems as a result of such exposure. Outdoor furniture ages more quickly than indoor furniture, the car parked at the curb shows more wear than the car kept in the garage. As a matter of necessity, a home's exterior paint will need refreshing more often than its interior. The elements, as a rule, are harsh.

Planning for environmental punishment is also a key concern for cell site operators, as new efficiencies that wring more work from every watt often mean placing components farther out into the network, and that means placing them outdoors, high on antenna towers. The same degrading effects that peel a house's paint work relentlessly against the sensitive electronics that drive modern cellular communications.

The precise balancing act of increased component failure rates against operational efficiencies has led to a revolution in how cell towers and cell systems are developed and built.

CommScope is at the forefront of this new network architecture and its impact on reliability. We offer the tools and expertise to help operators maximize redundancy, improve weatherizing and plan for system component failure.

Reliability, objectively defined

In everyday conversation, reliability usually refers to your experience with a device or service. It's somewhat subjective in that no two people have exactly the same experience, and they don't react in the same way when a problem does occur.

For instance, your home internet service may occasionally go down for a few minutes in the middle of the night; but, since you're not using the internet when it happens, you would refer to your service as highly reliable even though it occasionally fails. Another person might need a stable connection during a particular time of day and experience an internet outage during that critical moment. Even though the interruption may last only seconds, that person would describe his connection as unreliable.

In engineering terms, however, reliability takes on an entirely new meaning. It has an objective, empirical value based on study, analytics and calculation. In this sense,

Reliability

The probability of a device working correctly over a defined length of time, operating under specified conditions.

reliability is defined as the probability that a product or service will perform as it should at any given time, under specific conditions. In engineering, “failure” is something to be anticipated and controlled. It may be compensated for via system redundancy.

Generally, reliability rates can be defined with a classic bathtub curve, so named for its bowl-like shape (Figure 12.1). As you can see, it predicts higher failure rates at the beginning and ending of a device’s life cycle. For any given device, this graph provides a general guide as to its rate of failure—decreasing initially, and increasing during end of life.

The three stages of component life introduce three common causes of failure:

1. Early-life initial failure may be due to manufacturing problems, incorrect installation or damage during shipping.
2. Steady-state constant failure indicates random failure as a normal function of operation. This is the stage we are most concerned with in this chapter.
3. End-of-life wear-out failure occurs when fatigue, corrosion or other factors accumulate to the point where failure becomes more and more likely.

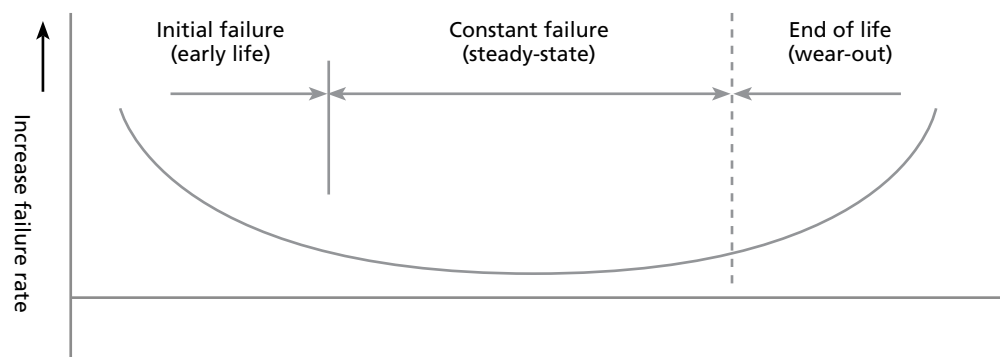

12.1: The reliability “bathtub curve,” showing the failure rate over the operational life of a device

Determining when a device's end-of-life stage occurs depends on complex computations. For example, one must take into account known life expectancy of the device's main components, such as motors and fans with moving parts that are eventually subject to mechanical wear.

Similarly, electronic components also have life expectancies. For example, electrolytic capacitors used in wireless electronics are subject to degradation from high temperatures and ac ripple currents.

Quantitative reliability predictions

As you might expect from a complex wireless communications system, predicting likelihood of failure is a complicated process, but a necessary one. There are several methods:

1. Collection of empirical field data from customers
2. Accelerated life testing data
3. Prediction models based on "parts count" method
4. System availability models for large systems with internal redundancy

Each method offers different advantages. The "parts count" method, for instance, is particularly useful for new product designs, even before the product moves beyond its design stages. This method applies

established life cycle information for the components used in the design—the steady-state failure rates indicated in Table 12.2—to create an aggregated model of potential failures.

This computation relies on industry software reliability prediction tools such as Telcordia SR-332 Reliability Procedure for Electronic Equipment. It adds up individual component failure rates and applies designer-specified multipliers accounting for specific temperature, electrical stress, production quality and environmental conditions to yield a final, steady-state failure rate for the component. The various stress parameters are:

- Stress factor for operation is de-rated from specified limits
- Temperature factor (often adjusted up or down from a reference point of 40°C)
- Quality factor accounting for supplier and process controls
- Environmental factor accounting for indoor vs. outdoor conditions

From such prediction tools, a designer can compute a predicted failure rate with a 90 percent or greater confidence limit, which means at least a 9-out-of-10 chance that the actual failure rate will be no higher than predicted. These estimates usually reflect conservative numbers, making them highly reliable predictors.

Stress factors

Of the several stress parameters, perhaps the most critical factors in predicting reliability in the wireless communications industry are temperature and environmental stress.

Temperature factor, more specifically operating temperature, is the sum of the ambient temperature and the temperature of the heat produced by the component itself. In practice, a 10°C increase in operating temperature can double the likely failure rate. Likewise, reducing the temperature by a similar amount can reduce predicted failure rates by up to 50 percent.

Environmental factor is just as important as a predictive element. For example, an outdoor environment introduces a multiplier of 1.5 to 2.0, depending on the outdoor application. This factor accounts for variations in temperature, vibration and other environmental variables in an uncontrolled outdoor deployment versus the same equipment in a climate-controlled enclosure. Recent data suggest that a 1.5 factor is typical for outdoor wireless equipment such as tower-mounted antennas and remote radio head (RRH) equipment. Much of this data was collected by monitored RRHs.

Water ingress protection starts with the careful analysis of points of ingress, design considerations for protection of critical RF connection points, formulation of condensation and management of condensation. Addressing each element often means tradeoffs between cost and efficiency in the design.

The final product of the reliability prediction tool includes detailed, part-by-part information such as that shown on the right (Table 12.2).

Part number	Category	Unit FR (FITs)	Quantity	90% CL Failure rate (FITs)	Ref des
7094037	Capacitor	0.21	1	0.26	C37
7131706	Resistor	0.57	15	9.42	R3, R44, R6, R20
7131748	Resistor	0.57	3	2.10	R150, R151, R152
7131797	Resistor	0.57	9	5.80	R1022, R243
7144735	Capacitor	0.21	10	2.24	C152, C162
7144739	Capacitor	0.21	2	0.49	C58, C740
7164258	Miscellaneous	3.80	5	25.82	AT1, AT2
7165048	Resistor	0.57	1	0.80	R126
7500917	Resistor	0.57	1	0.80	R23
7501483	Resistor	0.57	1	0.80	R135
7512949	Capacitor	0.21	1	0.26	C1053
7541771	Integrated circuit	6.02	2	16.66	U1007, U1011
7563383	Integrated circuit	6.02	1	9.31	U1017

12.2: Example of a component reliability table

Measuring reliability

As mentioned above, reliability is the probability that a device will perform correctly under defined operational conditions over a specific span of time. But supporting this general definition are several practical ways of measuring reliability in real-world applications.

Mean time between failure (MTBF) is the time between two consecutive failures. This is the most common definition for

reliability. MTBF is expressed as the inverse of the failure rate.

$$\text{MTBF} = 1 / \text{Failure rate} = 10^9 / \text{FITs}$$

Mean time to repair (MTTR), sometimes called mean time to restore, is the time needed to repair or replace a failed component and restore its function. This includes procurement and travel time, so the figure is comprehensive in its scope.

Availability (A) is the percentage of time the system as a whole operates normally. When someone refers to “four nines of reliability,” they mean “99.99% uptime” (Table 12.3). Availability is a function not only of how often a component fails, but also how long it takes to restore service when it does fail, so it figures in both MTBF and MTTR.

$$A = \text{MTBF} / [\text{MTBF} + \text{MTTR}]$$

When describing the reliability of an entire system, availability is a more useful measurement. That’s because redundancies built into the design may tolerate some individual failures without seriously compromising the function of the system as a whole.

Unavailability (U) is the flipside of availability, in that it expresses the percentage of time a system is not working properly. Also, like availability, it can be calculated as a function of MTBF and MTTR.

$$U = \text{MTTR} / [\text{MTBF} + \text{MTTR}]$$

As you may expect, A + U always equals 100%.

Downtime (DT) is derived from unavailability and expressed as the average amount of time per year the system will be in an unavailable state. Since it measures failures that often last only minutes, and expresses them as a percentage of a full year, we simply multiply the unavailability percentage by the number of minutes in a year, or 525,600.

$$\text{DT} = U \times 525,600$$

To illustrate, consider a system with 99.99 percent availability, or “four nines.” That means its mathematical value is .9999, resulting in a U value of .0001. Multiplying .0001 by 525,600 yields an expected annual downtime of 52.5 minutes per year, or less than a full hour. This is a key indicator in overall service quality (Table 12.3)

Failures in time (FITs)

The number of expected component failures per billion operating hours.

Percent availability	Number of nines	Downtime (minutes/year)	Service quality level
99%	2-Nines	5,000 m/y	Moderate
99.9%	3-Nines	500 m/y	Well managed
99.99%	4-Nines	50 m/y	High availability
99.999%	5-Nines	5 m/y	Very high availability

12.3: Service quality measured by uptime; more nines mean more availability

Availability on a systemwide scale

Because of the vast number of components that make up a wireless communications system—each with their own failure rates, redundancies and importance to overall operation of that system—predicting long-term performance of the system as a whole can be quite a challenge.

From a design standpoint, cost constraints make it impossible to build components that are not subject to some degree of failure. Therefore, the design may incorporate redundant subsystems to avoid complete system unavailability due to any single component's failure. Properly implemented, these subsystems will allow the system to continue functioning at full performance, even in its degraded state, until repairs can be economically performed on the failed component.

Budgeting for failure

Dividing a system's functionality into subsystems allows a "reliability budget" to emerge. By breaking down the complex whole into manageable segments, subsystem reliability can be more easily modeled based on its parts count or by another appropriate method. Then, the likelihood of failure of the entire subsystem can be modeled to learn its effect on the overall function of the system itself.

In a practical example, consider the mass of electronic components mounted atop a cell site tower. The system can be broken down into subsystems involved in the transmit path, the receive path, the power system and other related functions. Each of these will have a maximum allowable

failure rate assigned based on its importance to the operation of the system. So the site's designers can plan accordingly, the overall reliability budget is split up and allocated where it is needed most.

In practical applications, these models are more concerned with the functioning state of a system or subsystem, rather than with the actual hardware or software itself. At this level of planning, MTBF and MTTR become more meaningful descriptors of reliability than failure rate alone.

Failure mode, effects and analysis (FMEA)

Given enough time, component failure is a certainty. Where and when it occurs, however, is a variable that must be modeled to be predicted.

That means a lot of what-if scenarios, not only of component failure but the effect of that failure on its subsystem and the effect of that subsystem on the system as a whole. For this kind of analysis, failure mode, effects and analysis (FMEA) is a simple, table-based method of measuring these variables together.

The FMEA for a particular system lists each failure mode and its effect on overall system performance. Failures that result in total loss of service are combined to calculate the system's total availability, while failures that cause only minor effects on service are combined to calculate the system's partial availability.

Fault-tolerant design

Redundancy is the key to boosting availability within a system without requiring the subsystems to be more reliable themselves. Redundancy schemes vary by application, but they all have one thing in common: on-demand access to a device or service that can assume the function of a failed device until it can be repaired or replaced. Sometimes this includes a spare component; other times, it means shifting load to other systems. Common redundancy schemes include:

- Active/hot standby, a spare component built into the system that operates all the time and can assume more load when needed due to primary component failure
- Active/cold standby, a spare component built into the system, which only comes online in the event of failure, with a possible interruption in service
- 1 + 1 load sharing, providing two active routes for communications so one will be available in the event that component failure causes an outage in the other
- N+1 load sharing, providing a standby alternate route for communications to assume the load in the event that component failure causes an outage in any of the other routes

The downside of adding redundancy is increased cost. Therefore, redundancy should be added in circumstances where benefits outweigh costs.

The reliability block diagrams

Another widely used approach to measuring system reliability is the reliability block diagram (RBD). Unlike the lists of the FMEA table, it graphically shows the interconnections between subsystems on a conceptual level and how redundancy measures are integrated. Also, unlike the FMEA table, these element “blocks” are described purely by function, not by individual component; the system’s reliability depends on how these blocks are connected. Arrows represent the direction of information flow, but may not necessarily correspond to the physical direction of current in the system.

How the RBD shapes up depends on the kind of system architecture under consideration. A typical architecture may include both redundant and non-redundant subsystems, as shown in Figure 12.4.

An RBD is extremely useful in predicting system reliability, but it does have disadvantages. The main limitation is its static nature: it can only predict individual failures without accounting for cascading effects throughout the system as it continues to operate in a degraded state.

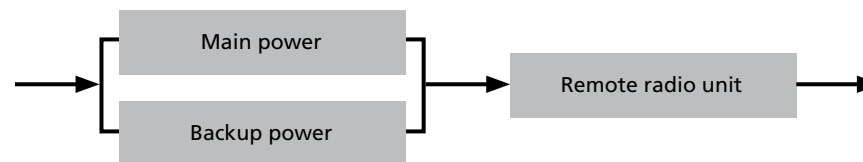

12.4: A simple RBD showing redundant power and non-redundant radio unit

State transition diagram (Markov Model)

In non-redundant systems, there are two states of being: working and not working. Transitions between these two states are defined by failure rates (1/MTBF) and repair rates (1/MTTR). Between these two measurements, availability can be easily determined.

However, more complex and more fault-tolerant systems have many levels of operational efficiency. We have referred to systems operating in degraded states, or a state of partial failure. To measure the reliability of these complex systems, the Markov Model defines all possible degrees of a system's operation and maps every state transition involved in making those states occur.

To illustrate, consider a simple system with two subsystems, A and B, each with the same failure rate

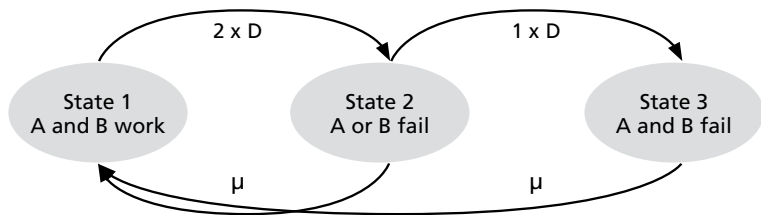

12.5: A basic Markov Model describing the three possible states for a two-subsystem design

(Figure 12.5). As you can see, there are three possible operating states: fully operational, partially degraded and completely unavailable.

The arrows indicate potential failure and repair transitions between states with the failure and repair rates for each. Different failure rates among subsystems naturally introduce additional variables, but the computations remain the same.

Markov Models can account for multiple combinations of failure conditions and the effect each has on system performance. This offers a better view of the comparative severity of different subsystem failures and what kind of degraded performance can be expected.

Markov Models are very useful in calculating the cost/benefit analysis of steps designed to reduce failure rates at various places within a system—essentially putting a “time and trouble” cost on any possible subsystem failure, which is particularly valuable when considering how difficult it is to service tower-mounted wireless communications equipment. It can also inform design decisions at the planning stage, taking into account accessibility factors early in the process. The downside to the Markov Model, however, is that it cannot assign a single MTBF value or failure rate to the system as a whole.

Reliability factors

Now that we are able to determine system reliability by multiple methods, we can examine what can be done to improve that reliability. These measures start in the design phase and carry through to installation and maintenance practices.

Product complexity is a primary factor to consider. Simply put, adding more components means adding more opportunities for failure. Take the integrated remote radio head (RRH) (Figure 12.6).

With thousands of electronic parts built into a single device mounted in an outdoor environment, the predicted failure rate may be as high as 5 percent per year. This rate takes into account the ambient temperature, internal temperature and the RRH's heat dissipation features, as defined by Telcordia SR-322 software. Reducing the number of components in this or any device will directly increase its reliability.



12.6: A compact, tower-mounted remote radio head

Redundant hardware improves reliability by increasing the number of states in which the system may operate, adding flexibility to address service levels and repair schedules. However, redundant hardware will not reduce maintenance costs and it requires a greater up-front investment.

Heat dissipation is vital to the long-term reliability of any electronic system or subsystem, whether mounted atop a tower or located in a ground enclosure. For instance, a 60-watt amplifier may generate an internal temperature rise of 25°C to 30°C, which, when added to an ambient temperature of 25°C, yields up to 55°C of heat, exceeding the default operating temperature of 40°C found in the Telcordia SR-322. Recall that reducing operating temperature by just 10°C may reduce failure rates by 50 percent.

Thermal limitations relate to how heat dissipation is handled in a device. In the example of the RRH, front- and rear-mounted heat sinks arrayed in fins dissipate internal temperature rise into the air. The larger the fins, the more heat can be transmitted away. Limitations appear in the form of mounting orientation, available space on the mount and the physical size of the RRH itself.

Environmental issues are a key factor when dealing with electronics mounted outdoors atop a cell tower. Temperature variations, moisture, lightning strikes and other local conditions all play a part in how reliability is measured and improved. Each consideration should be thoroughly qualification tested and take into account prevailing industry standards.

Thermal design considerations

- Robust margins for thermal tolerance
- Design to conform to outdoor cabinet specifications
- Integrated thermal protection against over-thermal conditions

Mechanical considerations

- Resistance to high winds and vibrations on rigid mounting
- Accommodation of expansion and contraction
- Mechanical change-induced drift compensation

Atmospheric considerations

- Resistance to water infiltration
- Resistance to corrosion, fading and peeling
- Connectors, seals and gasket design
- Proper lightning mitigation (shielding and grounding)

Installation practices are just as important as design factors when it comes to ensuring reliability. As discussed in Chapter 2, it's vitally important to work with a competent and experienced cell site services company with well-documented safety records and tower climb-certified technicians to handle both mechanical and electrical services.

Qualified technicians will reduce the chances of improper lightning protection, poor connections, mishandled feeder cable and weatherproofing problems. In the long run, maintenance and troubleshooting are much easier and less disruptive to your network when trained professionals handle your work.

Reliability testing

A number of reliability test programs are designed to improve product reliability from early design prototype to deployment. Such tests include the following.

Design validation testing (DVT)

Products are tested to RF, electrical, and mechanical specifications contained in their product specifications. Testing can include, but is not limited to:

	Ingress protection	
	Antennas/RF components	Outdoor cabinets
Cold exposure	Test per IEC 60068-2-1 at -40°C for 24 hr.	Test to -40°C per GR-487-CORE.
Heat exposure	IEC 60068-2-2 at +70°C for 24 hr.	Test to +46°C per GR-487-CORE.
Temperature cycling	IEC 60068-2-14 cycling between -40°C and 70°C for 96 hrs.; dwell times at limits shall be 1 hr. past chamber equilibrium and transition times between limits shall be less than 2 hrs.	Test from -40°C to +50°C per GR-487-CORE.
Damp heat (humidity)	Test per IEC 60068-2-30, Test Db; one 24-hr. cycle; 9 hr. at 25°C / 95% RH and 9 hr. at 40°C / 90% RH with 3-hr. ramp transitions.	Perform 7-day temperature/humidity cycling per GR-487-CORE for outdoor cabinets.

	Ingress protection	
	Antennas/RF components	Outdoor cabinets
Water ingress	IEC 529; for IP67 mated connectors: 0.5-hr. immersion under 1 meter of water (9.78 kPa at 25°C). (Unless sand & dust tests are required, physical ingress rating can be inferred from design and water ingress rating).	Telcordia GR-487-CORE Section 3.33 Water and Dust Intrusion
Sand and dust ingress	IEC 60068-2-68, or per Telcordia GR-487-CORE section 3.33 Water and Dust Intrusion	Telcordia GR-487-CORE Section 3.33 Water and Dust Intrusion
Wind-driven rain	IEC 60068-2-18 Test Ra, Method 1, using a four-quadrant spray chamber simulating 40-mph, 70-in/hr rain for a minimum of 4 hrs.	70-mph wind and 5.8-in/hr rain per GR-487-CORE

	Corrosion (salt mist)	
	Antennas/RF components	Outdoor cabinets
Cold exposure	IEC 60068-2-11 Test Ka (ASTM B117) for a minimum of 720 hrs at 35°C with a salt mist concentration of 5 wt% NaCl	720 hrs. per ASTM B117 and GR-487-CORE
Cyclic exposure	IEC 60068-2-52 Test Kb (Test Method 4 – 2 cycles) at 35°C with a salt mist concentration of 5 wt% NaCl	

Other tests include UV weathering effects from sun exposure:

- UV-A exposure with fluorescent lamps per IEC 60068-2-5, procedure B at 55°C for a minimum 240 hours
- Full spectrum UV-A/B exposure with xenon arc lamps per ASTM G155
- Other multi-year outdoor weathering tests in urban environments

Lightning protection:

- Test per IEC 61000-4-5, 1.2/50 μ s Voltage 8/20 μ s Current Combination Waveform, 10 repetitions @ ± 6 kV, ± 3 kA.

Some examples of testing and analysis in action are shown below (Figures 12.7 through 12.9).



12.7: Weathering and corrosion test of silver-plated steel products



12.8: UV and weathering test of base station antenna assemblies

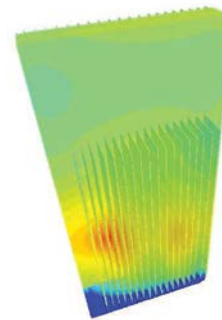

12.9: Remote radio head subassembly thermal simulation

Robustness and life testing

Accelerated life testing (ALT)

ALT is performed to demonstrate the long-term reliability of a product. During ALT, a sample of units is subjected to more severe thermal conditions than would normally be experienced in the field. This is implemented with a greater temperature excursion and an increased frequency of thermal cycles. Though product variable, a typical ALT includes high temperature dwells and thermal cycling to stress the unit's electrical components as well as their mechanical attachments. The duration of the testing is again product variable, but typical testing can last 60-100 days to evaluate the product's long-term reliability.

Highly accelerated life testing (HALT)

HALT reveals latent defects in design components and manufacturing that would not otherwise be found by conventional test methods. HALT stresses the products to failure in order to assess design robustness and marginality. HALT regimes may be tailored to the product architecture and complexity and can include:

- Step temperature stress
- Voltage stress
- Thermal dwell stress
- Rapid thermal cycling stress
- Random vibration stress

- Combined thermal cycling-vibration stress
- Other stress tests that may be product applicable

Recent developments in reliability

Thermal design

In the arena of thermal design, CommScope is always working to develop new designs and alternative materials to make heat sinks that more effectively transfer heat from components to the air. This approach means less reliance on costly and failure-prone cooling fans. As mentioned earlier, every 10°C reduction in operating temperature doubles reliability.

Internal redundancy

CommScope is focused on improving system availability. While not every single subsystem can be built to ideal fault tolerances, we're making every effort to cover as many subsystems as possible.

Field data analysis

CommScope continuously monitors field returns and performs root-cause analyses on those returns. These analyses inform our design and manufacturing processes, so we can prevent potential problems at the source rather than on the tower—and field results prove that the process works, showing continuous improvement over time. We're building a whole new layer of reliability right into each product.

Industry forums

In 2008, the International Wireless Packaging Consortium convened the Tower Top Reliability Working Group to address carrier concerns over the reliability of tower-mounted equipment.

The best minds from carrier companies, equipment suppliers and other industry experts split into subgroups in order to draft a comprehensive best practices document. Results will be published at future IWPC proceedings and early results suggest that the study will become an ongoing fixture in the development of industry standards.

CommScope is proud to share our expertise, as we are well-represented in several key subgroups and have participated with the team dealing with reliability prediction.

Ensuring a reliable network

In wireless communications, every design choice involves a tradeoff. In exchange for more efficient use of power and space in cell site deployments, there exists a greater risk of component failure. Such failures are a part of life, but they have to be part of the plan.

Predicting and measuring reliability can be a complex process with many competing aspects. Determining the reliability of a component, a subsystem or an entire cell site depends heavily on what matters most: maintenance time, upkeep costs, fault tolerance and a host of other

considerations. There are ways to improve reliability, but the tradeoff in cost may not always be worth it.

In modern communications, there are no “one-size-fits-all solutions.” Every step to improve reliability represents a careful balancing act between performance expectations, installation, and maintenance budgets and risk tolerance. CommScope helps make those decisions easier with the technology and insight that lets you choose the right solution from the best available options.

Chapter 12 summary

Reliability in wireless systems

- More tower-mounted equipment improves efficiency but poses challenges to reliability and maintenance
- Reliability over life span defined by bathtub curve

Reliability stress factors

- Temperature extremes
- Environmental stress
- Heat and heat dissipation

Measurements of reliability

- Failure rate
- MTBF

- MTTR

- Availability
- Unavailability
- Downtime

Reliability prediction tools

- FMEA
- RBD
- Markov Model

Testing regimens

- Design validation testing (DVT)
- Accelerated life testing (ALT)
- Highly accelerated life testing (HALT)

Reliability improvement opportunities

- Product simplification
- Redundant hardware
- Better heat dissipation
- Installation best practices
- Improved prediction tools
- Field data analysis and integration of findings into production processes
- Industry forum leadership

Extending the network indoors: DAS, C-RAN antenna systems, and small cell solutions



Chapter 13

Extending the network indoors: DAS, C-RAN antenna systems, and small cell solutions

A population map of the United States illustrates what you already know: people are not evenly distributed across the country—or even across a particular state (Figure 13.1). Look closer into any urbanized area and you'll find that these variances can be found block to block, building to building, or even from one floor to another.

Since denser populations require denser networks to serve them, there follows a need to increase the density of network capacity—a practice called, intuitively enough, *densification*—in these areas. This strategy begins with creating more outdoor sites and metro cells and increasing numbers of antennas per site. But another important part of densification is in-building wireless (IBW) solutions that extend the reach of an operator's network indoors.

For operators, it can be particularly challenging to provide reliable service in large indoor spaces, where user density is compounded by the fact that the macro network has great difficulty penetrating the concrete,

steel and low-e glass windows used in the construction of many buildings today. This physical barrier is responsible for those “dead zones” people encounter in certain parts of a building.

So how can one bring the network to the most densely-populated spaces—particularly high concentrations of users working indoors where the macro network can't reliably serve them? There are two answers: distributed antenna systems (DAS) and small cell technologies.

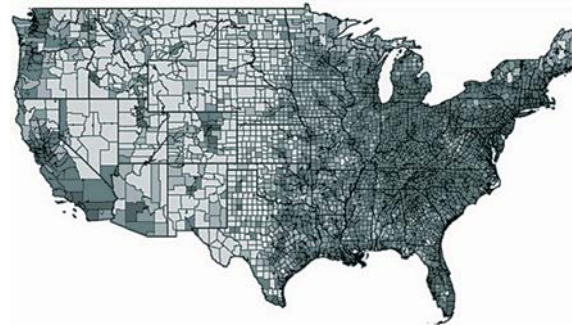

13.1: A map of the United States showing relative population density

Densification

A general term describing the practice of adding cellular capacity—often through specialized indoor or outdoor technologies—to better serve high user concentrations in a specific geographical area.

Distributed antennas systems (DAS)

DAS is a network of spatially separated antenna nodes arranged to provide additional coverage and capacity within a specific area, such as a building or a campus of adjacent buildings (Figure 13.2). It is one of the industry's longest-established wireless coverage and capacity technologies—capable of providing consistently high quality of service wireless coverage and robust capacity.

As you can see in Figure 13.2, DAS is a flexible solution that can be used to provide coverage and capacity for:

- Large indoor areas, such as high-rise office buildings, exposition halls, shopping center, hotels or hospitals
- A combination of indoor and outdoor environments, such as sports stadiums, airports, train stations or college campuses

Distributed antenna systems (DAS)

A network of nodes serving a specific place or building. They connect through a central base station for backhaul out to one or more operators' macro networks.

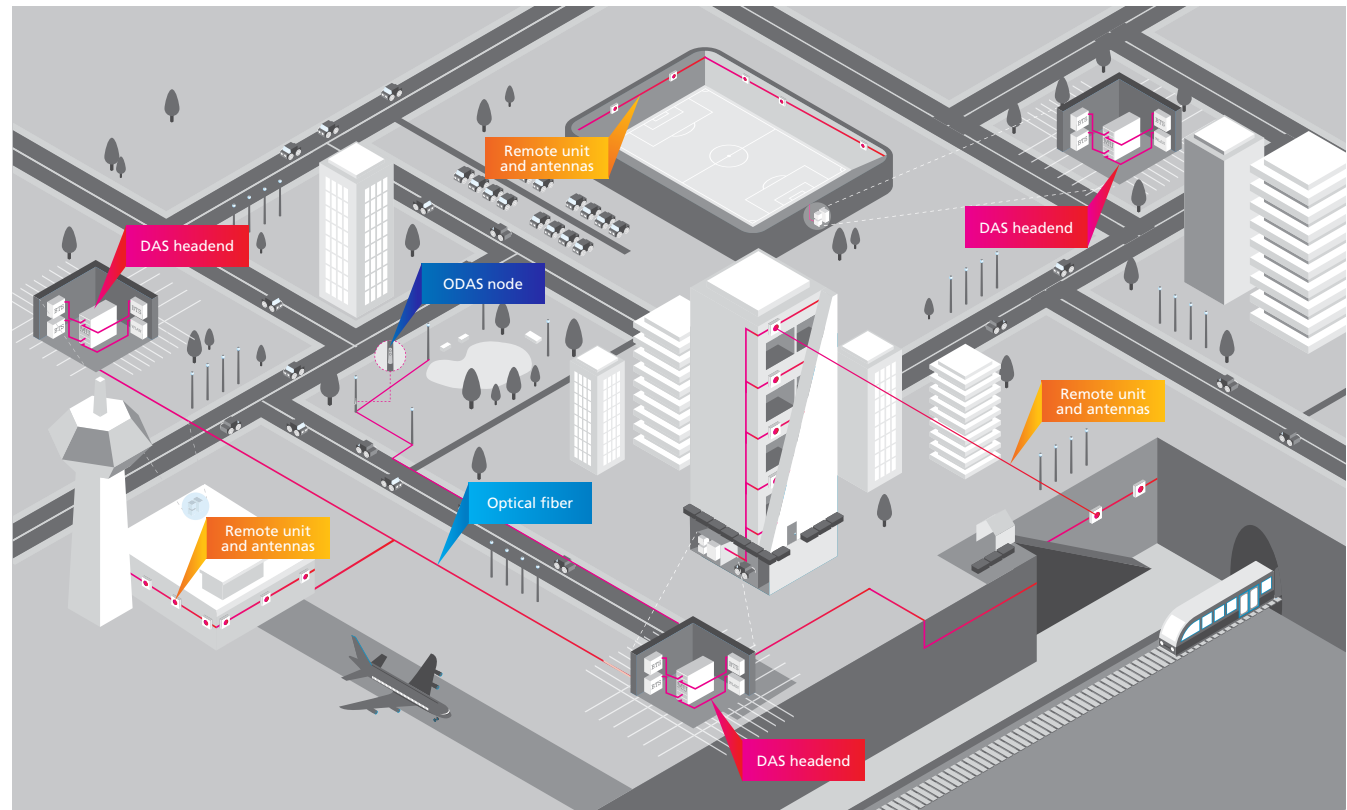

13.2: An overview of a typical DAS deployment

13 | Extending the network indoors: DAS, C-RAN antenna systems, and small cell solutions

DAS nodes are compact and designed to be inconspicuous so they can be placed almost anywhere. Figure 13.3 illustrates the broader architecture of a DAS deployment.

DAS is an inherently flexible technology, able to support multiple network technologies (2G, 3G and 4G/LTE) and interface with multiple carrier networks (Figure 13.4).

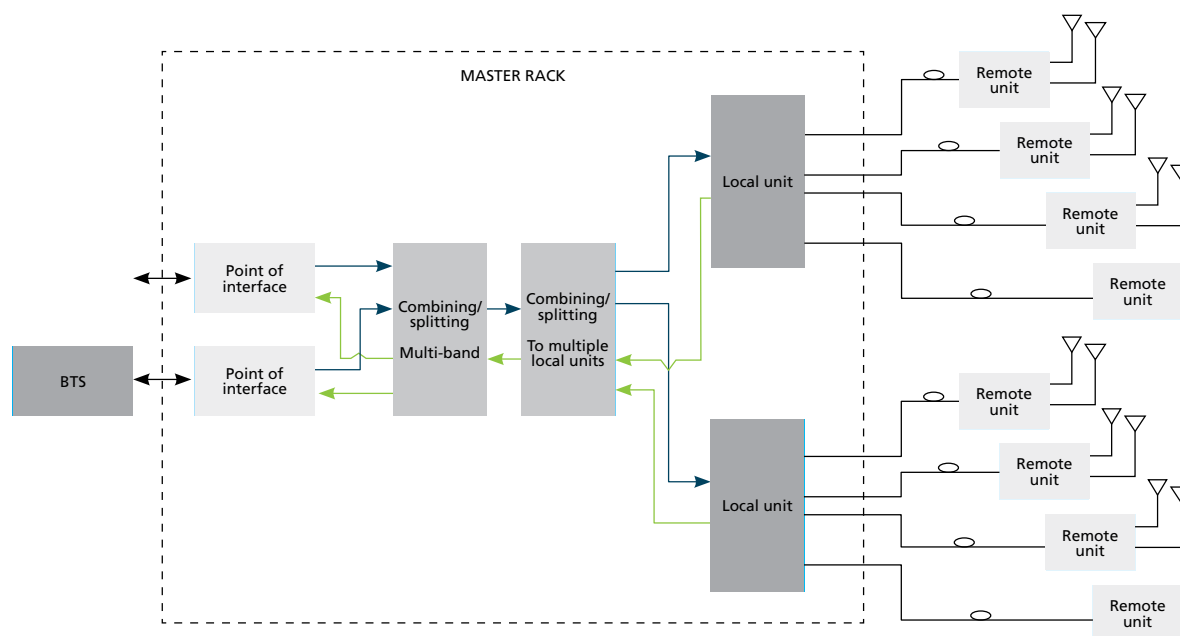

13.3 DAS general architecture

Frequency range	Service types
700 MHz	Analog, GSM, LTE
800 – 850 MHz	Analog, GSM, iDEN, CDMA
900 MHz	Analog, iDEN
1700 MHz	CDMA, W-CDMA, LTE
1900 MHz	Analog, CDMA, W-CDMA
2600 MHz	WiMAX

13.4: A summary of DAS-supported frequencies and network services

13 | Extending the network indoors: DAS, C-RAN antenna systems, and small cell solutions

DAS components

DAS is exactly what its name says—basically, a system of distributed antennas. It connects to the operator's network through that operator's own base station, which allows DAS to work with one, many or all available wireless operators in the market.

A DAS network layout is based on three core components (Figure 13.5):

- 1. Master unit.** This is the DAS interface to the outside world, connected to a nearby macro cell base station that provides access to the macro network.
- 2. DAS remotes.** These distributed devices receive traffic from the master unit via optical cable and relay RF transmission to and from the antenna via coaxial cable—or, increasingly frequently, through IT cabling (see below).
- 3. DAS antennas.** These are the entry and exit points between the DAS and individual network users. They relay traffic to and from the remote.

DAS also has the potential to dynamically adjust power levels across access points to meet changing levels of demand. Inclusion of an integrated monitoring and management solution can ensure the DAS maintains optimal performance, such as with CommScope's A.I.M.O.S. solution.

A.I.M.O.S. supports all CommScope DAS solutions with intelligent alarms delivered via text or email to alert administrators of any performance issues—often before users even notice anything is wrong—so they can be resolved quickly and efficiently.

Andrew Integrated Management and Operating System (A.I.M.O.S.)

The network management solution for all CommScope distributed antenna systems. Part of our Andrew Solutions portfolio, it performs configuration fault and inventory via SNMP for alarm forwarding.

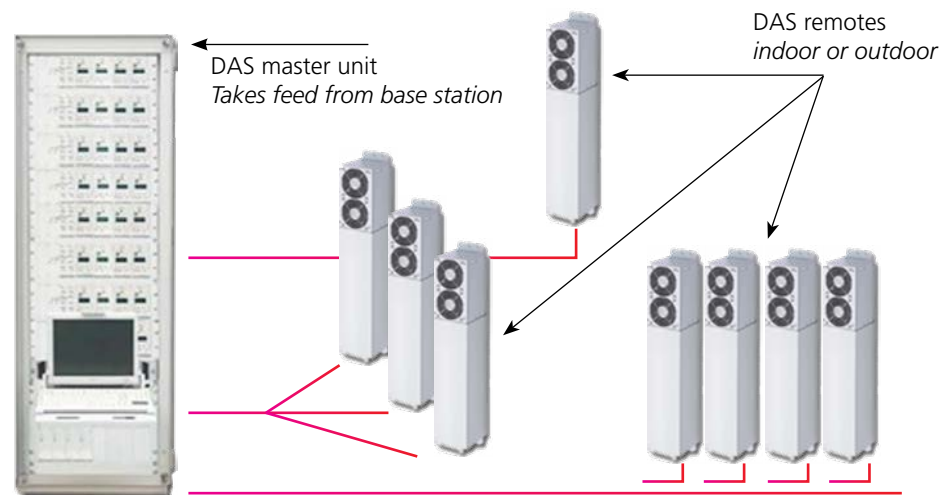

13.5: Typical DAS components—the antennas connect via coaxial to remotes

13 | Extending the network indoors: DAS, C-RAN antenna systems, and small cell solutions

Coincidentally, DAS deployments increasingly have another thing in common with IT networks—their fronthaul infrastructure. Modern DAS solutions use standard IT cabling—such as Category 6A Ethernet cable—to connect antennas to the fiber-optic vertical network. This development can greatly reduce the time, cost and skill set required to deploy DAS in an enterprise environment compared to traditional options that rely on coaxial RF cable.

These “IT-convergent” DAS solutions can even share a common infrastructure with other IT applications, such as Wi-Fi, security systems and so forth. CommScope offers a revolutionary DAS solution that employs this technology. ION-E® is a simplified, streamlined DAS solution that puts powerful indoor wireless coverage within reach of smaller to mid-sized enterprise environments (Figure 13.6).

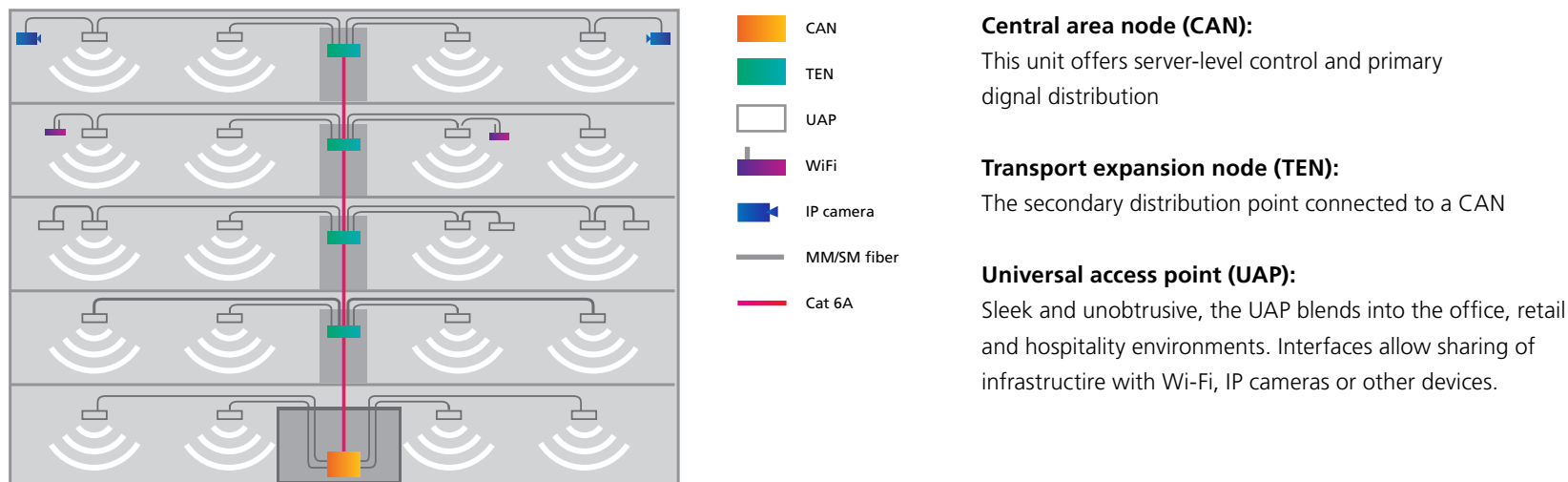

13.6: The simplified architecture of an ION-E deployment using IT structured cabling in the horizontal

13 | Extending the network indoors: DAS, C-RAN antenna systems, and small cell solutions

An example deployment reveals how ION-E® extends DAS coverage into places where traditional, coaxial-based solutions would not be practical.

Princeton University's Lewis Center for the Arts—a new, three-building complex—needed a wireless network solution to serve 139,000 square feet of classrooms, offices, and performance spaces, as well as the courtyards and common areas. The system had to support both ordinary cellular and public safety use. ION-E allowed Princeton's design and integrator partners to leverage standard Category 6A infrastructure, reducing costs and simplifying the project.

A step beyond DAS: C-RAN antenna systems

The latest DAS solutions integrate C-RAN technology, taking the IT infrastructure advantages a step further. C-RAN, which stands for centralized or cloud radio access networks, allows a DAS operator to place the network's base station head-end equipment virtually anywhere; and a single headend can service multiple buildings—even from miles away—if connected by fiber-optic cable. Service levels can be adjusted across the DAS, giving priority to traffic at a certain location or on a certain band, if desired. CommScope now offers such a solution in its Era C-RAN antenna system.

C-RAN is emerging as a game-changing innovation for two main reasons. First, it allows operators to centralize base station operations and pool hardware more

efficiently, even within their own data centers. Second, C-RAN's all-digital transport greatly reduces the amount of space and power required to operate the Era C-RAN antenna system, making DAS more economical and easier to deploy and maintain. These advantages, along with the ability to serve multiple buildings, have made extending the network indoors a practical possibility in more places than ever before.

Small cells

DAS may be the most prevalent indoor wireless technology, but it is not the only one. Small cells are another option for smaller indoor locations that can benefit from their flexible, self-contained architecture.

Small cells are what their name implies: small versions of macro cell sites—including their own base station, radio and antennas—typically combined into a single physical unit. Each small cell creates a discrete “cell” of coverage. Like macro cell sites, however, traditional small cells also create areas of overlap where their cell boundaries meet. In these areas, cellular connections suffer significant drops in service quality: reduced data rates, choppy voice, and dropped connections. This problem can be mitigated through thoughtful design and careful optimization of small cell placement and power, but it's impossible to eliminate this interference between cells entirely (until recently, that is—we will explore C-RAN, the latest small cell innovation, in the next section).



13 | Extending the network indoors: DAS, C-RAN antenna systems, and small cell solutions

Unlike DAS, which connects to an outside base station owned by a wireless operator, small cells include their own baseband unit, which must be integrated with operator networks during deployment. Wireless network operators only integrate a limited number of small cells, however, and most small cells only integrate with a single operator network. This is in contrast to DAS and its capacity to natively integrate with multiple networks.

As of this writing, most small cells support 16 to 64 users at a time, which may be adequate for many small to mid-sized enterprise environments. In addition, unlike DAS, conventional small cells cannot dynamically share capacity between access points, so large gatherings in small spaces may create bottlenecks.

C-RAN small cells

We stated in the previous section that small cells suffer from the same interference between neighboring cells that sometimes plagues the macro cell network and that concentrations of users can overwhelm individual access points. In traditional small cell architecture, this is true. However, a recent innovation from CommScope has removed this barrier from small cell deployments, making them even more attractive for deployments of the right size. This innovative approach is a C-RAN small cell.

As with the Era C-RAN antenna system described above, here the baseband unit centralizes all processing from the small cell's various radio points. In this case, however,

the result is that it creates a virtual “super cell” that combines the entire system into a single area of coverage (Figure 13.7). CommScope's C-RAN small cell OneCell can serve many hundreds of users at the same time.

This solves service quality issues and avoids dropped connections by eliminating overlap altogether. As an extra bonus, this architecture operates over conventional Ethernet switches and cabling, making it easier to install and maintain without expensive or specialized expertise. CommScope's OneCell® C-RAN small cell solution uses this technology today.

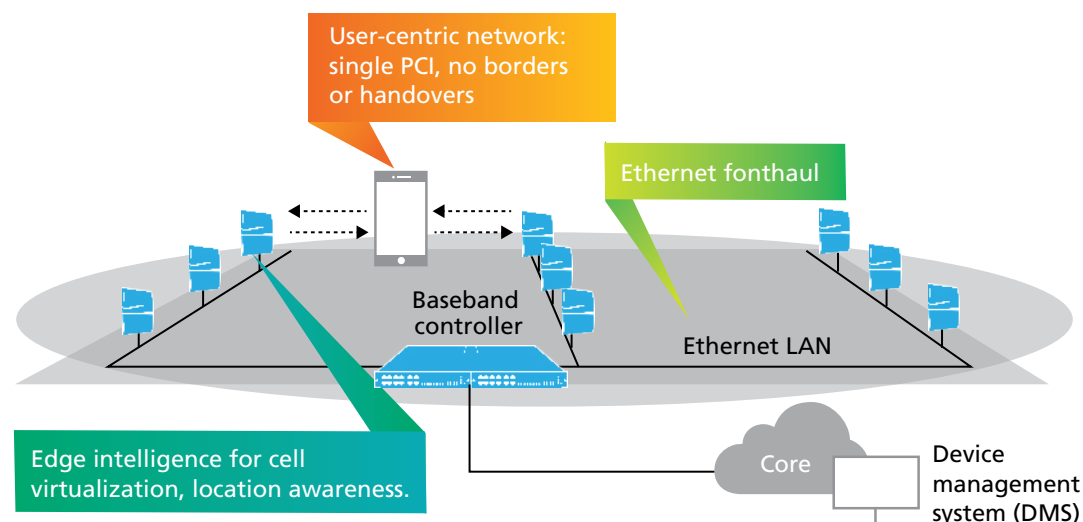

13.7: C-RAN aggregates all traffic into a single, borderless and interference-free “super cell”

13 | Extending the network indoors: DAS, C-RAN antenna systems, and small cell solutions

Indoor wireless solutions: easier, more cost-effective than ever

The realities of modern life mean wireless coverage and capacity must adapt to areas of high user density. When these areas are concentrated within buildings or campuses, DAS, C-RAN antenna systems and small cell technologies can bring the macro network beyond the walls with sufficient capacity to meet the needs of enterprise environments. Modern improvements in DAS and small cells have simplified their structures, reduced the skill set necessary to deploy and operate them, and significantly reduced the costs involved.

CommScope's own solutions in this segment, including the ION-E, Era C-RAN antenna system, and OneCell C-RAN small cell solution, provide this flexible connectivity for 100,000 fans in a packed football stadium or a few dozen dedicated employees working in a small office building. The common theme is that there are fewer hurdles to overcome than ever before, and an increasingly compelling business case to be made for DAS and small cell solutions.



Chapter 13 summary

- Indoor wireless solutions extend the macro network into buildings and campuses
- DAS is a system of antennas integrated into one or more operators' macro networks
- C-RAN antenna systems combine DAS signal distribution with a centralized or "cloud" headend for flexible baseband capacity allocation and lighter on-premise footprint
- Small cells operate like macro cells; their radios must be integrated into operator networks
- C-RAN small cells eliminate cross-border interference in small cells

Finding safer ground: Lightning protection

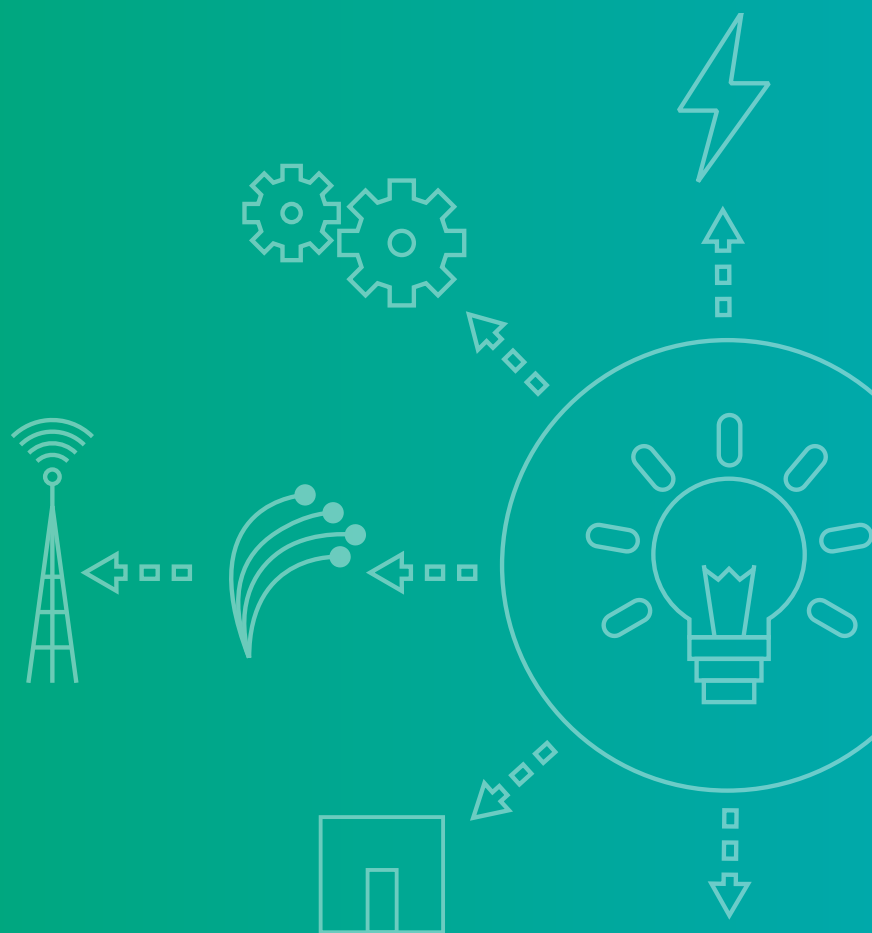

Chapter 14

Even in the 21st century, the source of atmospheric lightning is the subject of scientific debate. Different theories assign different mechanisms to the creation of lightning: wind and friction, ice formation inside clouds—even the accumulation of charged particles from solar winds.

Far better understood is the behavior and power of lightning. We've all been cautioned not to stand out in the open during a lightning storm—and for good reason. A lightning bolt can reach temperatures of 54,000 degrees Fahrenheit, five times the temperature of the Sun's surface and hot enough to fuse loose sand into hard glass in an instant. Superheated air around the bolt expands violently as it passes, creating the familiar deep rumble of thunder.

Like any electrical discharge, lightning follows the immutable laws of physics and always seeks the path of least resistance to the ground. Often, this is through the tallest or most electrically conductive object available, which is why you don't want to stand in an open field during a storm. If your body presents the shortest path

into the earth—shaving five or six feet off the distance a bolt must travel through the air—then you become a potential (although unwilling) conductor.

But how do we deal with sensitive electronics that can't take shelter from the storm? One look at a cell site tower will tell you—by virtue of its metallic composition and height—it's a prime target for lightning strikes.

A number of components are particularly attractive to lightning, including:

- Antennas and their support structures
- Coaxial transmission lines and waveguides
- Steel buildings, cabinets and other equipment enclosures
- Connected communication and power lines

This exposure opens up the installation to expensive damage, maintenance and downtime, so it's vitally important that we take protective measures to minimize the risk of lightning damage.



Understanding the risks

Unfortunately for planners, most of the risk factors for lightning strikes are the same characteristics that make for a good cell site: open land and high elevation. Since there is little that can be done about location, lightning mitigation efforts must be directed elsewhere. Let's look first at the two types of meteorological events that present the greatest risks:

- Convection storms are caused by the heating of air near the ground and its interaction with cooler air above. These create the localized, short-lived storms we see most often in the summer months.
- Frontal storms are created by warm and cool fronts meeting. These storms can extend hundreds of miles and regenerate their strength over and over again, allowing them to persist for days and affect enormous areas. Frontal storms present the greater lightning risk.

The overall pattern of these storm types can be generally anticipated by season and location. Historical trends are accurate predictors of future activity. While government statistics don't include specific numbers regarding the number or severity of lightning strikes, they do provide overall counts of thunderstorm days in a given area (Figure 14.1).

The nature of lightning

Lightning occurs in two common forms:

- Cloud-to-cloud lightning discharges itself by equalizing its charge with another cloud, remaining high above the ground in the process.
- Cloud-to-ground lightning seeks discharge through the earth. This is the kind that creates problems for objects on the ground, including cell sites.

Some shocking figures

Within 30 microseconds, an average lightning bolt's peak discharge can deliver:

- 30,000 amperes of current
- 1 trillion watts of electricity
- 500 megajoules of energy

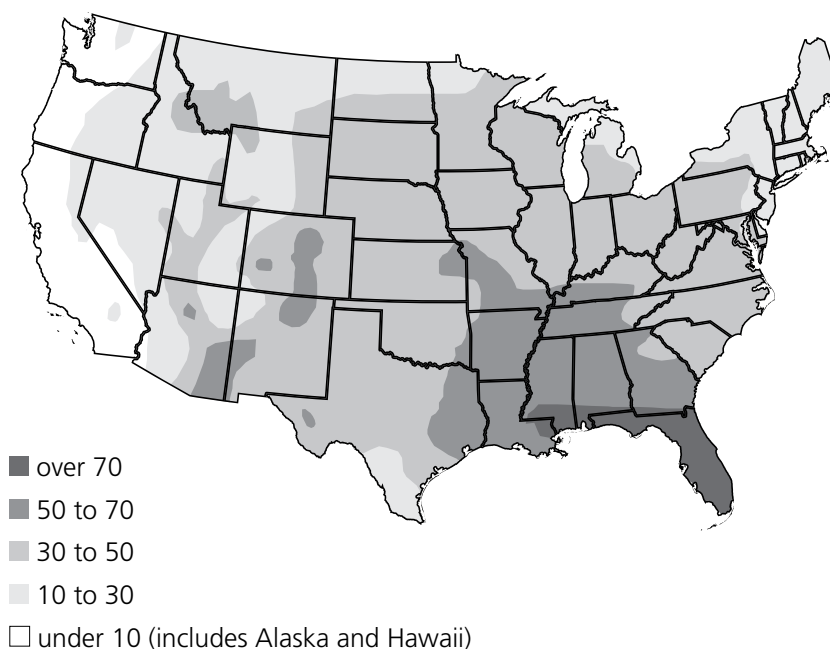

14.1: A meteorological map showing the annual number of thunderstorm days

In both cases, the lightning occurs when a difference in electrical charge—the electrical potential—exists. When this difference grows to a magnitude that overcomes the natural insulating properties of the air, the electrical difference seeks equilibrium by discharging itself along the path of least electrical resistance. For cloud-to-ground lightning, the less distance traveled in the air, the easier it is to discharge—that’s why it seeks a more conductive object on the ground as its preferred path since air is, by nature, a poor conductor.

In most cases, this discharge represents a negative charge seeking a positive charge and may represent an electrical potential of as much as 100 million volts.

The birth of a bolt

As we can see in the three-step illustration below, cloud-to-ground lightning begins as a faint or invisible “pilot leader” high in the cloud. As it progresses downward, it establishes the first phase of the strike path. This pilot leader is followed by the “step leader,” a surge in current following the new path. The step leader jumps in roughly 100-foot increments, or steps, until it approaches the positively charged point on the ground.

At this point, something incredible happens: a secondary discharge extends upwards from the ground, meeting the bolt in midair and completing the circuit. It happens so fast that the human eye sees only the bolt descending from the sky, not the one reaching up from the ground (Figure 14.2).

Electrical potential

Measured in volts, this is the difference in electrical charge between two points in space. The greater the difference, the higher the potential and the greater the voltage.

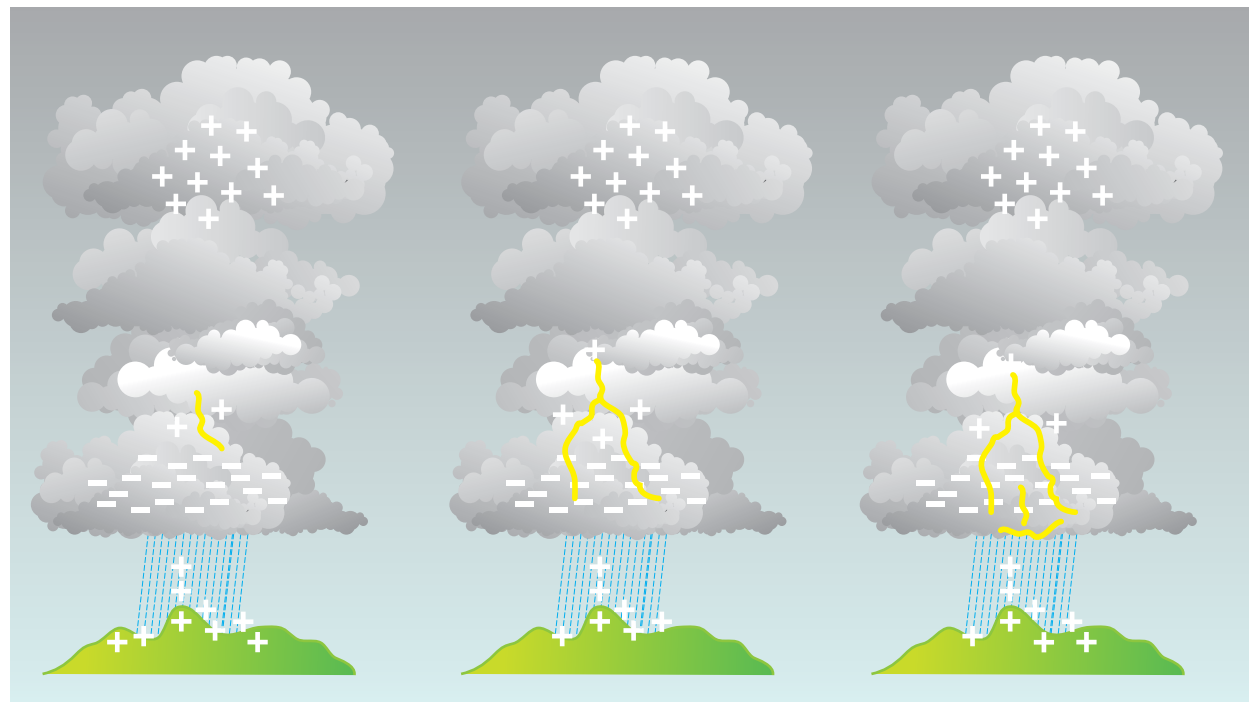

14.2: The origination and path of a cloud-to-ground strike

The intense light of a lightning bolt is created by molecules of air energized by the current passing through them. The shape of the visible lightning can help you identify its type:

- **Streak lightning** is the most commonly seen type, characterized by a single line running from cloud to cloud or from cloud to ground.
- **Forked lightning** reveals the full conductive channel as smaller tributaries branching off the main line.
- **Sheet lightning** is a shapeless, wide-area illumination commonly seen in cloud-to-cloud discharges.
- **Ribbon lightning** is a streak that seems to repeat itself in a parallel path. This is due to high winds moving the air in the midst of the strike.
- **Beaded lightning**, also called chain lightning, appears to break up into separate branches and persist longer than the main strike.
- **Heat lightning** is not truly a lightning type, but the red-tinted appearance of other lightning types visible on a distant horizon. The coloration is due to atmospheric reflections and light scattering between the lightning and the observer.

Dealing with lightning

Now that we understand the power of lightning, its behavior and its many forms, we are able to consider ways to prevent its catastrophic effects on RF infrastructure such as antennas and coaxial transmission lines.

All electrical facilities are inherently connected to the ground—either by design or by circumstance. The earth itself represents the common electrical potential, or voltage, that all other electrical sources naturally seek to achieve equilibrium. By improving the way these discharges reach the earth, we can control the path and divert its damaging power away from equipment and structures that would otherwise be harmed or destroyed by such current passing through them.

When you imagine an electrical grounding system, you may picture a simple lightning rod wired into a connection in the ground. Such an arrangement may be adequate for a home; but, for a cell site, the grounding system is much more complex and serves other purposes in addition to lightning protection. Remember that many components on a cell tower are themselves powered; grounding must also protect workers from the hazards presented by the line current in these active components. In addition, these components contain sensitive electronics that are susceptible to noisy voltages that may be found in poor electrical connections.

Coaxial cable

A type of cable featuring an inner conductive core, an outer conductive layer and a dielectric (or insulating) space between them.

Grounding limits

As important as effective grounding is, it's often not enough by itself. Any path you install to ground a discharge has a certain physical limit to the voltage it can handle. Even the most substantial methods, like water pipes and specially designed grounding rods, are restricted as to how much voltage they can pass to the ground. To address these limits, it's wise to design in multiple paths so the grounding system can dissipate the most voltage possible.

Protecting the tower

The antenna tower presents the most obvious electrical target, as well as the best opportunity to protect the rest of the installation. That's because drawing lightning to the tower for safe discharge also gains us valuable insurance for the harder-to-protect components down on the ground and those connected by transmission lines.

By its very nature, a tall metallic tower can conduct lightning current into the ground very effectively. The danger arises when the voltage exceeds the structure's ability to dissipate it, resulting in electrical arcing. This current can damage antennas and—in particularly powerful strikes—fuse the dipole elements, destroying them.

To protect these and other components mounted on metallic towers, lightning rods should be affixed directly to the tower above the mounted components to assure safe interception of a strike. It's also important to ensure that the tower's base, footings and any guy wires are also properly grounded.

Additional protective measures include insulating gaps built into the design and devices called "shorting stubs" that can be added to allow a short circuit at lightning's natural (and predictable) frequencies. We'll explore these measures later in this chapter.



Grounding

Measures taken to control and facilitate the path of an electrical discharge from its source to the ground, potentially avoiding damage to sensitive equipment along the way. Cell sites require complex grounding to protect from lightning and other electrical hazards to equipment and personnel.

Wooden tower structures

In wooden structures, conductive paths must be added to give strikes a direct route to the ground. If wooden support poles provide a nonconductive obstacle from a metal tower, effectively insulating it from the ground, then additional lightning rods should be affixed atop these poles. This is because lightning passing through low-conductivity materials like wood causes immense heat that can split or even explode the material. Should this occur to wooden poles holding up a cell tower, the entire structure is at risk of catastrophic collapse.

Rods for this kind of application are typically #6 AWG bare copper, stapled to the pole on the side opposite the antenna's transmission line. This ground line should be connected to all equipment on top of the pole as well as any lines leading away to a connected shed or cabinet (Figure 14.3).

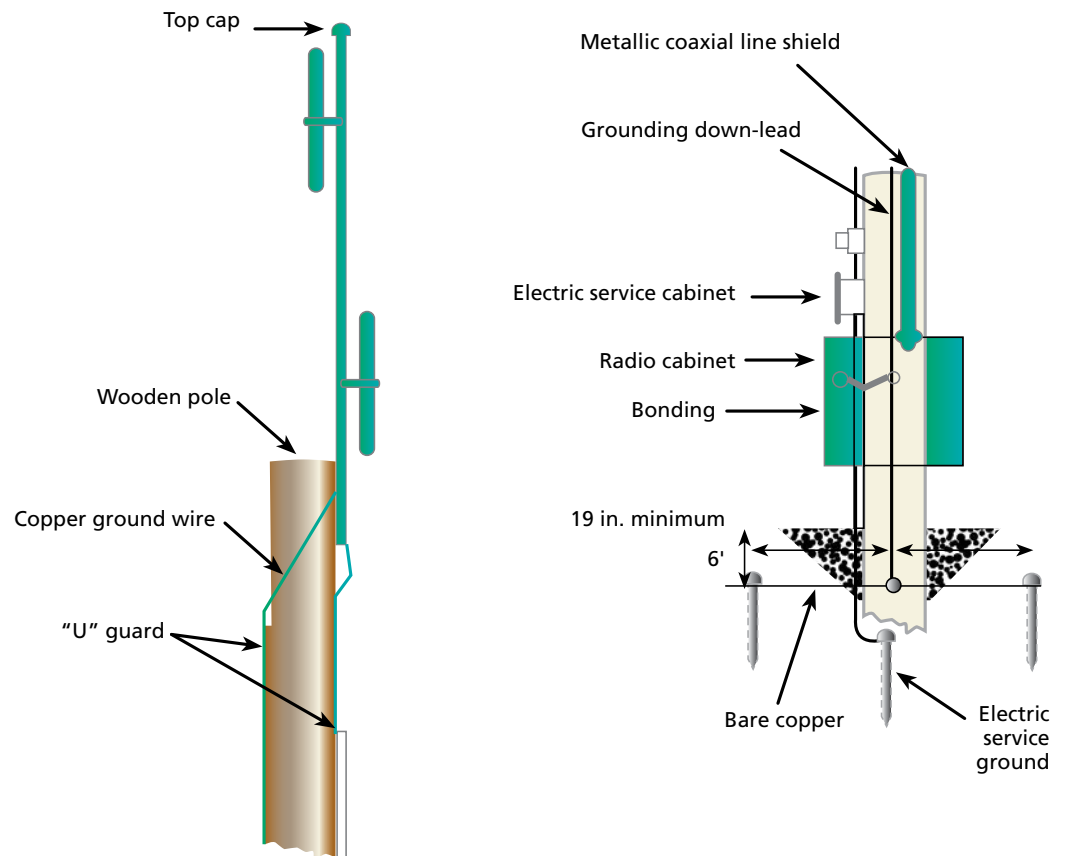

14.3: Grounding details for a wooden pole-mounted antenna

Two-way radio antennas

Conventional coaxial dipole antennas are often fitted with a serrated washer that forms a physical gap between the dipole whip and its support. Should lightning strike this point, the gaps in the serrated washer force the current to arc across the open space—creating a short circuit and dissipating the discharge.

Another protective measure is the insertion of a quarter-wave shorting stub in the coaxial transmission line at the base of the antenna. They're called "quarter-wave shorting stubs" because their place in the circuit does not impact normal operating frequencies of the site, and their length (a quarter of one wavelength) will cause an immediate short circuit for electrical frequencies associated with lightning.

By doing this, they act as a sort of electrical "release valve" that will divert only a certain kind of dangerous current away from the system.

Base station antennas tend to have built-in protection (see Chapter 3 for more information on different antenna configurations). These types are generally constructed of materials capable of handling most near strikes, and their transmission lines are adequately shielded to direct any lightning current to the ground following other, easier paths.

Microwave antennas

Some cell sites host microwave antennas, which are sometimes used for backhaul purposes—that is, transmitting aggregated site traffic via a line-of-sight beam to a distant receiver antenna in order to move traffic on and off the core network. Because they use thin, direct beams to create links that can cover many miles, they are often mounted high on a tower.

Common types of microwave antennas, such as the paraboloid (dish-shaped) and horn reflector varieties, are generally rugged enough to sustain normal lightning strikes without damage. However, the warning lights visible atop these installations are not so durable. To protect these regulatory-mandated devices, lightning rods are used to divert lightning discharges away from their more delicate wiring.

These protective systems may seem like a lot of expense to protect what are, essentially, just blinking red lights. However, the labor involved in replacing them after a lightning storm quickly becomes a costly maintenance situation.

Two-way radio antenna support structures

The buried end of a ground line can take several forms. Ideally, you would want the buried end to extend deep into the earth—providing a more reliable interface for dissipating the voltage. In some locations, such as rocky mountaintops, these depths

Quarter-wave shorting stub

A device inserted into the connection between transmission line and antenna that does not affect normal operational frequencies, but will immediately short—and dissipate current—when lightning frequencies cross it.

aren't available. In these cases, the support structure can be protected by laying in multiple ground lines in a radial pattern to achieve horizontally what a single deep line would achieve vertically.

Rooftop sites

Rooftop installations are becoming more common as operators expand their network coverage and capacity in high-population, high-density locations. Macro cell sites—and miniaturized versions built to meet zoning and appearance standards—are appearing on urban rooftops all over the world; yet, even in crowded spaces where taller objects are located nearby, lightning remains a significant threat.

For these installations, all equipment, transmission lines and other conductive objects within a six-foot radius of the base should be commonly connected. The entire array should attach to a separate conductor with a minimum of two conductor systems integrated into the building itself. These conductors may be water pipes, steel framing or other electrically sturdy materials having direct contact with the ground below.

For those antenna structures mounted on metallic towers, grounding is a much simpler matter, since the tower structure itself provides a clear path to ground in the event of a lightning strike. Of course, this all depends on properly grounded base supports. Four methods of assuring this effect are shown to the right (Figures 14.4 through 14.7).

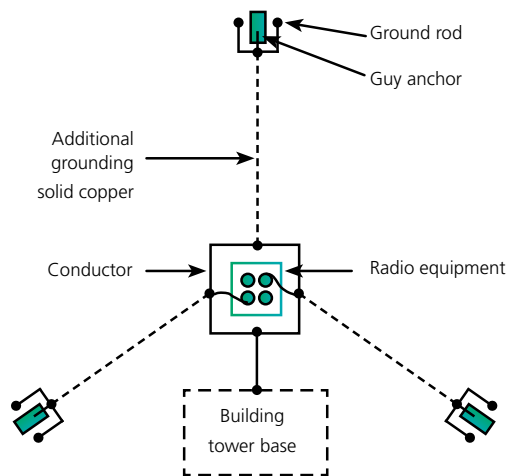

14.4: Support grounding installed in a tower pier

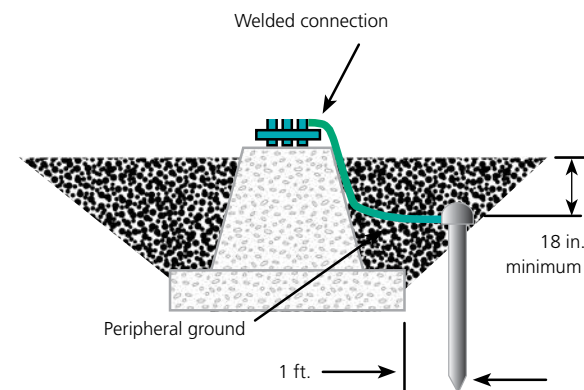

14.5: Support grounding achieved via guy wires

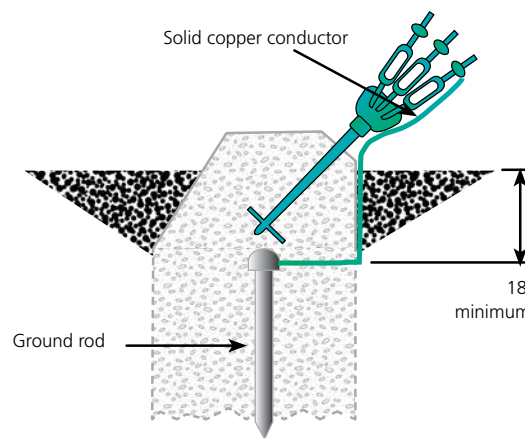

14.6: Support grounding installed in a tower's guy wire anchors

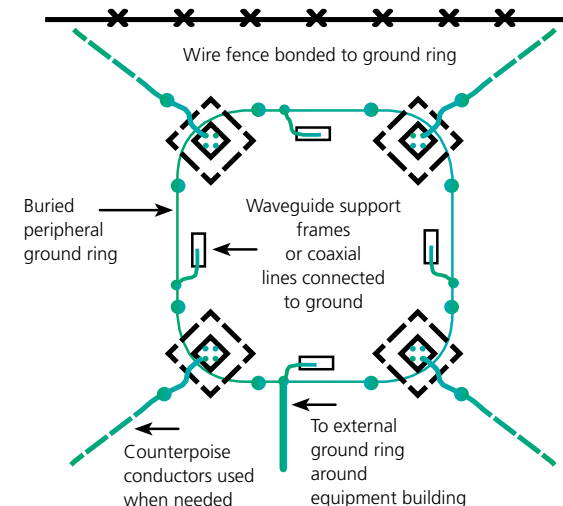

14.7: Support grounding for a freestanding tower structure

For ground lines terminating through concrete bases and guy wire anchors, good conductive continuity inside the concrete itself should be virtually immune to any negative effects from lightning strikes. This is true for towers built on the ground as well as structures installed on top of buildings.

However, inadequate welds within the concrete may lead to electrical discontinuity, which can cause electrical arcing within the support...with potentially explosive results. For maximum safety, a secondary ground line is highly recommended.

Coaxial transmission lines and surge protection devices (SPDs)

Coaxial cables are subject to potential hazards from surge currents reaching the inner conductors and outer conductor layer. Damage to the insulating dielectric layer between the inner and outer conductors can result from a lightning strike, which may destroy the cable and, more importantly, damage expensive radio equipment connected to it. Examples of these surge protection devices (SPDs) are shown in Figure 14.8.

Surge arrestors protect the radio equipment by taking the energy from a strike off of the inner conductor of the cable, shunting the energy to ground, typically via a quarter-wave stub that ultimately connects to a copper ground wire attached to a threaded rod on the surge arrestor on one end, leading to a grounding point on

the tower or support structure on the other end. Quarter-wave stub-type arrestors are available in dc blocking versions, and also dc passing versions that allow tower-top equipment to be powered via the cable's inner conductor.

Gas tube surge arrestors are another form of protection (Figure 14.9). These devices ground the inner conductor of the cable, but utilize a small gas tube, which acts as a fuse, shorting the path of the strike when the gas tube is energized. These types of arrestors typically withstand only one large strike, then need to be replaced—while quarter-wave stub surge arrestors can withstand multiple strikes without a need to service the arrestor.



14.8: Typical surge protection devices (SPDs)



14.9: A gas tube surge arrestor used to ground the inner conductive layer

Dielectric layer

The insulated, tube-shaped layer separating a coaxial cable's inner and outer conductors. Dielectrics may be made of solid material, flexible foam, or open air channels supported by nonconductive spacers. If the dielectric becomes damaged, the cable may short.

14 | Finding safer ground: Lightning protection

Mechanical crush forces are also associated with surge currents. While solid dielectric and larger cables (7/8 in. and up) are resistant to this effect, air dielectric and smaller-diameter cables have been known to be physically crushed by the magnetic effects of lightning-induced surges. Providing a shunt path from the antenna to the ground line will usually prevent both kinds of damage. This danger highlights the rationale

for securing the cables at such frequent intervals—to prevent arcing between cable and tower.

SPDs are used to safeguard all cell site components connected to the dc power system, but any devices connected to an external metallic conductor will require separate protection.

The most vulnerable components connected to the dc power system are remote radio heads (RRHs). Mounted as they are atop the cell site's tower and adjacent to the antenna, the RRH and its copper power cable are natural targets for lightning—much like the power distribution equipment at the tower's base. Insertion of SPDs as close as possible to these locations protects the RRH units from overvoltage damage (Figures 14.10 and 14.11).

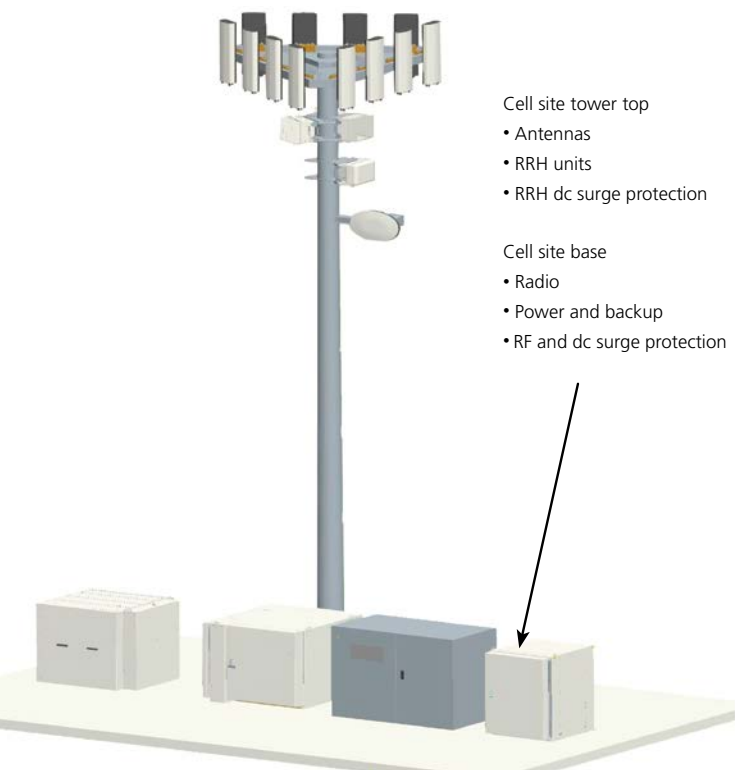

14.10: Vulnerable components at the top and base of a cell tower

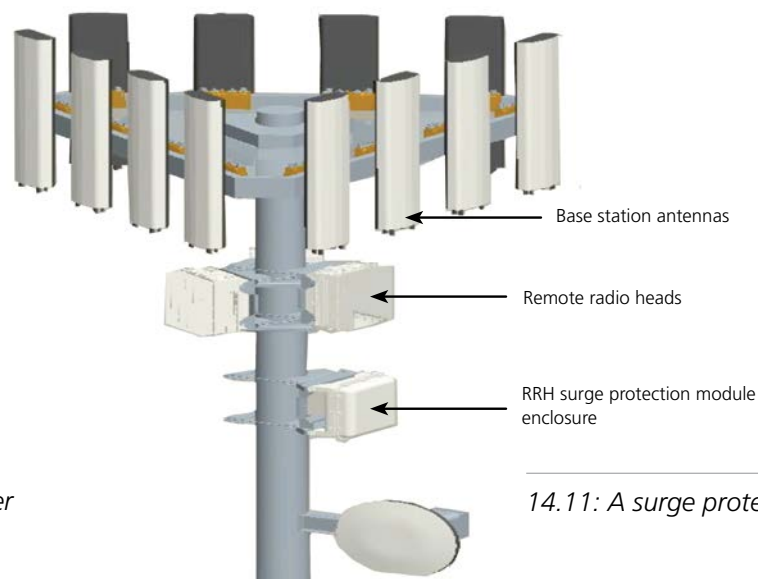

14.11: A surge protector mounted alongside the RRH

14 | Finding safer ground: Lightning protection

An SPD capable of withstanding multiple lightning strikes must possess a robust resiliency to avoid costly maintenance and downtime for replacement. A detailed look at the inner layout of a sample RRH surge protection module appears below (Figure 14.12).

Equipment at the base of the tower requires protection as well. Key components like the radio, the transmitter and backup battery systems—visible at the bottom of Figure 14.10—are all vulnerable to damage from

lightning-induced overvoltage. To prevent this, rack-mounted SPD units safeguard the power distribution system's connections between the RRH power cables and the rest of the equipment installed at the base (Figures 14.13 and 14.14).

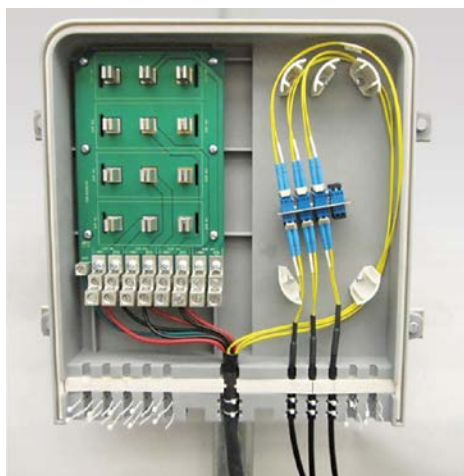

14.12: Inside an RRH surge protector module, cover removed



14.13: An SPD assembly mounted in a dc power and battery enclosure

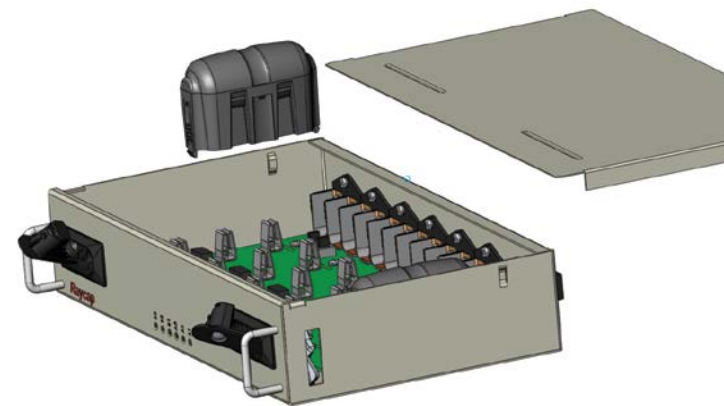

14.14: The interior detail of an SPD unit designed to protect an RRH

Other forms of overvoltage protection: fuses and breakers

SPDs serve functions other than simply protecting components from lightning strike-induced overvoltage situations. As we learned in Chapter 11, SPDs also offer protection in the form of fuses and circuit breakers that keep more common forms of overvoltage from damaging components and batteries.

In a cell site's dc power distribution system, as many as 80 circuit breakers may regulate dc power from the rectifier to all the connected loads—both in the enclosure and on the tower (Figure 14.15).

Both fuses and circuit breakers perform the same basic function, which is to interrupt power to the load when levels grow unsafe. Examples of each are shown below (Figure 14.16).

- **Fuses** incorporate conductors designed to melt under the stress of overcurrent conditions—breaking the circuit and protecting the load on the other end.
- **Circuit breakers** incorporate short-delay curve or “fast-blow” fuses to break the circuit and protect the load.

Because of the large number of circuit breakers required—often from 24 to 80 per cell site—wireless carriers have adopted modular distribution structures that accept a wide variety of circuit breaker sizes. You can learn more about these features in Chapter 11.

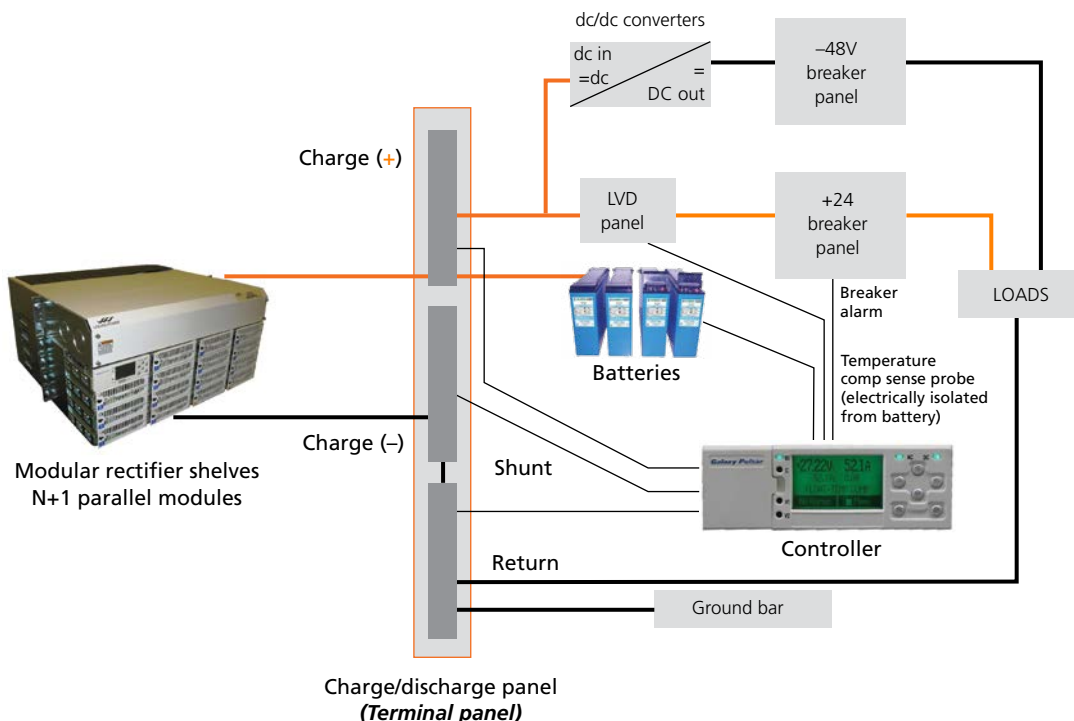

14.15: Block diagram of +24V power and distribution system, typical of a cell site installation
Images and illustration courtesy of GE.



14.16: Commonly used telecom fuses and circuit breakers

Taming lightning by controlling the current

No matter how many times we witness it, the incredible power of a lightning bolt can instill fear and awe. When lightning strikes exposed cellular installations, only careful planning can divert its devastating power away from the sensitive components that keep modern networks operating.

With the right components, design and experience, a cell site can become virtually immune to the damaging effects of lightning—as well as other electrically dangerous situations. CommScope supplies networks with the solutions and expertise to bring the threat of lightning under control so networks can continue to operate seamlessly—in all kinds of weather.

Chapter 14 summary

Lightning protection

- Lightning seeks the path of least resistance to the ground
- Providing safe paths around sensitive equipment protects cell sites

Lightning types:

- Cloud-to-cloud
- Cloud-to-ground

Grounding an installation:

- Metal towers can be self-grounding
- Wooden structures require paths
- Ground wires can travel deep or radiate horizontally

Vulnerable tower and base station equipment:

- Remote radio heads (RRHs)
- Power distribution lines
- Radio, transmitter, battery backups

Measures to protect dc power systems:

- Surge protection devices
- Fuses and circuit breakers

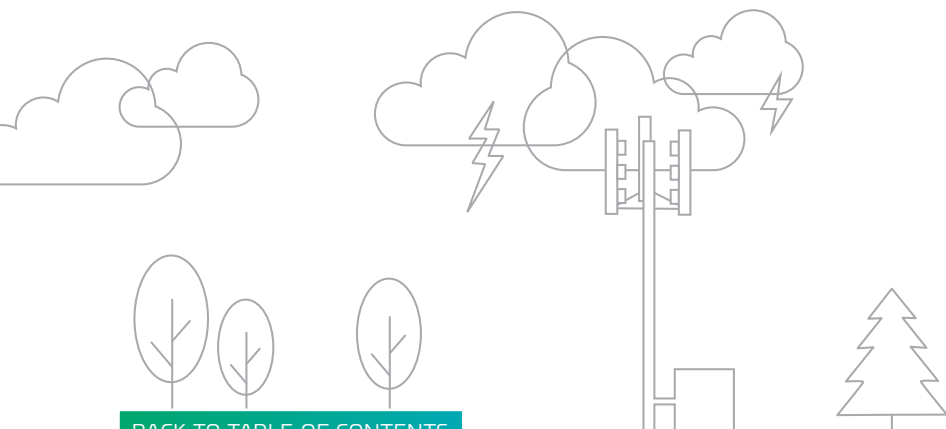

Baber Abbas

Baber Abbas is director, product line HELIAX® products at CommScope, responsible for connectivity solutions for the telecommunications carrier market both from the coaxial and fiber perspective. In his more than 15 years of work experience, Baber has held several leadership positions in product line, sales, business development and engineering at CommScope. He holds a bachelor of science degree in electrical engineering from Pakistan and a Master of Business Administration degree from the University of Chicago.

Ray Butler

Ray Butler is vice president of Mobility Network Engineering at CommScope, responsible for wireless technical sales leadership in outdoor RF products. Before, Ray led the R&D team responsible for base station antennas, filters, combiners, remote radio heads and RF power amplifiers. He previously worked for Andrew Corporation as vice president of Base Station Antennas Engineering as well as Systems Engineering and Solutions Marketing. He has served as director of National RF Engineering with AT&T Wireless and vice president of Engineering, Research and Development, and International Operations at Metawave

Communications, a smart antenna company. Ray was technical manager of Systems Engineering for Lucent Technologies Bell Laboratories, having also held other management positions responsible for the design of RF circuits, filters and amplifiers. Ray holds a Bachelor of Science degree in electrical engineering from Brigham Young University and a Master of Science in electrical engineering from Polytechnic University, and is a member of national engineering honor societies Eta Kappa Nu and Tau Beta Pi.

Tom Craft

Tom is an engineering director for the Site Solution business unit and is responsible for technical strategy. He has spent his career creating innovative solutions for next-generation information and communication technologies. He was a member of technical staff at AT&T/Lucent Technologies Bell Laboratories developing products for light wave device packaging, military submarine and ship-based electronics, and digital loop carrier businesses. Since joining CommScope in 2007, he has worked to develop emerging technologies in the areas of fuel cell backup power systems and modular datacenters. Currently, Tom is working to develop systems to enable the implementation of a reliable and converged 4G and 5G network. He holds 15 U.S. patents and has a masters degree in mechanical engineering from the New Jersey Institute of Technology. He is based in Richardson, Texas.

Jeff Epstein

Jeff Epstein is the strategic and portfolio marketing manager for CommScope's outdoor wireless solutions. Previously, Jeff worked in software development and product management for Ericsson and product and solution marketing for Intervoice and Convergys. He has been in the telecommunications industry for over 20 years and has authored numerous white papers, journal articles and blog posts. Jeff holds a Master of Science degree in computer science.

Mike Fabbri

Mike Fabbri is vice president of Site Solutions and Services for CommScope, responsible for the development and integration of RF site solutions, including metro cell for the telecommunications carrier market. In his more than 25 years of work experience, Mike has held several leadership positions in product line, sales, marketing and business development at Motorola, ARDIS and Motient. He holds a Bachelor of Science degree in electrical engineering from the University of Illinois Urbana-Champaign and a Master of Business Administration degree from the University of Chicago.

Donald Gardner

Donald Gardner is a product line manager within the Microwave Antenna Systems team at CommScope and is based in Lochgelly, Scotland. Holding a Master of Engineering degree from the University of Strathclyde and a Master of Business Administration from the University of Edinburgh, he has been involved in the wireless communications industry for over 20 years. Prior to his current position, Gardner held various positions in quality and engineering within our microwave antenna group. His key expertise includes mechanical and process engineering of microwave antennas and product management of microwave backhaul solutions.

John Hanley

John Hanley is director of Commercial Strategies for CommScope, responsible for supporting efforts to market Power products for CommScope on a global basis—with particular emphasis on the PowerShift product. John has been with Andrew/CommScope since 1977 with various technical and marketing positions in the Satellite Antenna, DAS and Cellular products. John holds a Master of Science degree from Northern Illinois University and is based in Joliet, IL.

Mark Hendrix, P.E.

Mark is engineering director, Enclosure Solutions, responsible for directing innovation efforts in wireless communications enclosure systems for CommScope, with particular focus on thermal design, power systems and other efficiency drivers. He brings 30-plus years of expertise in electronic packaging, with backgrounds in both defense electronics and telecommunications for such names as Texas Instruments, Fujitsu and Xtera Communications. Mark holds 12 U.S. patents and is a registered professional engineer in the state of Texas. He holds a Bachelor of Science degree in mechanical engineering from Clemson University, and a Master of Science degree in mechanical engineering from Southern Methodist University.

Erik Lilieholm

Erik Lilieholm is technical sales manager, Mobility Network Engineering. Erik's diverse background in North America's wireless communications industry dates back to the launch of the first cellular communications networks. He has built his expertise with Allen Telecom, LGP Telecom and Ericsson. With over 25 years in RF design, product management and technical marketing, Erik provides critical leadership to CommScope's families of wireless network solutions—helping customers fulfill their present needs and future visions. He holds several patents in the field of wireless technology. Erik earned a Master of Science degree in electrical engineering from the Royal Institute of Technology in Stockholm, Sweden, and a Master of Business Administration from the University of Nevada, Reno.

Matt Melester

Matt Melester is senior vice president and general manager, Distributed Coverage and Capacity Solutions, at CommScope. He and his team are responsible for CommScope's distributed antenna systems and in-building small cell solutions, including successfully enhancing wireless coverage and capacity at numerous high-profile locations and events, including the FIFA World Cups in Germany and South Africa; Olympics venues in Sydney, Beijing, London and others; high-speed rail systems in Italy, Germany, China and more; the world's longest tunnel in Switzerland; the world's tallest building in Dubai; and the world's largest indoor stadium. Matt has over 35 years of experience in the telecommunications industry at CommScope, Andrew Corporation, Chrysler Technologies Airborne Systems and Texas Instruments. He has a master's degree in electrical engineering from the University of Kentucky.

Louis Meyer

Louis Meyer, P.E., is director of technical sales for CommScope Mobility Solutions. Lou has spent a lifetime advancing RF technology, taking it from the drawing board to practical use. Over the years—in various roles with Allen Telecom, Andrew Ltd. and CommScope—Lou has been responsible for supporting the sales teams for such solutions as remote antenna control systems, transmission lines, diplexers and other important components. Prior to joining Allen Telecom, Lou worked with Decibel Products as vice president of Antenna Design and vice president of International OEM Relations. Earlier, Lou worked with Harris Corporation in RF communications and Bendix Corporation in their Missile Systems division. Lou holds 10 patents and was previously chair and vice-chair of the TIA's TR-8.11 Antenna Standards subcommittee. He earned his Bachelor of Science degree in electrical engineering from Marquette University in Milwaukee, Wisconsin, and is currently a registered professional engineer in the state of Texas.

Mohamed Nadder Hamdy

Dr. Mohamed Nadder Hamdy joined CommScope back in 2015 as the director of Mobility Network Engineering. He provides technical expertise to the Middle East and Africa operators and OEMs, aiming to optimize RAN architectures, for cost and performance, with innovative products.

From 1997 to 2015, Mohamed was with the Emirates Telecommunications Corporation (Etisalat), holding senior roles across the United Arab Emirates, Egypt, and Nigeria—including as CTO in Etisalat Nigeria, head of Mobile Network Capacity Planning (then Mobile Technology Strategy) in Etisalat UAE, and regional radio planning manager in Etisalat Egypt. He holds Ph.D., Master of Science, and Bachelor of Science degrees in electrical communications engineering from Alexandria University (Egypt) dated 2012, 2002 and 1994, respectively.

Wes Oxlee

Wes Oxlee is director of Business Development and Strategy for the CommScope Connectivity Solutions business unit. Wes has 34 years of telecommunications industry experience with a primary focus on optical fiber external plant networks. Following a 16-year career with Telstra, where he was the national technical specialist for Fiber Optics External Plant, he joined CommScope in 2000. Wes is a certified fiber-to-the-home professional and, in his current role, he is focused on developing innovative fiber solutions and architectures that will support the next-generation wireless networks.

Gerry Reynolds

Gerry Reynolds is director, global reliability (WNS) for CommScope, with responsibility for reliability and qualification product testing as well as resources for failure mode analysis (FMA). His team performs various reliability analyses and environmental/reliability testing with lab and personnel resources in North America, China, India, and Europe. Prior to CommScope, he worked in hardware integration for wireless base stations at Lucent Technologies and national field support for Siemens Medical Systems. Mr. Reynolds holds a bachelor of science degree in electrical engineering from Rutgers University and a master of science degree in electrical engineering from the New Jersey Institute of Technology.

Martin Zimmerman

Marty Zimmerman is an engineering fellow and leads the antenna solutions team for base station antennas at CommScope, responsible for driving the development of next-generation antenna products based on collaborations with key customers. Other duties include managing the IP portfolio and providing technical guidance on M&A activities. Previously, Marty served as director of Engineering and senior principal antenna engineer for the same team. Prior to that, he worked as an antenna engineer for Sinclair Technologies and Analex, a NASA contractor. Marty holds 28 U.S. and numerous foreign patents in addition to having been published in several journals. He has a Bachelor of Science in electrical engineering from California Institute of Technology and a master's degree and Ph.D. in electrical engineering from University of Illinois, Urbana-Champaign.

Appendix A: Spectrum configurations around the world

Region	Countries	Frequency bands	Applicable technologies*				
			GSM	CDMA	UMTS	FD-LTE	TD-LTE
Americas, Europe, Asia Pacific	Brazil, Cambodia, Indonesia, Laos, Czech Republic, Denmark, Latvia, Malaysia, Mongolia, Myanmar, Norway, Philippines, Russia, Vietnam	450 MHz		✓			
Asia Pacific	Thailand	470 MHz		✓			
Oceania, Asia Pacific, Americas, Europe	Australia, Canada, Chile, France, Germany, New Zealand, Taiwan	700 MHz				✓	
Americas	Peru, Turks and Caicos Islands, USA	700 MHz		✓			
Americas	Trinidad and Tobago	700 MHz					
Asia Pacific	Australia	800 MHz	✓			✓	
Europe, Asia Pacific	Austria, Finland, Macedonia, Nepal	800 MHz		✓			
Europe, Africa	Belgium, Croatia, Czech Republic, Denmark, Estonia, France, Germany, Greece, Hungary, Iceland, Ireland, Italy, Latvia, Luxembourg, Netherlands, Nigeria, Norway, Portugal, Romania, Russia, Senegal, Slovakia, Spain, Sweden, Switzerland, Tanzania, Turkey, United Kingdom	800 MHz				✓	
Asia Pacific, Americas	Afghanistan, Argentina, Bangladesh, Cambodia, China, India, Macau, Malaysia, Mexico, Mongolia, Papua New Guinea, Taiwan, United States, Vietnam	850 MHz		✓			
Americas	Bahamas, Bolivia, Chile, Peru, Trinidad and Tobago	850 MHz	✓				
Asia Pacific	Bhutan, New Zealand	850 MHz			✓		
Americas	Brazil, Canada, Venezuela	850 MHz	✓	✓			
Asia Pacific	Hong Kong	850 MHz		✓	✓		
Asia Pacific	Indonesia	850 MHz		✓		✓	
Asia Pacific	Japan	850 MHz		✓	✓	✓	
Asia Pacific	South Korea	850 MHz				✓	

Appendix A: Spectrum configurations around the world

Region	Countries	Frequency bands	Applicable technologies*				
			GSM	CDMA	UMTS	FD-LTE	TD-LTE
Americas	Turks and Caicos Islands	850 MHz	✓		✓		
Asia Pacific, Europe, Middle East, Americas, Africa	Afghanistan, Albania, Austria, Azerbaijan, Bahrain, Bangladesh, Belarus, Bhutan, Bosnia & Herzegovina, Botswana, Brazil, Brunei, Bulgaria, Cambodia, China, Cypress, Denmark, French Guiana, Georgia, Germany, Ghana, Guadeloupe, Hungary, India, Ireland, Italy, Kazakhstan, Kenya, Laos, Latvia, Lithuania, Luxembourg, Macau, Macedonia, Malta, Martinique, Micronesia, Moldova, Mongolia, Morocco, Myanmar, Namibia, Nepal, Netherlands, Nigeria, Oman, Pakistan, Palau, Papua New Guinea, Poland, Qatar, Romania, Russia, Saudi Arabia, Senegal, Serbia, Singapore, Slovakia, Slovenia, South Africa, Spain, Sri Lanka, Taiwan, Tonga, Tunisia, Turks and Caicos Islands, Uganda, Venezuela, Vietnam	900 MHz	✓				
Europe, Asia Pacific, Africa	Belgium, Croatia, Estonia, Finland, France, Iceland, Malaysia, Montenegro, Norway, Philippines, Sweden, Switzerland, Turkey, United Kingdom	900 MHz	✓	✓			
Europe, Americas, Asia Pacific	Czech Republic, Peru, Thailand	900 MHz		✓			
Asia Pacific, Middle East, Oceania	Hong Kong, Iran, New Zealand	900 MHz	✓		✓		
Asia Pacific	Indonesia	900 MHz	✓		✓	✓	
Asia Pacific	Japan	900 MHz			✓	✓	
Asia Pacific	South Korea	900 MHz				✓	
Europe	Germany, Italy, United Kingdom	L-Band				✓	
Europe	Slovenia	L-Band				✓	✓
Americas	United States, Canada	AWS-1		✓			
Americas	United States, Canada	AWS-2		✓			
Americas	United States, Canada	AWS-3		✓			

Appendix A: Spectrum configurations around the world

Region	Countries	Frequency bands	Applicable technologies*				
			GSM	CDMA	UMTS	FD-LTE	TD-LTE
Asia Pacific, Europe, Middle East, Americas, Africa	Afghanistan, Albania, Austria, Azerbaijan, Bahrain, Bangladesh, Belarus, Belgium, Bosnia & Herzegovina, Brazil, Cambodia, Cypress, Czech Republic, Denmark, France, Georgia, Germany, Greece, Guadeloupe, Hong Kong, India, Kenya, Latvia, Lithuania, Luxembourg, Macau, Macedonia, Malta, Nepal, Nigeria, Oman, Pakistan, Palau, Papua New Guinea, Philippines, Poland, Saudi Arabia, Senegal, Serbia, Slovakia, Slovenia, South Africa, Spain, Sweden, Taiwan, Thailand, Tunisia, Vietnam	1800 MHz	✓				
Asia Pacific	Bhutan, Brunei, Indonesia, Ireland, Namibia, Netherlands, New Zealand, Sri Lanka, Turkey, United Kingdom	1800 MHz	✓			✓	
Asia Pacific, Europe, Africa, Oceania	China, Croatia, Estonia, Finland, Iceland, Italy, Malaysia, Mongolia, Norway, Romania, Singapore, Switzerland	1800 MHz	✓	✓			
Middle East	Egypt	1800 MHz				✓	
Middle East	Iran	1800 MHz	✓		✓		
Asia Pacific	Japan	1800 MHz		✓	✓	✓	
Europe	Montenegro	1800 MHz		✓			
Asia Pacific	South Korea	1800 MHz		✓		✓	
Americas	Argentina, United States	1900 MHz	✓	✓			
Americas	Bahamas, Brazil, Mexico, Nigeria, Peru	1900 MHz	✓				
Americas, Asia Pacific	Canada, China, Indonesia, Mongolia	1900 MHz		✓			
Americas	Chile	1900 MHz	✓		✓		
Asia Pacific	Afghanistan	2 GHz		✓			
Europe, Africa	Albania, Algeria	2 GHz			✓		
Oceania	Australia	2 GHz	✓			✓	

Appendix A: Spectrum configurations around the world

Region	Countries	Frequency bands	Applicable technologies*				
			GSM	CDMA	UMTS	FD-LTE	TD-LTE
Europe, Middle East, Asia Pacific, Oceania, Africa, Americas	Austria, Azerbaijan, Bahrain, Bangladesh, Belgium, Bulgaria, Chile, China, Croatia, Cypress, Czech Republic, Denmark, Estonia, Finland, France, Germany, Hong Kong, Hungary, Iceland, Ireland, Italy, Japan, Latvia, Lithuania, Luxembourg, Macedonia, Malta, Morocco, Netherlands, New Zealand, Nigeria, Norway, Peru, Philippines, Poland, Romania, Russia, Saudi Arabia, Singapore, Slovakia, Slovenia, Spain, Sri Lanka, Sweden, Switzerland, Taiwan, Thailand, Turkey, Ukraine, United Kingdom	2 GHz		✓			
Europe	Belarus	2 GHz	✓				
Asia Pacific, Europe, Asia Pacific, Middle East, Africa	Bhutan, Bosnia & Herzegovina, Brunei, Cambodia, Georgia, Indonesia, Iran, Kenya, Laos, Macau, Malaysia, Mongolia, Myanmar, Namibia, Nepal, Oman, Senegal	2 GHz			✓		
Europe	Portugal	2 GHz	✓	✓			
Asia Pacific	South Korea	2 GHz			✓	✓	
Oceania, Asia Pacific, Europe, Africa	Australia, Indonesia, Latvia, Nepal, Nigeria	2.3 GHz					✓
Asia Pacific	China, Hong Kong, Thailand	2.3 GHz		✓			
Middle East	Oman	2.3 GHz					✓
Oceania, Americas, Europe, Asia Pacific, Middle East	Australia, Brazil, China, Czech Republic, France, Hong Kong, Iran, Lithuania, Luxembourg, Slovenia, South Korea, Spain	2.6 GHz				✓	
Americas, Asia Pacific	Canada, Chile, Malaysia	2.6 GHz					✓
Europe	Cyprus, Greece, Hungary, Romania, Switzerland, United Kingdom	2.6 GHz				✓	✓
Europe, Asia Pacific, Americas	Austria, Belgium, Denmark, Estonia, Finland, Germany, Italy, Montenegro, Netherlands, Norway, Portugal, Sweden, Taiwan, United States	2.6 GHz		✓			
Europe	Belarus	2.6 GHz	✓				
Europe	Latvia	2.6 GHz		✓			✓
Europe	Hungary	3.4 GHz				✓	

Appendix A: Spectrum configurations around the world

Region	Countries	Frequency bands	Applicable technologies*				
			GSM	CDMA	UMTS	FD-LTE	TD-LTE
Oceania, Asia Pacific	Australia, Japan	3.5 GHz					✓
Europe	Spain	3.5 GHz					✓
Europe	United Kingdom	3.5 GHz			✓		

* As of publication time, there are no commercial 5G networks in operation.

alternating current (ac)

An electrical current that changes polarity (i.e., direction) 50 to 60 times per second. It offers significant efficiencies when transmitted across power lines, making it the standard current for household use. *See also: direct current (dc).*

Andrew integrated management and operating system (A.I.M.O.S.)

The network management software solution for all CommScope-distributed antenna systems. A.I.M.O.S. performs configuration fault and inventory via SNMP for alarm forwarding.

antenna

a transformer that converts RF energy between guided waves on a transmission line and free space waves propagating through the atmosphere.

Antenna Interface Standards Group (AISG)

An industry group composed of more than 40 top manufacturers and service providers from all over the world. AISG was founded in 2001 and publishes universally-accepted industry protocols for communications between base stations and tower-based equipment such as antennas and tower-mounted amplifiers.

attenuation

The loss of power experienced by an RF signal as it moves from one point to another, as measured in decibels (db). Transmission line attenuation is expressed in either decibels per 100 feet (dB/100 feet) or decibels per 100 meters (dB/100 meters) of cable length.

automatic transmission power control (ATPC)

A system that dynamically raises transmission power to overcome the effects of interference.

azimuth coordinate system

The polar coordinate system used in the field by RF engineers and surveyors to map the radiation pattern of antennas. *See also: radiation pattern, spherical coordinate system.*

backhaul

The process of delivering a transmission signal between a central routing point in the network and a base station or radio close to the antenna, most often via high-capacity fiber-optic cables or point-to-point microwave antenna links. *See also: microwave antenna.*

bandpass cavity

A “frequency filter” that allows only a certain “band” of channels to pass through the filter. Out-of-band frequencies are prevented from

passing. Most devices have multi-stage bandpass cavities that filter out different frequencies at each stage.

bandpass duplexer

A duplexer that uses multiple bandpass cavities to separate transmitter and receiver signals—allowing for simultaneous two-way communications. *See also: duplexer, duplex communications, bandpass cavity.*

base station antenna standards (BASTA)

In 2014, the Next Generation Mobile Networks (NGMA) Alliance published these standards for LTE networks, defining a unified approach in procurement, planning for long-term network growth and common measurements of network performance across the industry.

bypass (pass-through) configuration

A singleband tower-mounted antenna with an integrated diplexer that adds a secondary, non-amplified RF path to the system.

centralized radio access network (C-RAN)

A network architecture that moves baseband functions from individual sites to a centralized location (a hub), connected by high-speed fiber. C-RAN networks are cost efficient for sharing

a pool of baseband units. They can support macro networks, small cell networks or distributed antenna systems, among others. Virtualizing baseband functions in software running in data centers is called a “cloud radio access network,” also shortened to C-RAN. *See also: distributed antenna system (DAS), macro cell sites, metro cell site, small cell.*

citizens broadband radio services (CBRS)

The designation for the 3.55–3.70 GHz band in the United States, where it has traditionally been used by the U.S. military for operation of seaborne radar, among other uses. It is now available to wireless operators, with the addition of a spectrum-sharing and prioritizing access system due to its three tiers of access priority (the military, licensed users [PAL] and lightly licensed users [GAA]). *See also: dynamic spectrum sharing, spectrum access sharing (SAS).*

co-channel dual-polar (CCDP) operation

Using two orthogonal polarizations of a single frequency to double bandwidth or improve diversity-based reception.

co-siting solutions

The technology and practices that allow multiple operators or technologies to share a physical site architecture.

coaxial cable

A transmission line built to prevent interference while carrying multiple signals. Coaxial cable consists of an inner core conductor and an outer sleeve conductor, separated by a nonconductive dielectric layer. Coaxial cable is often used to connect antennas to base stations. *See also: dielectric layer, hybrid cable, transmission lines.*

coordinated multipoint (CoMP)

In C-RAN deployments, the software-managed practice of pooling signals from multiple antennas to create additional capacity where interference would otherwise occur. *See also: centralized radio access network (C-RAN).*

densification

A general term describing the practice of adding cellular capacity in a specific geographic area by subdividing existing cells into a larger number of smaller cells in order to increase the reuse of spectrum.

dielectric layer

A non-conductive region filled with solid material, foamed material or open-air channels with insulating spacers that separates the two conductors of an RF transmission line. This layer may be tube shaped as for coaxial cables, or sheet shaped as for a printed circuit board. *See also: coaxial cable, transmission lines.*

direct current (dc)

An electrical current that runs continuously in a single direction, making it well suited for use in motors and electronic components such as semiconductors. Batteries also produce dc current. *See also: alternating current (ac).*

distributed antenna system (DAS)

A network of low-power radios and antennas that distribute cellular signals from a base station throughout a building, venue or campus area. *See also: centralized radio access network (C-RAN).*

dummy load

A simulated power load applied to an electrical system for testing purposes. *See also: voltage standing wave ratio (VSWR).*

duplex communications

A communications scheme that allows for both transmit and receive communications via the same equipment. *See also: duplexer.*

duplexer

A device—situated between a duplexed antenna and its associated transmitter and receiver—that provides isolation between the two signals. *See also: duplex communications.*

dynamic spectrum sharing

The ability to “share” licensed or unlicensed spectrum via an automated access method that enforces access priority. *See also: citizens broadband radio service (CBRS), spectrum access sharing (SAS).*

electrical potential

The difference in electrical charge between two points in space, measured in volts. The greater the difference, the higher the potential—and, therefore, the greater the voltage. *See also: volt, voltage polarity.*

electrical tilt antenna

An antenna fitted with internal phase shifters that can adjust its pattern tilt relative to the ground. Changing tilt affects the gain, or performance, of the antenna within defined geographical areas. *See also: remote electrical tilt (RET).*

environmental factors

Circumstances of temperature, sunlight exposure, humidity and other specific characteristics of an installation. Environmental factors play a large role in determining what kind of antenna, transmission line, power and other components are ideal for use in a particular location.

failures in time (FITs)

The number of expected component failures per billion operating hours. *See also: reliability, mean time between failure.*

flat fading

Total signal loss caused by atmospheric refraction. It is the result of a signal being bent completely out of its line-of-sight (LOS) connection with its receiver. *See also: line of sight (LOS).*

frequency multiplexing

A configuration that connects multiple base station services (operating in separate bands) to multiple antennas via a single feeder cable and its associated couplers.

fronthaul

The physical link (primarily fiber optic) between the centralized baseband units (BBUs) located at the C-RAN hub and the remote radio heads (RRHs) that are located at the cell site. *See also: centralized radio access network (C-RAN), remote radio head.*

grounding

Measures taken to control and facilitate the path of an electrical discharge from its source to the ground—avoiding potential damage to sensitive equipment along the way. Grounding is a key element in protecting an installation from damage by lightning strike or other hazards. *See also: quarter-wave shorting stub.*

guard bands

Narrow gaps kept between adjacent bands to minimize interference. Used by the low-loss combiner (LLC) to distinguish between different signals riding on combined bands. *See also: isolation, low-loss combiner, transmitter noise.*

horizontal separation

The practice of placing a transmitter's antenna a certain distance from the same device's receiving antenna to achieve the necessary isolation. *See also: duplex communications, isolation, vertical separation.*

hybrid cable

A cable combining both fiber-optic connectivity and copper power cable. Hybrid cables remotely power tower-mounted radios and connect them to base stations located on the ground. *See also: coaxial cable, transmission lines.*

in phase

A state of operation referring to multiple antennas radiating together at precisely the same time and rate.

indoor small cell

Small cell designed for deployment indoors to offload macro network traffic for users inside an enterprise, stadium, airport or other discrete indoor space. *See also: small cell.*

integrated power systems

Space-saving combinations of related components that are built into a single device for easy installation.

isolation

The amount of separation achieved between the transmitter and receiver in a duplex communication system. In general, more isolation translates to less interference between the two functions—and correspondingly clearer communications. *See also: duplex communications, horizontal separation, vertical separation.*

licensed spectrum

Government-regulated segments of the EM spectrum that are licensed for use by various broadcast networks, including cellular network providers. Licensed spectrum comes with exclusive rights to certain frequencies in a certain area—making it a prized asset for cellular networks. Licensed frequencies may be bought at open

auction or exchanged with another licensee.

line of sight (LOS)

The unobstructed space between transmitter and receiver. Longer hops must even account for the curve of the Earth as an obstruction.

low-loss combiner (LLC)

A device that combines same-band RF signals on the same RF path, with very low losses—allowing simultaneous operation of multiple transmitters on a single antenna. It applies guard bands and bandpass cavities to provide the necessary isolation between signals. *See also: bandpass cavity, guard bands, isolation.*

macro cell site

The conventional installation for the operation of a wide-scale cellular communications network. These are typically standalone antenna masts featuring a number of antennas, radios, amplifiers, power supply and other components needed to move traffic across the network. *See also: metro cell site.*

mean time between failure (MTBF)

The time between two consecutive failures during a component's normal operation. MTBF is one measure of a repairable system or product's reliability during normal operation. *See also: reliability, failures in time (FITs).*

metro cell site

A small, concealable miniature cell site that otherwise operates much like a macro site, albeit at lower power. Metro cells or outdoor small cells in particular are distinguished for their slim profile and easily-concealed form factor—helping them overcome challenges in local zoning and other appearance limitations. Deployed in great numbers, metro cells also enable the high-capacity networks that form the foundation of 5G services. *See also: macro cell site, small cell.*

microwave antenna

Antenna operating in the microwave frequency bands (typically 3 GHz and above) characterized by a highly directional main beam capable of carrying high-density traffic via line-of-sight (LOS) point-to-point links. In cellular networks, microwave antennas are commonly used for network backhaul. *See also: backhaul.*

multiband combining (MBC)

A configuration that combines multiple frequency bands into a common RF path, such as combining multiple operators or technologies operating on different bands. *See also: same-band combining.*

multiple input, multiple output (MIMO) antennas

An antenna architecture that splits data transmission into multiple streams and sends them at the same time on the same frequency using multiple de-correlated RF ports. MIMO rank is described by the number of paths entering and exiting the air interface. The expression 2x2 DL MIMO means there are two antennas at the transmitter and receiver in the DL.

nonlinearity

A location within an electrical circuit where voltage does not remain consistently proportional to power—generally caused by imperfect connections between components and cables or damage to a cable's structure. *See also: passive intermodulation (PIM).*

ohm

The unit of measurement of a material's electrical resistance. When applied to discussions of RF transmission lines, ohms refer to the inherent, or characteristic, loss of strength a signal encounters as it passes along a length of cable.

pass-through (bypass) configuration

A single-band tower-mounted antenna with an integrated diplexer that adds a secondary, non-amplified RF path to the system.

passive intermodulation (PIM)

A potential side effect of having more than one high-powered signal operating on a passive device such as a cable or antenna. PIM occurs at nonlinear points in a system such as junctions, connections or interfaces between dissimilar metal conductors—creating interfering frequencies that can decrease efficiency. The higher the signal amplitude, or power, the greater the effect. *See also: nonlinearity.*

quarter-wave shorting stub

A device inserted into the connection between transmission line and antenna that does not affect normal frequencies but will immediately short—and safely dissipate energy—when lightning frequencies attempt to cross. *See also: grounding.*

radiation pattern

The three-dimensional shape of an antenna's strongest signal transmission.

radome

A wind- and water-proofed fabric or plastic cover that protects an antenna from the elements.

receiver desensitization

Interference caused by unwanted frequencies entering a receiver's upper stage passbands. These errant signals create electrical variances that impede the receiver's operation. *See also: bandpass cavity.*

reliability

The probability of a device working correctly over a defined length of time, operating under specified conditions. *See also: failures in time (FITs), mean time between failure (MTBF).*

remote electrical tilt (RET)

The capacity to remotely adjust the aim of an antenna's beam to optimize its efficiency. RET uses actuators built into the antenna to adjust the beam up or down relative to the horizon. *See also: electrical tilt antenna.*

remote radio head (RRH)

A base station architecture that separates a cell site base station's RF and baseband functions for improved efficiency. RRH advantages include no active cooling requirement, lower overall power loss, less weight on the tower, and compact size.

resonant frequency

The natural tendency of a system to oscillate with larger amplitude at particular frequencies. At these frequencies, even small, periodic

driving forces can produce large amplitude oscillations.

same-band combining (SBC)

A configuration that combines multiple services, carried over the same bands, into a common RF path—such as combining multiple operators or technologies operating on the same bands. *See also: multiband combining.*

service company

In the wireless industry, cell site development partners that are responsible for actual construction on the site, including antenna towers, concrete footers and pads, security fencing, and equipment shelters are collectively known as service companies.

Shannon's Law

Created by Claude Shannon and Ralph Hartley, this law establishes a theoretical limit to how much data can be reliably pushed through a given amount of bandwidth.

signal to interference and noise ratio (SINR)

Measure of the quality of the RF channel. Higher SINR levels allow use of more efficient modulation schemes such as 256QAM and higher order MIMO.

signal polarization

The orientation of a signal's electric field relative to the ground. It may be horizontal or vertical.

small cell

A small cell site, usually with low-height antenna and small transmit powers, deployed to cover a small space or building—providing cellular coverage where macro sites may not be possible or practical. *See also: centralized radio access network (C-RAN), indoor small cell, metro cell.*

spectrum

The electromagnetic (EM) radiation covering particular frequencies. As it relates to wireless systems or devices, spectrum is the range of radio frequencies used by devices to communicate. *See also: unlicensed spectrum.*

spectrum access sharing (SAS)

A utility required to use the unlicensed 3.5 GHz citizens broadband radio service spectrum. SAS essentially "checks the line" before attempting to use it for network traffic, ensuring priority traffic maintains maximum accessibility. *See also: citizens broadband radio service (CBRS), dynamic spectrum sharing, unlicensed spectrum.*

spherical coordinate system

A geometric polar coordinate system used to mathematically map the radiation pattern of antennas. *See also: azimuth coordinate system, radiation pattern.*

split-mount radio system

A two-stage connection that lets microwave radios located in an indoor unit (IDU) receive and transmit through an antenna fitted with an outdoor unit (ODU).

transmission lines

In RF applications, the physical medium that conducts RF power from one point to another, usually between a base station and an antenna.

transmitter noise

Interference experienced by a receiver as a result of transmission power "leaking" into other nearby frequencies.

unlicensed spectrum

Ranges of the EM spectrum that do not require a license to use. Unlicensed spectrum can be accessed by anyone but introduces challenges of interference when competing signals occur nearby—and, in the case of CBRS in the United States, multi-tier access is managed by a spectrum access solution (SAS). *See also: citizens broadband radio service (CBRS),*

spectrum, spectrum access sharing (SAS), Wi-Fi.

vertical separation

The practice of placing a transmitter and receiver in separate locations on a single antenna, allowing the height difference to achieve the necessary isolation. *See also: duplex communications, horizontal separation, isolation.*

volt

A measurement of electric potential difference between two points in a path. Voltage is sometimes referred to as "pressure," because it shares many characteristics with pressure in a water pipe. *See also: voltage polarity.*

voltage polarity (+ and –)

The positive (+) and negative (–) designations of voltage refer to which polarity of a circuit is measured; in terms of actual power produced, the distinction is meaningless. *See also: volt.*

voltage standing wave ratio (VSWR)

A key measurement of cable performance and signal quality. It quantifies the amount of signal reflected backward along a cable to its source. Theoretically, perfect operation yields a VSWR value of 1.0, or "unity," meaning zero reflections.

wavelength division multiplexing (WDM)

The practice of sending multiple wavelengths of light down a single fiber-optic cable, making each fiber carry two or more parallel communications that are separated out at the other end.

Wi-Fi

Technology used for low-power, fixed wireless communications over relatively short ranges (from 10 to 50 meters) using unlicensed spectrum. Wi-Fi should not be confused with cellular networks, which use licensed spectrum and much higher power levels for mobile communications over larger areas, where users can hand off their communications from one cell to another. *See also: unlicensed spectrum.*

voltage standing wave ratio (VSWR)

A key measurement of cable performance and signal quality. It quantifies the amount of signal reflected backward along a cable to its source. Theoretically, perfect operation yields a VSWR value of 1.0, or "unity," meaning zero reflections.

CommScope pushes the boundaries of communications technology with game-changing ideas and ground-breaking discoveries that spark profound human achievement. We collaborate with our customers and partners to design, create and build the world's most advanced networks. It is our passion and commitment to identify the next opportunity and realize a better tomorrow. Discover more at commscope.com

www.commscope.com

Visit our website or contact your local CommScope representative for more information.

© 2018 CommScope, Inc. All rights reserved.

All trademarks identified by ® or ™ are registered trademarks or trademarks, respectively, of CommScope, Inc. This document is for planning purposes only and is not intended to modify or supplement any specifications or warranties relating to CommScope products or services.

EB-112900-EN (7/18)