



# GigaSHIELD™ X10D (F/UTP, F/FTP and S/FTP)

---

Solution guide: Europe, Middle East and Africa

# Contents

---

The GigaSHIELD X10D shielded Cat 6A portfolio.....	2
GigaSHIELD X10D F/UTP, F/FTP and S/FTP cables.....	3
GigaSHIELD X10D F/UTP and S/FTP patch cords.....	4
GigaSHIELD MGS600S information outlets.....	5
GigaSHIELD X10D patch panels.....	6
Faceplates.....	7
British standard style faceplates.....	7
Modular flush-mount faceplates.....	7
Modular surface-mount faceplates.....	8
Stainless steel faceplates.....	8
Surface-mount boxes.....	9
DIN rail.....	10
InstaPATCH® Cu connectivity system.....	11
imVision automated infrastructure management (AIM).....	13
VisiPORT™ solution.....	15
Supported and warranted by SYSTIMAX Assurance™.....	16

# The GigaSHIELD X10D shielded Cat 6A portfolio



For more than 40 years, SYSTIMAX® customers and partners have informed and inspired our endless innovation. We asked them what they needed in their Category 6A shielded solution.

They answered: **“More of what matters most.”**

- **More effective shielding** that consistently meets throughput and latency requirements
- **More streamlined processes** to accelerate deployment, change management and scaling
- **More design flexibility** to quickly modify and reconfigure channels—indoors and out
- **More automated network intelligence** to driver faster, more accurate decision making
- **More manageable jumpers** that are thinner and easier to handle and connect
- **More end-to-end thinking** that transforms individual components into a unified platform
- **More sustainability**, from eco-friendly/installer-friendly packaging to energy savings

The result of those conversations is the GigaSHIELD X10D portfolio, an end-to-end shielded Cat 6A platform that delivers optimal shielding, design flexibility, infrastructure intelligence, fast deployment, easy management and sustainability.

Available as an F/UTP, F/FTP and S/FTP design, the GigaSHIELD X10D platform is manufactured and tested to exceed the standards-based specifications for channel performance. It is the only shielded Cat 6A solution that is fully backed and supported by SYSTIMAX Assurance, among the industry’s most comprehensive customer support programs.

# GigaSHIELD X10D F/UTP, F/FTP and S/FTP cables

GigaSHIELD X10D F/UTP, F/FTP and S/FTP cables are at the heart of the GigaSHIELD X10D portfolio. Their four-pair construction with aluminum foil tape and isolator center member provide an extra margin of performance for high-bandwidth applications. As a result, the electrical performance of GigaSHIELD X10D shielded cables is guaranteed to meet or exceed the channel specifications of Amendment 1 to ISO/IEC 11 801:2002 Class E<sub>A</sub>, and ANSI/TIA-568-C.2 Category 6A up to 500 MHz. <sup>1</sup>

- Supports network line speeds of 10Gbps and beyond.
- Qualifies for SYSTIMAX 25-Year Extended Product Warranty and Applications Assurance<sup>1</sup>.
- All cables constructed with a single white jacket and packaged on reels
- All cables meet the requirements of IEC 60332-3

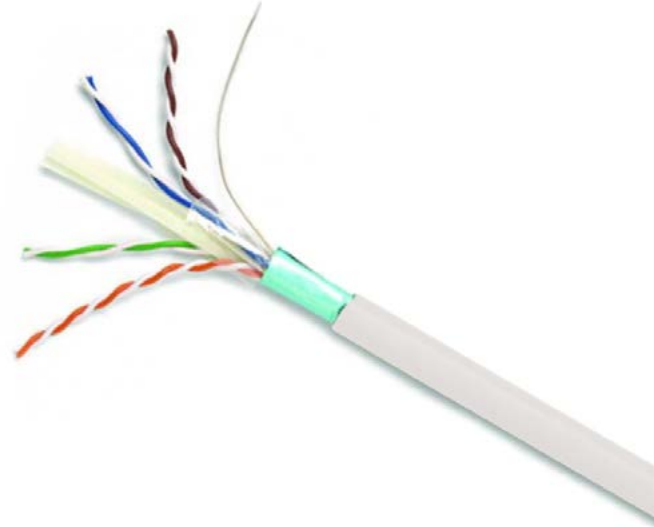

MID	Description	Jacket	EuroClass fiber performance	EuroClass smoke rating	Length
760081323	3291B WHT C6A 4/23 F/UTP R1000	LSZH	B2ca	s1a	305 m
760237886	3291B-B WHT C6A 4/23 F/UTP R1000	LSZH	B2ca	s1a	305 m
760189597	3296A WHT C6A 4/23 F/FTP R1640	LSZH	Dca	s2	500 m
760237952	3296A-B WHT C6A 4/23 F/FTP R1640	LSZH	B2ca	s1a	500 m
760159988	3297B WHT C7 4/23 S/FTP R1640	LSZH	B2ca	s2	500 m
760237946	3297B-B WHT C7 4/23 S/FTP R1640	LSZH	B2ca	s1a	500 m

<sup>1</sup>When used as part of a GigaSHIELD X10D F/UTP, F/FTP and S/FTP channel in registered SYSTIMAX installations

# GigaSHIELD X10D F/UTP and S/FTP patch cords

SYSTIMAX GigaSHIELD X10D F/UTP and S/FTP patch cords ensure modular flexible and best-in-class EMI / RFI rejection performance for reliable patching in noisy environments. Innovative design and consistent precision manufacturing combine to create dramatically lower performance variation and excellent end-to-end signal integrity. Patch cord performance has been characterized in thousands of channel configurations using modal decomposition modeling.

The GigaSHIELD X10D patch cord family also helps speed installation and reduce errors. A patented plug design features a distinctive metallized construction, low-profile rear housing, and anti-snap latch for easy, error-free installation and rapid field identification.



Material ID	Product #	Description	Length options
CA111H2	G10SP	Modular patch cord; black, orange, red, white, yellow slate, green	1-30 m
CA111K2	G10SP-L	Modular patch cord; black, dark gray, orange, red, white, yellow slate, green;	1-30 m
CAP11K2	G10SP-L ECO-packaging	Modular patch cord; black, dark gray, orange, red, white, yellow slate, green; eco-friendly, no SUP	1-30 m
CO1MMN2	MiNo6AS - LS-CM Dual Rated	MiNo6A shielded F/UTP patch cord.	1-40 m
COPMMN2	MiNo6AS - LS-CM Dual Rated ECO-packaging	MiNo6A shielded F/UTP patch cord ; eco-friendly, no SUP	1-40 m

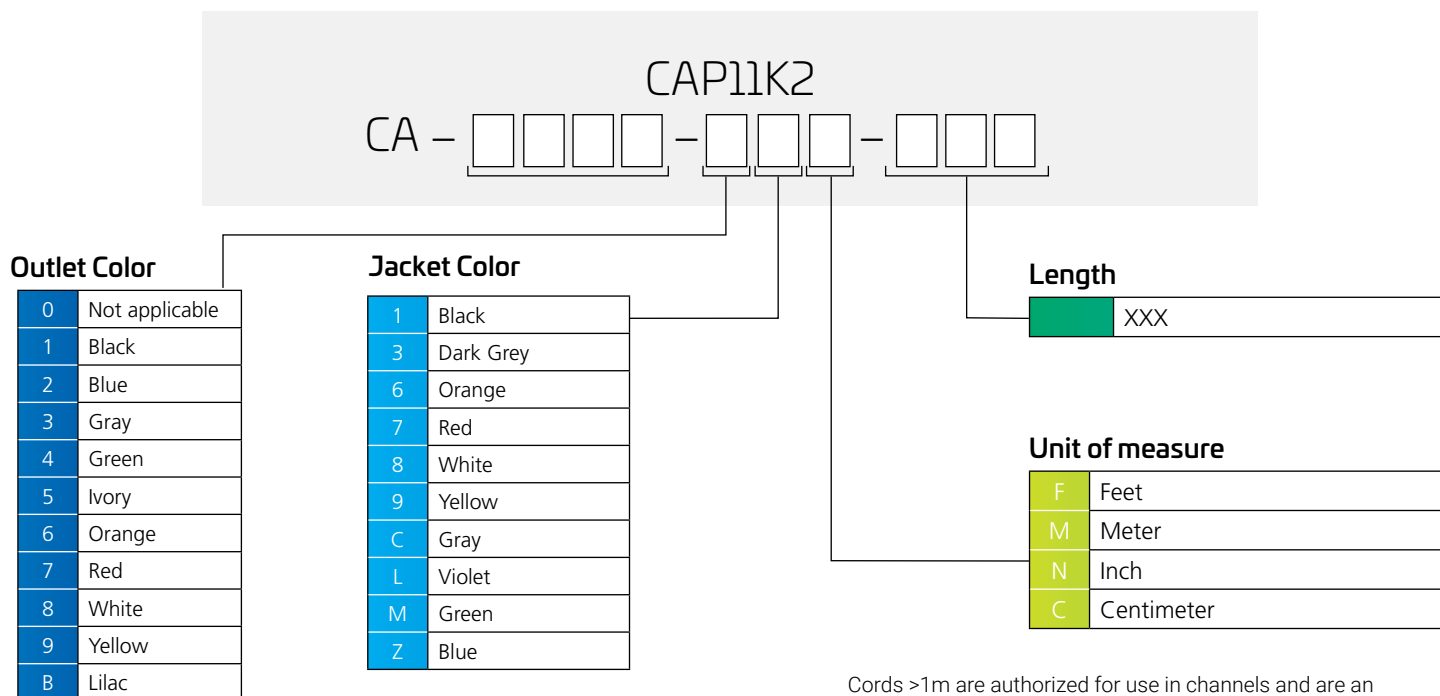

Cords >1m are authorized for use in channels and are an effective standalone method used to connect active devices

Cords < 1m are also valid elements for use in a channel or as an equipment interconnect but due to their limited length are not guaranteed to meet component compliance requirements that were developed to assess the quality of longer cords

# GigaSHIELD MGS600S information outlets

A key advantage of the GigaSHIELD X10D platform is a new and innovative MGS600S RJ45 outlet jack with a compact M-series footprint. The MGS600S builds on the legacy of the GigaSHIELD X10D solution modular jack design. When deployed with the SYSTIMAX JTT termination tool, these outlets install accurately, quickly and consistently. The new GigaSHIELD MGS600S jack comes in seven colors with 24 jacks in each eco-friendly package.



Material ID	Product #	Description
760258299	MGS600S-BK-24	GigaSHIELD X10D M-Series modular jack, RJ45, Cat 6A shielded, black (24 ea/pkg)
760258300	MGS600S-P. WH-24	GigaSHIELD X10D M-Series modular jack, RJ45, Cat6A shielded, prowhite (24 ea/pkg)
760258301	MGS600S-WH-24	GigaSHIELD X10D M-Series modular jack, RJ45, Cat6A shielded, white (24 ea/pkg)
760258302	MGS600S-GY-24	GigaSHIELD X10D M-Series modular jack, RJ45, Cat6A shielded, gray (24 ea/pkg)
760258303	MGS600S-IV-24	GigaSHIELD X10D M-Series modular jack, RJ45, Cat6A shielded, ivory (24 ea/pkg)
760258304	MGS600S-L.AL-24	GigaSHIELD X10D M-Series modular jack, RJ45, Cat6A shielded, light almond (24 ea/pkg)
760258305	MGS600S-BL-24	GigaSHIELD X10D M-Series modular jack, RJ45, Cat6A shielded, blue (24 ea/pkg)

\* Other colors on request

# GigaSHIELD X10D patch panels

GigaSHIELD X10D patch panels leverage the design of CommScope's popular SYSTIMAX 360™ shielded modular panels. The shielded modular panels offer easy cable routing and bundling through an innovative rear cable management design. They are available in 24-port/1U and 48-port/2U sizes and with straight and angled faces. GigaSHIELD X10D panels come with 24 or 48 of the new MGS600S outlets. (Empty GigaSHIELD X10D panels can be ordered to use with InstaPATCH only)

The panels also offer complete integration with the SYSTIMAX InstaPATCH® solution, which reduces installation time up to a fraction of the time needed for field-terminated solutions. GigaSHIELD X10D patch panels also integrate with the SYSTIMAX imVision® and VisiPORT™ solutions to deliver the port and network intelligence needed to manage the infrastructure for maximum operational efficiency and sustainability.



## GigaSHIELD X10D modular panels

Material ID	Product #	Description (each panel includes 24 or 48 jacks)
760237062	360-IPR-SMOD-6A-1U-24	SYSTIMAX 360™ GigaSHIELD X10D shielded modular panel, Cat 6A, 1U, 24 port, silver
760237063	360-IPR-SMOD-6A-2U-48	SYSTIMAX 360™ GigaSHIELD X10D shielded modular panel, Cat 6A, 2U, 48 port, silver
760237064	360-IPR-SMOD-A-6A-1U-24	SYSTIMAX 360™ GigaSHIELD X10D shielded angled modular panel, Cat 6A, 1U, 24 port, silver
760237065	360-IPR-SMOD-A-6A-2U-48	SYSTIMAX 360™ GigaSHIELD X10D shielded angled modular panel, Cat 6A, 2U, 48 port, silver

# GigaSHIELD X10D faceplates

GigaSHIELD X10D faceplates are made of high-impact, flame-retardant thermoplastic or stainless steel; thermoplastic faceplates come in six colors. Choose from one-, two-, four- and six-port configurations, labeled and non-labeled. Designs include British Standard (UK), surface mount (France/Germany/Benelux), and flush mount, including thermoplastic and stainless steel (all EMEA). All faceplates are compatible with the new MGS600S M-style outlets.

## British standard style faceplates (Market: UK)

MID	Product number	Ports	Shuttered	Labelled	Color
760253099	FPUS-BS-1P-B	1	No	Yes	Black
760253100	FPUS-BS-1P-W	1	No	Yes	White
760249255	FPUS-BS-2P-B	2	No	Yes	Black
760249256	FPUS-BS-2P-W	2	No	Yes	White
760254616	FPUS-BS-4P-B	4	No	Yes	Black
760254617	FPUS-BS-4P-W	4	No	Yes	White



## Modular flush-mount faceplates (Market: EMEA)

MID	Product number	Ports	Labelled	Color
760249144	FP-LBL-1P-266	1	Yes	Prowhite
760249145	FP-LBL-2P-266	2	Yes	Prowhite
760249146	FP-LBL-4P-266	4	Yes	Prowhite
760249147	FP-LBL-6P-266	6	Yes	Prowhite
760248924	FP-LBL-1P-003	1	Yes	Black
760248925	FP-LBL-2P-003	2	Yes	Black
760248926	FP-LBL-4P-003	4	Yes	Black
760248927	FP-LBL-6P-003	6	Yes	Black
760249136	FP-LBL-1P-270	1	Yes	Gray
760249137	FP-LBL-2P-270	2	Yes	Gray
760249138	FP-LBL-4P-270	4	Yes	Gray
760249139	FP-LBL-6P-270	6	Yes	Gray
760249168	FP-LBL-1P-246	1	Yes	Ivory
760249169	FP-LBL-2P-246	2	Yes	Ivory
760249170	FP-LBL-4P-246	4	Yes	Ivory
760249171	FP-LBL-6P-246	6	Yes	Ivory
760249128	FP-LBL-1P-262	1	Yes	Elec White
760249129	FP-LBL-2P-262	2	Yes	Elec White
760249130	FP-LBL-4P-262	4	Yes	Elec White
760249131	FP-LBL-6P-262	6	Yes	Elec White
760249152	FP-LBL-1P-448	1	Yes	Light Almond
760249153	FP-LBL-2P-448	2	Yes	Light Almond
760249154	FP-LBL-4P-448	4	Yes	Light Almond
760249155	FP-LBL-6P-448	6	Yes	Light Almond

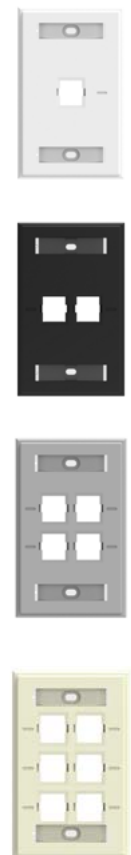



# GigaSHIELD X10D faceplates

## Modular surface-mount faceplates (Market: France/Germany/Benelux)

MID	Product number	Ports	Shuttered	Labelled	Color
760246283	M12FR-262 ECO	2	No	Yes	White
760085993	M12GER-262	2	Yes	Yes	White



## Stainless steel faceplates (Market: EMEA)

MID	Product number	Description	Color
760100867	M11SP	1 port stainless steel faceplate	Stainless Steel
760072074	M11SP-L	1 port 1 gang SS faceplate with label	Stainless Steel
108615188	M12SP	2 port stainless steel faceplate	Stainless Steel
760072181	M12SP-L	2 port 1 gang SS faceplate with label	Stainless Steel
108615196	M13SP 3	3 port stainless steel faceplate	Stainless Steel
760072199	M13SP-L	3 port 1 gang SS faceplate with label	Stainless Steel
108615204	M14SP 4	4 port stainless steel faceplate	Stainless Steel
760072207	M14SP-L	4 port 1 gang SS faceplate with label	Stainless Steel
108615212	M16SP 6	6 port stainless steel faceplate	Stainless Steel
760072215	M14SP-L	6 port 1 gang SS faceplate with label	Stainless Steel



# Surface-mount boxes

The GigaSHIELD X10D portfolio offers a diverse range of surface-mount boxes that fit our new MGS600S outlets. UL rated and specifically designed for copper connectivity and termination, these low-profile boxes are available in one-, two-, four- and 8-outlet configurations and a variety of colors. Plenum and non-plenum rated boxes enable use in most environments.

## Surface mount box

MID	Product number	Ports	Color
760246267	SMB-1P-003	1	Black
760248521	SMB-1P-262	1	Elec White
760248522	SMB-1P-270	1	Gray
760248523	SMB-1P-266	1	Prowhite
760248524	SMB-1P-448	1	Light Almond
760254710	SMB-1P-246	1	Ivory
760246268	SMB-2P-003	2	Black
760248525	SMB-2P-262	2	Elec White
760248526	SMB-2P-270	2	Gray
760248527	SMB-2P-266	2	Prowhite
760248528	SMB-2P-448	2	Light Almond
760254711	SMB-2P-246	2	Ivory
760252766	SMB-1P-262-PLENUM	1	Elec White
760252768	SMB-2P-262-PLENUM	2	Elec White
760252767	SMB-1P-003-PLENUM	1	Black
760252769	SMB-2P-003-PLENUM	2	Black
760254556	SMB-1P-448-PLENUM	1	Light Almond
760254557	SMB-2P-448-PLENUM	2	Light Almond
760044990	M204SMB-262	4	Elec White
760045005	M204SMB-003	4	Black
760057414	M208SMB-262	8	Elec White
760057422	M208SMB-003	8	Black
760254381	M204SMB-262-PLENUM	4	Elec White
760254382	M204SMB-003-PLENUM	4	Black
760254383	M208SMB-262-PLENUM	8	Elec White
760254384	M208SMB-003-PLENUM	8	Black



# DIN rail box and adapters

The GigaSHIELD X10D portfolio provides a DIN rail installation solution that includes DIN rail box and adapters. DIN rail box can support one six ports DDM module. DIN rail adapters are designed to assemble with SMB-1P/2P surface mount boxes.

## DIN rail box and module

MID	Description
760258278	DIN RAIL BOX, EMPTY, BLACK
760256558	CPP-UDDM-M-KIT-4PK

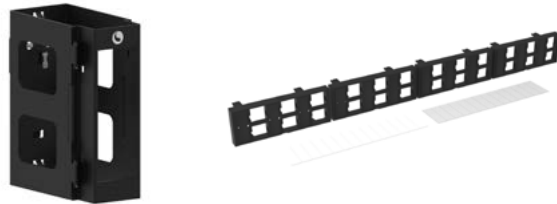

## DIN rail adapters

MID	Description
760258274	DIN RAIL ADAPTER, FTP, SMB-1P
760258275	DIN RAIL ADAPTER, UTP, SMB-1P
760258276	DIN RAIL ADAPTER, FTP, SMB-2P
760258277	DIN RAIL ADAPTER, UTP, SMB-2P

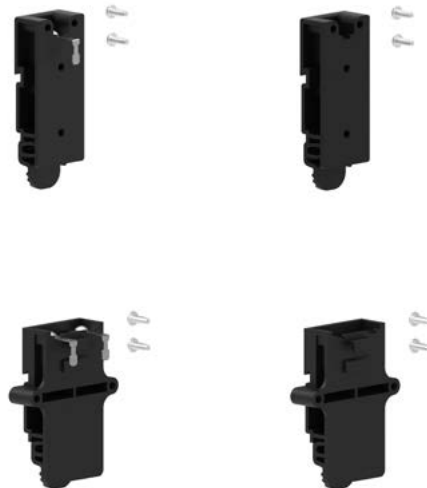

\* assemble with CommScope SMB-1P/2P surface mount box

# InstaPATCH® Cu connectivity system

The InstaPATCH Cu preterminated copper solution is a factory-connectorized, factory-tested, modular connectivity system featuring panel modules, outlets, modular plugs, and InstaPATCH OneLink or blunt endpoints.

Engineered for cleaner, more convenient installation, InstaPATCH Cu preterminated copper cable assemblies can be installed in a fraction of the time needed for field-terminated solutions. Designed for high-density environments such as data centers, InstaPATCH Cu solutions are ideal for rapid deployment and high performance. Their modular design supports improved cable management and scalable capacity. By avoiding the labor costs associated with traditional, on-site termination, troubleshooting and rework, these preterminated solutions are a smart investment for any data center or colocation facility. Additionally, these InstaPATCH Cu solutions are warranted by CommScope and backed by our industry-leading connectivity experience and start-to-finish design support.

## Copper assembly design

- Four-pair Category 6A F/UTP assemblies, six to 24 links
- Sleeving or hook-and-loop bundling options
- Design options include left, right or trident; series or paired; flat or angled
- Patch panel modules, outlets, modular plugs, InstaPATCH OneLink or blunt endpoints
- Sleeving or hook-n-loop bundling options available
- 23-inch breakout length from bundled exit
- Leg labels specify A or B side and the leg number
- 100% performance-tested to SYSTIMAX standards



MID	Performance	Environmental Space	Shielding	Connector 1	Connector 2	Link Count	Description
CFAAB	Cat 6A	LSZH	F/UTP	01S*	01S	06	IP6A-06LFTP-01S-01S
CFAAD	Cat 6A	LSZH	F/UTP	01S	01S	12	IP6A-12LFTP-01S-01S
CFAAG	Cat 6A	LSZH	F/UTP	01S	01S	24	IP6A-24LFTP-01S-01S
CFAXB	Cat 6A	LSZH	F/UTP	01S	BLUNT	06	IP6A-06LFTP-01S-BLUNT
CFAXD	Cat 6A	LSZH	F/UTP	01S	BLUNT	12	IP6A-12LFTP-01S-BLUNT
CFAXG	Cat 6A	LSZH	F/UTP	01S	BLUNT	24	IP6A-24LFTP-01S-BLUNT

\* 01S is the code name for MGS600S jacks

## Empty GigaSHIELD X10D modular panels

Material ID	Product #	Description
760251248	360-IPR-SMOD-1U-24	SYSTIMAX 360™ shielded angled modular panel, empty, 1U, 24 port, silver
760251247	360-IPR-SMOD-2U-48	SYSTIMAX 360™ shielded angled modular panel, empty, 2U, 48 port, silver
760251246	360-IPR-SMOD-A-1U-24	SYSTIMAX 360™ shielded modular panel, empty, 1U, 24 port, silver
760251245	360-IPR-SMOD-A-2U-48	SYSTIMAX 360™ shielded modular panel, empty, 2U, 48 port, silver

# InstaPATCH® Cu connectivity system

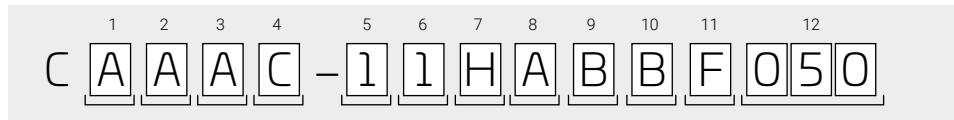

## 1. Cable type

A	Cat 6A X10D - U/UTP (Plenum)
B	Cat 6A X10D - U/UTP (Riser)
C	Cat 6A X10D - U/UTP (LSZH)
D	Cat 6A X10D - F/UTP (Plenum)
E	Cat 6A X10D - F/UTP (Riser)
F	Cat 6A X10D - F/UTP (LSZH)
G	Cat 6 XL - U/UTP (Plenum)
H	Cat 6 XL - U/UTP (Riser)
J	Cat 6 XL - U/UTP (LSZH)
R	Cat 6 - U/UTP Class B rated (LSZH)
S	Cat 6A - U/UTP Class B rated (LSZH)
Y	Cat 6A X10D SD - U/UTP (Riser)

## 2. Connector A

A	Outlet - Single row standard density
B	Outlet - Dual row standard density
C	Outlet - Dual row high density
G	RJ45 Plug - Single row standard density
H	RJ45 Plug - Dual row standard density
J	RJ45 - Dual row high density
N	1100 Module
R	360 1100 Evolve module
S	OneLink 2x6
T	OneLink 2x4
X	Unterminated

## 3. Connector B

A	Outlet - Single row standard density
B	Outlet - Dual row standard density
C	Outlet - Dual row high density
G	RJ45 Plug - Single row standard density
H	RJ45 Plug - Dual row standard density
J	RJ45 - Dual row high density
N	1100 Module
R	360 1100 Evolve module
S	OneLink 2x6
T	OneLink 2x4

## 4. Link

B	6
D	12
G	24

## 5. Orientation A

1	Trident series flat
2	Right paired flat
3	Right series flat
4	Left paired flat
5	Left series flat
6	Trident paired flat
A	Trident series angled
B	Right paired angled
C	Right series angled
D	Left paired angled
E	Left series angled
F	Trident paired angled

## 6. Orientation B

1	Trident series flat
2	Right paired flat
3	Right series flat
4	Left paired flat
5	Left series flat
6	Trident paired flat
A	Trident series angled
B	Right paired angled
C	Right series angled
D	Left paired angled
E	Left series angled
F	Trident paired angled
X	Not applicable

## 7. Bundling

H	Hook-n-loop
S	Sleeving

## 8. Labeling

A	Generic labeling
---	------------------

## 9. Outlet color

0	Not applicable
1	Black (BK)
2	Blue (BL)
8	White (WH)

## 10. Jacket color

8	White (WH)
C	Slate (SL)
2	Blue (BL)

## 11. UOM

F	Foot
M	Meter

## 12. Length

xxx	
-----	--

Cords > 1m are authorized for use in channels and are an effective standalone method used to connect active devices

Cords < 1m are also valid elements for use in a channel or as an equipment interconnect, but due to their limited length are not guaranteed to meet component compliance requirements that were developed to assess the quality of longer cords.

# imVision® automated infrastructure management (AIM)

CommScope's imVision automated infrastructure management (AIM) solution provides actionable insights and granular visibility into your network's complex, interdependent physical layer as well as the myriad devices connected to it. Consisting of intelligent panels, System Manager and controllers, imVision shows you exactly what you have, how different pieces interact, and where to find new optimization opportunities. Adding imVision network intelligence to your GigaSHIELD X10D network platform is quick, easy and seamless; it can be performed in the field without removing patch cords.

For network-driven businesses, imVision delivers three critical IT advantages:

## Optimized capacity

The imVision solution automatically tracks and documents utilization of panels, cables and switch ports, providing real-time data that helps you optimize the capacity and planning of your physical-layer assets. Its sophisticated tools reveal all active components to show you where you can get more from the infrastructure you already have.

## Optimized availability

The imVision solution reduces time-intensive manual processes, generating electronic work orders and enabling guided administration of connectivity changes, minimizing human error and network downtime. Visibility into end-to-end circuits means all changes are automatically fully documented. And, in the event of a network failure, a root cause analysis can be quickly established to help you get back online fast.

## Optimized efficiency

Real-time management of the physical layer ensures that stranded switch ports are identified and repurposed rather than remaining idle while continuing to consume power. It also optimizes server deployment and commissioning.

## imVision key features:

- Accurately documents end-to-end connectivity between networked devices
- Tracks all changes to physical-layer connections in real time
- Generates alerts for unauthorized or unplanned changes and any change to critical circuits
- Discovers and tracks network-connected devices
- Generates electronic work orders for guided deployment
- Delivers full reporting capabilities, including generation of custom reports
- Identifies unused IT assets and cabling available for reuse
- Simplifies and streamlines workflows through process automation
- Enables you to define custom fields associated to objects to track asset information

*Data is the lifeblood of your company. To keep it flowing efficiently and freely, you need to make business-critical decisions based on information—not assumptions. imVision from CommScope gives you the visibility and insight you need to direct your network's functionality with confidence.*

## imVision Controller X

Material ID	Product #	Description
760237876	imV-CNTRL-X	imVision Controller X
760237879	imV-CNTRL-RK-XT	Rack Extender Kit



## Intelligent Panels

Material ID	Product #	Description
<b>Panels with 24 jacks included in the kit</b>		
760259242	360-IP-SMOD-6A-1U-24	SYSTIMAX 360™ Intelligent Shielded Modular Panel, Cat 6A, 1U, 24 port, Silver
760259243	360-IP-SMOD-A-6A-1U-24	SYSTIMAX 360™ Intelligent Shielded Angled Modular Panel, Cat 6A, 1U, 24 port, Silver
<b>Empty panels for InstaPATCH</b>		
760259244	360-IP-SMOD-1U-24	SYSTIMAX 360™ Intelligent Shielded Modular Panel, Empty, 1U, 24 port, Silver
760259245	360-IP-SMOD-A-1U-24	SYSTIMAX 360™ Intelligent Shielded Angled Modular Panel, Empty, 1U, 24 port, Silver



# VisiPORT™

The VisiPORT solution is a fast-deploying, stand-alone solution that monitors the status and capacity of all copper and fiber ports in real time. Intelligent panels with integrated sensors automatically detect port activity, alerting users to issues such as insufficient capacity, unauthorized patching, device availability and more. It shows you the number, type and location of all patch panels, and automatically documents all port activity. So you can accelerate and improve infrastructure management while eliminating the need for, and risks from, manual tracking and auditing. With automated email notifications and remote-controlled port LEDs, the VisiPORT solution enables managers to quickly guide onsite techs to ports needing attention.

The VisiPORT solution gives enterprise and data center teams a single source of truth for all network ports and the real-time insight to make data-driven decisions.

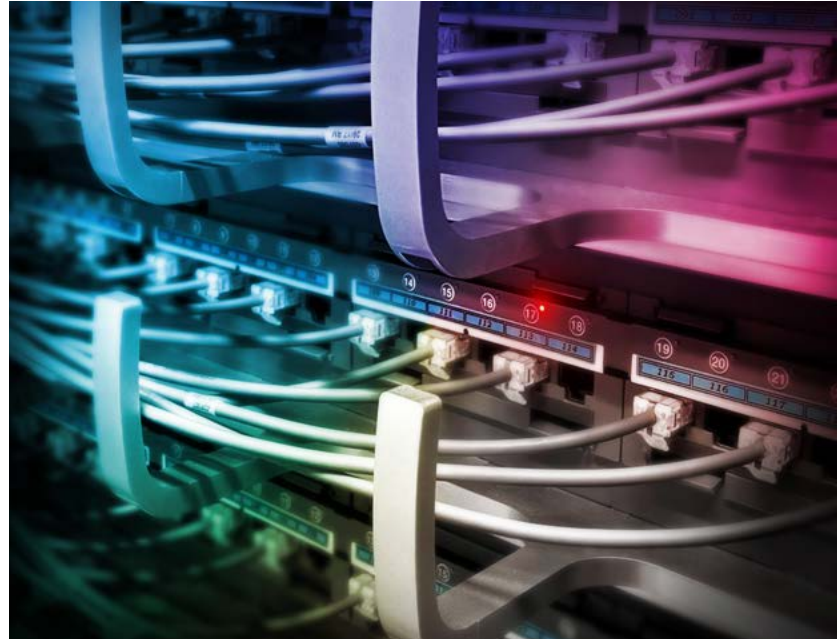

## Controller

Material ID	Product #	Description
760258085	VisiPORT Controller	VisiPORT Controller
760237879	imV-CNTRL-RK-XT	Rack Extender Kit



## Intelligent Panels

Material ID	Product #	Description
<b>Panels with 24 jacks included in the kit</b>		
760259242	360-IP-SMOD-6A-1U-24	SYSTIMAX 360™ Intelligent Shielded Modular Panel, Cat 6A, 1U, 24 port, Silver
760259243	360-IP-SMOD-A-6A-1U-24	SYSTIMAX 360™ Intelligent Shielded Angled Modular Panel, Cat 6A, 1U, 24 port, Silver
<b>Empty panels for InstaPATCH</b>		
760259244	360-IP-SMOD-1U-24	SYSTIMAX 360™ Intelligent Shielded Modular Panel, Empty, 1U, 24 port, Silver
760259245	360-IP-SMOD-A-1U-24	SYSTIMAX 360™ Intelligent Shielded Angled Modular Panel, Empty, 1U, 24 port, Silver





# Supported and warranted by the SYSTIMAX Assurance™ Program

The entire GigaSHIELD X10D shielded Cat 6A portfolio is backed by the global resources and technical expertise and product support of SYSTIMAX Assurance. The SYSTIMAX Assurance program is a bold new customer care initiative that delivers 360 degrees of support and performance, from inception to operation.

The SYSTIMAX Assurance program is the result of more than 40 years of ongoing dialogue with our customers. It is empowered by a global team of thoroughly trained SYSTIMAX technical experts and the CommScope Technical Assistance Center. In scope and resources, SYSTIMAX Assurance is unlike anything in the industry, yet the goal is so simple: Provide complete peace of mind.

The SYSTIMAX Assurance program is built on the strength and reputation of our legacy SYSTIMAX customer support program:

- 25-year extended product warranty
- 25-year applications assurance
- 24/7 online technical assistance
- Online product performance testing certificates (WebTrak®)

To this, we've added support services to keep you better informed, your people better trained, and your network better prepared for what's next:

- Digital warranty certificates
- Online product performance factory testing certificates
- Training for technical staff
- Local sales and technical support
- Free access to CommScope Infrastructure Academy
- Monthly newsletters and webinars
- Free 90-day imVision System Manager software trial
- Assistance with designs and BOMs
- Innovative self-service engineering tools
- Management and design software trials
- Onsite installation walkthroughs
- Onsite support
- RFP documentation assistance
- Rack elevations drawings
- FiberGuide® layout schematics and BOM
- BOM competitive cross reference
- Design tools and recommendations
- Solutions and product suggestions
- 24/7 online access to the Technical Assistance Center

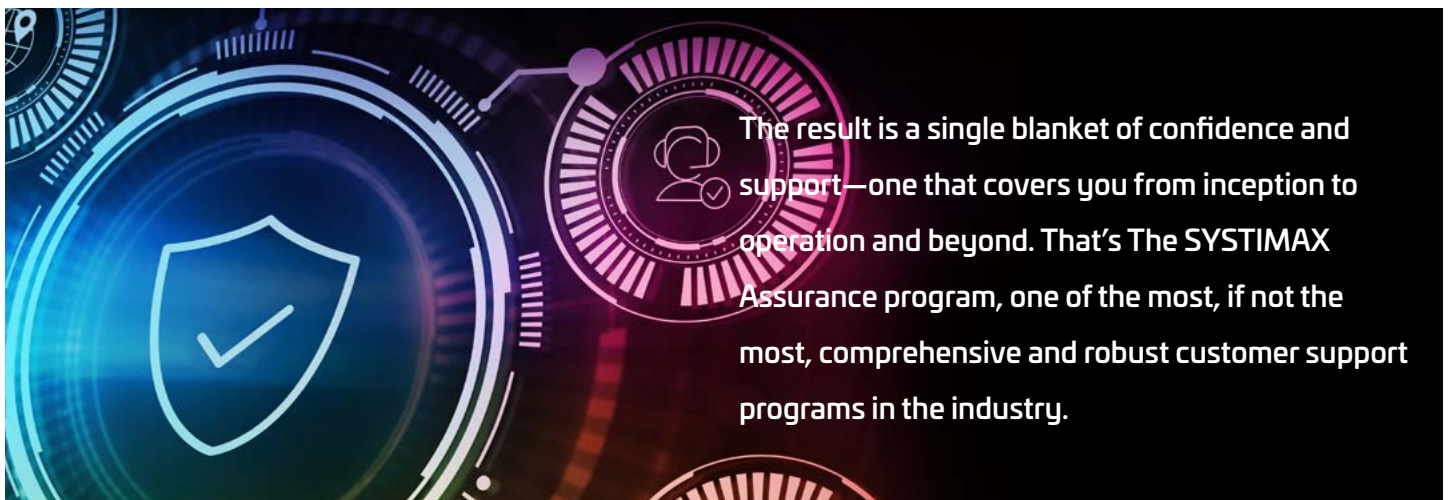

The result is a single blanket of confidence and support—one that covers you from inception to operation and beyond. That's The SYSTIMAX Assurance program, one of the most, if not the most, comprehensive and robust customer support programs in the industry.

CommScope pushes the boundaries of communications technology with revolutionary ideas and ground-breaking discoveries that spark profound human achievement.

We collaborate with our customers and partners to design, create and build the world's most advanced networks. It is our passion and commitment to identify the next opportunity and realize a better tomorrow. Discover more at [commscope.com](https://commscope.com)

**COMMSCOPE®**

---

[commscope.com](https://commscope.com)

Visit our website or contact your local CommScope representative for more information.

© 2024 CommScope, LLC. All rights reserved.

CommScope and the CommScope logo are registered trademarks of CommScope and/or its affiliates in the U.S. and other countries. For additional trademark information see <https://www.commscope.com/trademarks>. All product names, trademarks and registered trademarks are property of their respective owners.