

REVISION
B

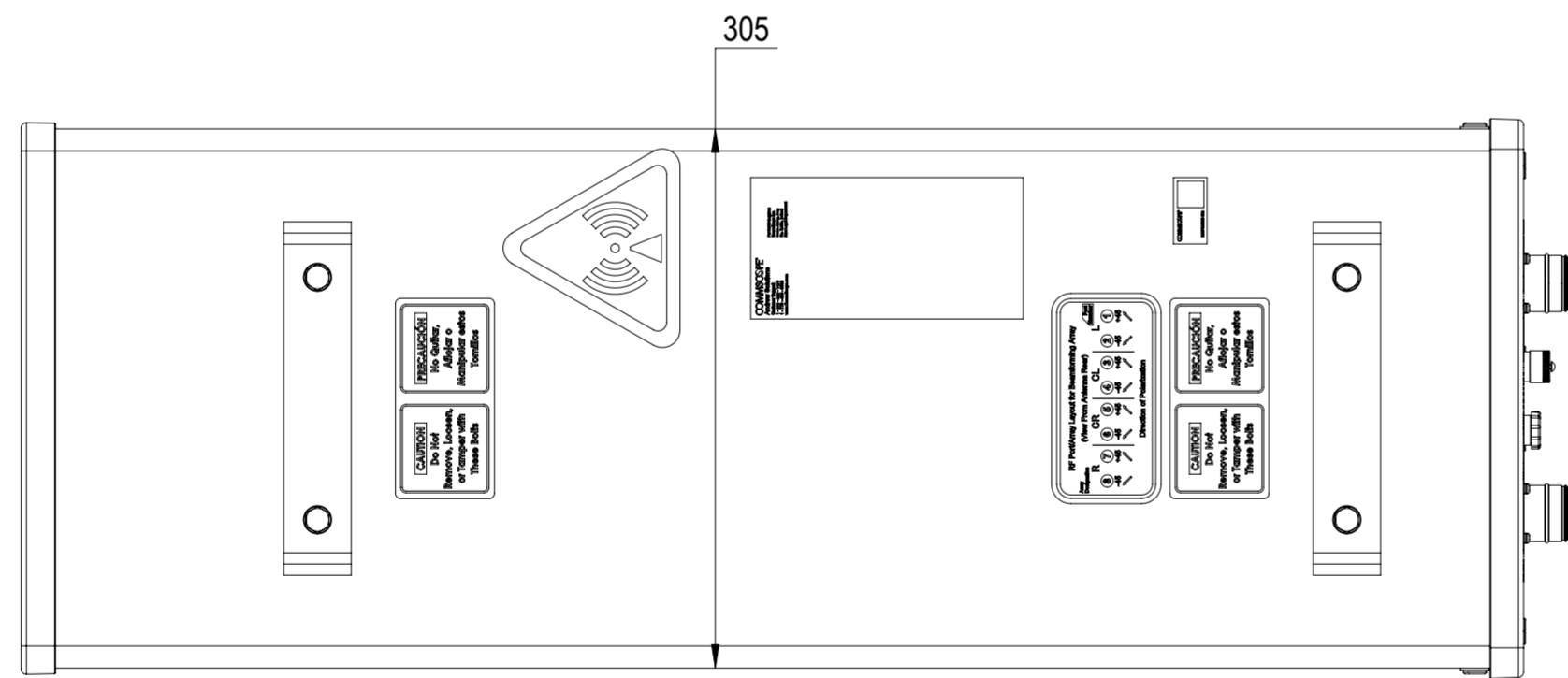
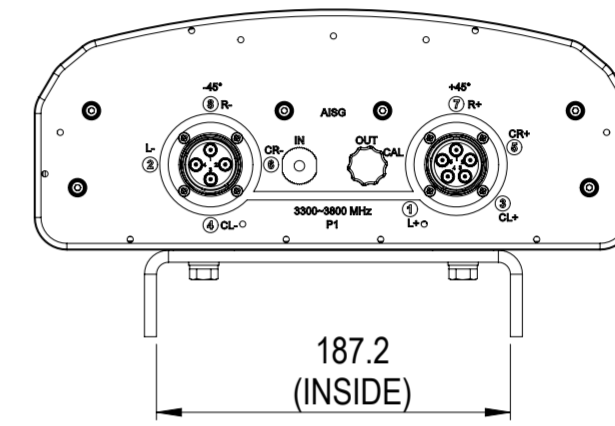
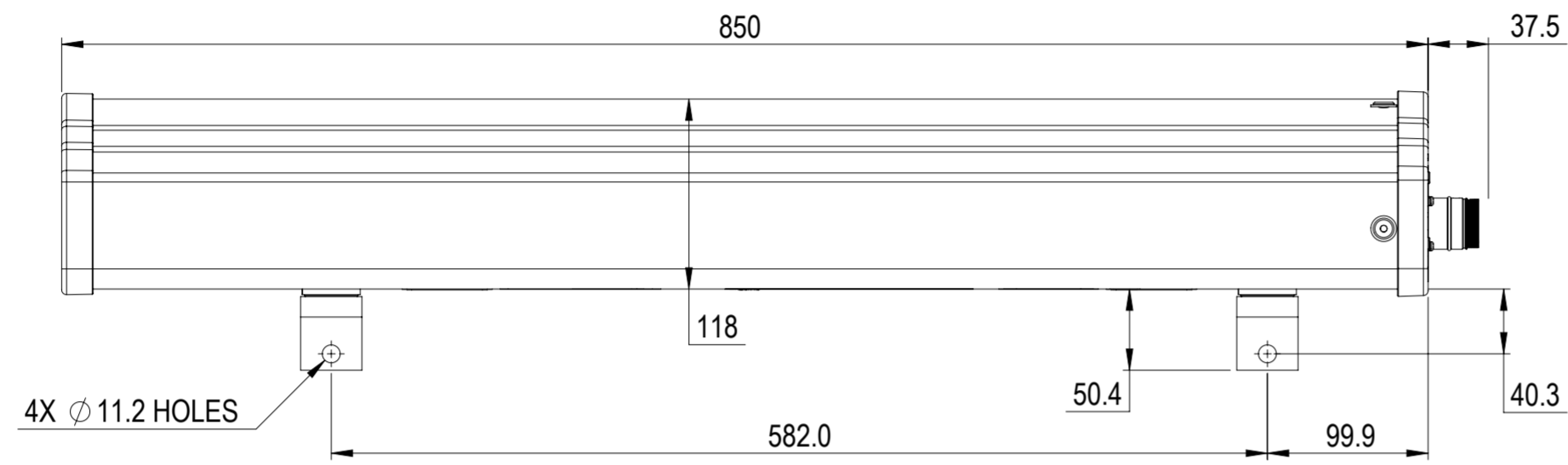

S4-90M-R1-V4