

HST-BBHKA0750NN000



HST, NOVUX™ Hardened Standard Terminal, 11-port, two Planar 1:4 Splitters + two P2P + one 4F port, Dielectric flat loose tube cable, 750 ft /228 m

- NOVUX™ Hardened Multi-fiber Terminals incorporate hardened connector technology that is designed to withstand the rugged outside plant environment
- Hardened connectors are factory-integrated and environmentally sealed for use in optical drop cable deployments
- Plug and play adapter ports ensure rapid cable installment in the outside plant access section of the network
- NOVUX™ HST terminals are available with 2 to 12 ports and can be utilized in Single Fiber Point-to-Point (P2P) solutions
- Available with flat dielectric, flat toneable/locatable dielectric, armored or 5mm round cable
- NOVUX™ smaller terminal size for aesthetics and allowing installation in constrained spaces
- NOVUX™ terminals are available in Black (RAL# 9005) or Gray (RAL# 7035)
- CommScope Product ID plate with QR code link to product documents and C-Track

Product Classification

| | |
|-------------------------------|---|
| Regional Availability | Asia EMEA Latin America North America |
| Product Type | Access terminal, with splitter/tap |
| Product Brand | NOVUX™ |
| Product Series | HST |
| Minimum Order Quantity | 1 |

General Specifications

| | |
|---------------------------------|---|
| Cable Type | Dielectric - Flat - Loose Tube |
| Cable, quantity | 1 |
| Distribution Type | 1 x 4 splitter (2) + P2P ports (2) + 4f ports (1) |
| Drop Port Type | Hardened full-size SC/APC |
| Drop Port, quantity | 8 |
| Enclosure Color | Black (RAL 9005) |
| Multi-use Port Type | Hardened full-size SC/APC |
| Multi-use Port, quantity | 2 |
| Mounting | Handhole Pedestal Pole Strand |
| Port Type | Hardened full-size SC/APC |
| Port, quantity | 11 |

HST-BBHKA0750NN000

| | |
|-----------------------------|----------------------------------|
| Splitter, quantity | 2 |
| Stub Type | Stub tail |
| Dimensions | |
| Height | 80 mm 3.15 in |
| Width | 157 mm 6.181 in |
| Length | 257 mm 10.118 in |
| Cable Length, stub | 750 ft (228 m) |
| Cable Outer Diameter | 4.3 x 8.0 mm (0.17 x 0.31 in) in |

Dimension Drawing

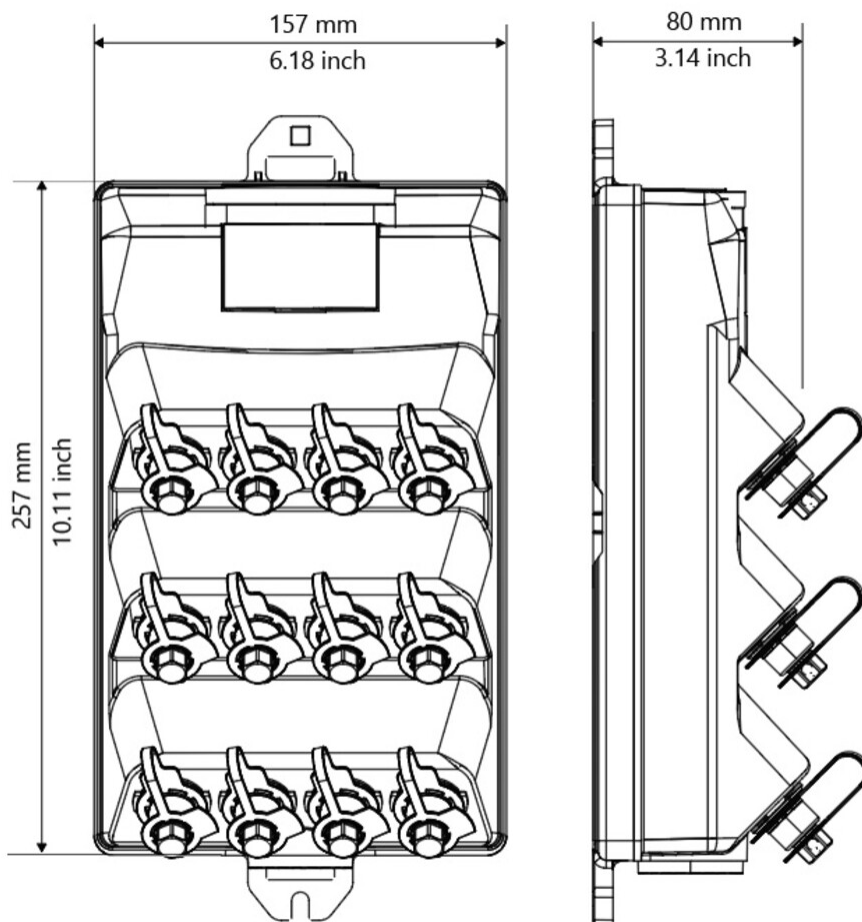

Port Configuration

HST-BBHKA0750NN000

| NOVUX HT | TECHNOLOGIES AVAILABLE | SMALL | MEDIUM | LARGE | |
|------------|--------------------------------|--------------------------------|--------------------------------|--------------------------------|---|
| HST Series | Single-fiber: P2P/no splitters | 2 ports | 6 ports | 12 ports | |
| | | 4 ports | 8 ports | | |
| | Single-fiber: P2P w/splitters | 2 ports, 1x1:2 | 8 ports, 2x1:4 | 12 ports, 3x1:4 | |
| | | 4 ports, 1x1:4 | 8 ports, 1x1:8 | | |
| | Hybrid for multi-use | | | 7 ports, 1x1:4 splitter, 3 P2P | 12 ports, 1x1:8 splitter, 4 P2P |
| | | 4 ports, 1x1:2 splitter, 2 P2P | 8 ports, 1x1:4 splitter, 4 P2P | | 11 ports, 2x1:4 splitter, 2 P2P, 1 HMFOC 4f |

Ordering Tree



Material Specifications

Enclosure Material Type

Hardened plastic

Optical Specifications

Fiber Type

G.657.A1/A2

Operating Wavelength Range

1260 – 1635 nm

Attenuation Single Ports, maximum

7.5 dB

Attenuation Cable Coefficient, maximum

0.30 dB/km @ 1550 nm | 0.40 dB/km @ 1310 nm

Attenuation Splitter, maximum

7.1 dB

HST-BBHKA0750NN000

| | |
|---|--------|
| Attenuation Terminal Connectors, maximum | 0.4 dB |
| Return Loss, Single Ports, minimum | 55 dB |

Environmental Specifications

| | |
|--------------------------------|---|
| Operating Temperature | -40 °C to +65 °C (-40 °F to +149 °F) |
| Relative Humidity | 5%–100%, condensing |
| Environmental Space | Above ground Below ground |
| Qualification Standards | IEC 60529, IP68 + 2 m waterhead IEC 61753-1, category G |
| UV Resistance | UV stabilized |

Packaging and Weights

| | |
|---------------------------|---|
| Packaging quantity | 1 |
| Packaging Type | Box Universal spool, cardboard: terminal is on top of the spool, stub deploys first |

Regulatory Compliance/Certifications

| Agency | Classification |
|---------------|--|
| CHINA-ROHS | Below maximum concentration value |
| ISO 9001:2015 | Designed, manufactured and/or distributed under this quality management system |
| REACH-SVHC | Compliant as per SVHC revision on www.commscope.com/ProductCompliance |
| ROHS | Compliant |
| UK-ROHS | Compliant |

