

7/8" EIA Positive Stop™ Connectors for HELIAX® Coaxial Cable

CommScope Infrastructure Academy offers installation training.

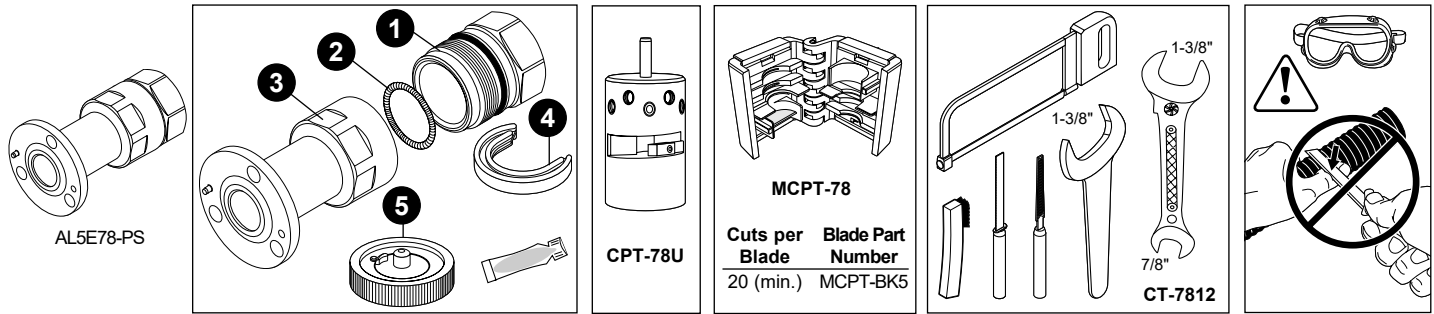

1a

Trim cable jacket
Recortar la envuelta del cable
Coupez la gaine du câble
Kabelmantel abziehen
Retire a capa do cabo
Rifilare la guaina del cavo.
修整電纜外皮

1" (25 mm)

6

1

1-9/16" (40 mm)

Remove jacket
Retire la envuelta
Retirez la gaine
Mantel abnehmen
Remova o revestimento
剥下护皮

2

RPC

Gently spin approx. 12 times
Gire suavemente unas 12 vueltas
Tournez environ 12 fois avec précaution
Vorsichtig um ca. 12 Umdrehungen drehen
Gire cuidadosamente cerca de 12 voltas
轻轻旋转 12 次左右

3

RPC

Remove jacket
Retire la envuelta
Retirez la gaine
Mantel abnehmen
Remova o revestimento
剥下护皮

4

1

2.0" (50 mm)

Remove jacket
Retire la envuelta
Retirez la gaine
Mantel abnehmen
Remova o revestimento
剥下护皮

2

RPC

1" (25 mm)

4

4

Deburr
Quitar las virutas
Ebavurez
Entgraten
Tirar as rebarbas
Sbavare
去毛刺

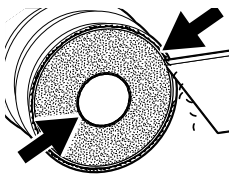

Inside edge, inner conductor
Borde interior, conductor interno
Bord interne, conducteur intérieur
Innenkante, Innenleiter
Borda interna, condutor interno
Bordo interno, conduttore interno
内缘, 内导体

Outside edge, outer conductor
Borde exterior, conductor externo
Bord externe, conducteur extérieur
Außenkante, Außenleiter
Borda externa, condutor externo
Bordo esterno, conduttore esterno
外缘, 外导体

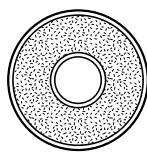

Be sure outer conductor is round and undistorted
Asegúrese de que el conductor externo es circular y no está deformado
Vérifiez si le conducteur extérieur a conservé sa forme ronde, sans distorsion
Außenleiter muss rund und nicht verformt sein. Verifique se o condutor externo está redondo e se não está deformado
Verificare che il conduttore esterno sia tondo e non deformato
外导体必须呈圆形, 且没有变形

5

Remove debris.
Retirar los restos.
Enlevez les débris.
Metallspäne entfernen.
Remova os detritos.
去除殘渣

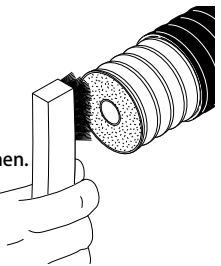

6

Add clamping nut.
Añadir la tuerca sujetadora.
Mettez en place l'écrou de serrage.
Klemmutter montieren.
加緊固螺母
Acrescente a porca de aperto.



7

Add spring ring.
Añadir el anillo elástico.
Mettez en place la bague ressort.
Federring montieren.
Acrescente o anel de mola.
加彈簧圈

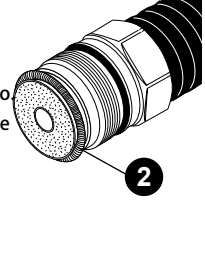

8

Compress foam.
Comprimir el material de espuma.
Comprimez la mousse
Verschäumung zusammendrücken.
Comprima a espuma.
壓緊泡沫塑:

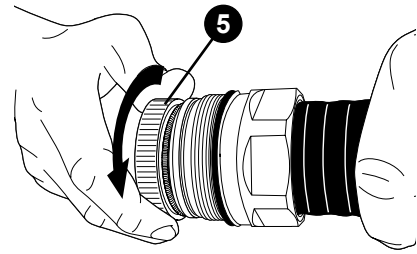

1/8" (3 mm) minimum
Mínimo 1/8" (3 mm)
1/8" (3 mm) minimum
Mind. 1/8" (3 mm)
Mínimo de 1/8" (3 mm)
Mínimo 1/8" (3 mm)

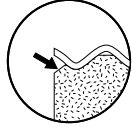

9

Attach connector to body.
Añadir el cuerpo del conector.
Fixez le corps du connecteur.
Steckergehäuse befestigen.
Coloque o corpo do conector.
清理毛刺和碎屑

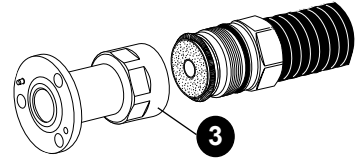

10

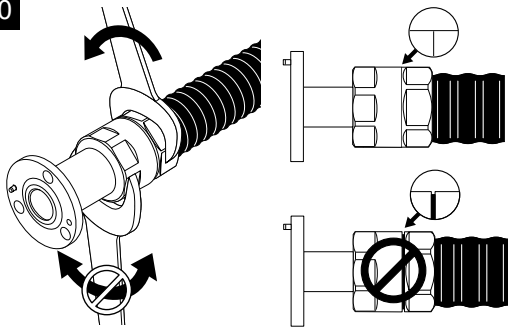

部件名称 (Part Name)	表一 有毒有害物质或元素名称及含量标识格式					
	有毒有害物质或元素					
连接器 (Connector)	铅 (Pb)	汞 (Hg)	镉 (Cd)	六价铬 (Cr6+)	多溴联苯 (PBB)	多溴二苯醚 (PBDE)
	X	O	O	O	O	O

O: 表示有毒有害物质在该部件所有的均质材料中的含量均在SJ/T 11363-2006规定的限量要求以下。
X: 表示该有毒有害物质至少在该部件的某一均质材料中的含量超出SJ/T 11363-2006规定的限量要求。

CommScope
3642 E US Highway 70, Claremont, NC 28610 USA
(828) 324-2200 (800) 982-1708
www.commscope.com

Customer Service 24 hours
North America: +1-800-255-1479 (toll free)
Any country: +1-779-435-6500
email: acicustomersupportcenter@commscope.com

Notice: CommScope disclaims any liability or responsibility for the results of improper or unsafe installation, inspection, maintenance, or removal practices.
Aviso: CommScope no acepta ninguna obligación ni responsabilidad como resultado de prácticas incorrectas o peligrosas de instalación, inspección, mantenimiento o retiro.
Avis : CommScope décline toute responsabilité pour les conséquences de procédures d'installation, d'inspection, d'entretien ou de retrait incorrectes ou dangereuses.
Hinweis: CommScope lehnt jede Haftung oder Verantwortung für Schäden ab, die aufgrund unsachgemäßer Installation, Überprüfung, Wartung oder Demontage auftreten.
Atenção: A CommScope abdica do direito de toda responsabilidade pelos resultados de práticas inadequadas e sem segurança de instalação, inspeção, manutenção ou remoção.
Avvertenza: CommScope declina eventuali responsabilità derivanti dall'esecuzione di procedure di installazione, ispezione, manutenzione e smontaggio improprie o poco sicure.
注意: CommScope 公司申明對於不恰當或不安全的安裝、檢驗、維修或拆卸操作所導致的後果不負任何義務和責任

© Sep, 2024 CommScope

