



DLX® Mini-MST, Fiber Optic Multiport Service Terminal, 4-port, round cable, 100 m/330 ft

- Hardened connectors are factory-terminated and environmentally sealed for use in optical drop cable deployments
- Plug and play adapter ports ensure rapid cable installment in the outside plant access section of the network
- Multiport Service Terminals incorporate hardened connector technology that is designed to withstand the rugged outside plant environment

Product Classification

Regional Availability	EMEA
Product Type	Access terminal, without splitter/tap
Product Brand	DLX®
Product Series	Mini-MST

General Specifications

Cable Type	Armored - Round - Loose Tube
Cable, quantity	1
Distribution Type	4 ports
Enclosure Color	Gray
Mounting	Handhole Wall
Port Type	Hardened mini-size DLX
Port, quantity	4
Splitter, quantity	0
Stub Type	Stub tail

Dimensions

Height	214.8 mm 8.457 in
Width	150 mm 5.906 in
Depth	58.7 mm 2.311 in
Cable Length, stub	330 ft (100 m)
Cable Outer Diameter	5.0 mm (0.20 in)

760235372 | MST-04FX00-U0100UM-IE-5MM

Dimension Drawing

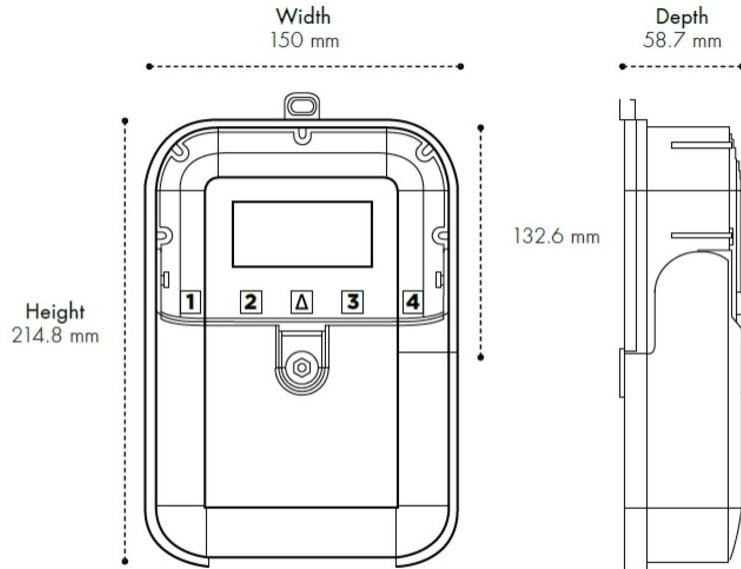

Ordering Tree

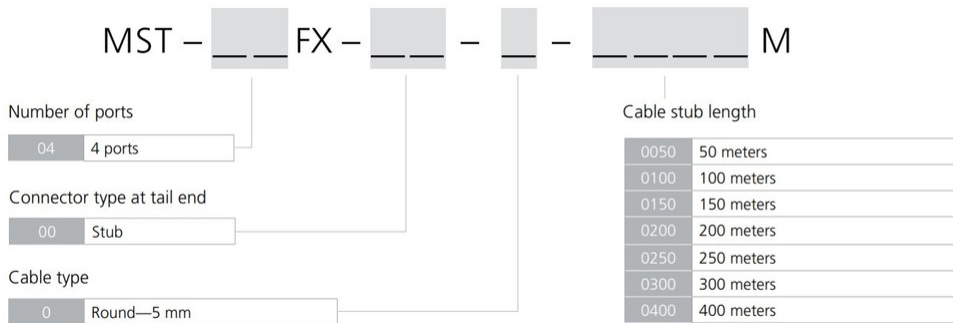

Material Specifications

Enclosure Material Type

Gasketed hardened plastic

Optical Specifications

Fiber Type

G.657.A1/A2

Operating Wavelength Range

1260 – 1635 nm

Attenuation Terminal Connectors, maximum

0.4 dB

Insertion Loss, Terminal Connector, typical

0.16 dB

760235372 | MST-04FX00-U0100UM-IE-5MM

Return Loss, Connector, minimum 65 dB

Environmental Specifications

Operating Temperature -40 °C to +70 °C (-40 °F to +158 °F)
Relative Humidity 5%–100%, condensing
Environmental Space Above ground | Below ground
Qualification Standards IEC 60529, IP65
UV Resistance UV stabilized

Packaging and Weights

Packaging quantity 1
Packaging Type Box | Carton
Weight, without cable 0.99 kg | 2.183 lb

Regulatory Compliance/Certifications

Agency	Classification
CHINA-ROHS	Below maximum concentration value
ISO 9001:2015	Designed, manufactured and/or distributed under this quality management system
REACH-SVHC	Compliant as per SVHC revision on www.commscope.com/ProductCompliance
ROHS	Compliant
UK-ROHS	Compliant

