

# A Side-By Side Comparison of Centralized vs. Distributed Access Architectures

**Mike Emmendorfer**

Senior director Systems Engineering

**Tom Cloonan, CTO**

Network Solutions

**John Ulm**

Engineering Fellow

**Zoran Maricevic**

Engineering Fellow

## Contents

<b>Introduction</b> .....	3
<b>Review of Hybrid Fiber Coax Optical Technology</b> .....	4
Overview of the “Current” FTTN Optical Technology .....	4
Pros .....	5
Cons .....	5
<b>Digital Fiber Coax (DFC) Introduction</b> .....	5
“Two Different” Fiber to the Node (FTTN) Architecture Classes for Cable and Two .....	6
Different Access Architecture Classes .....	7
Overview of Current and Future FTTN Optical Technology .....	8
Downstream DOCSIS and Edge QAM Functional Alignment to Headend and Node Platforms .....	10
Hybrid Fiber Coax (HFC) Class of FTTN .....	12
Digital Fiber Coax (DFC) Class of FTTN .....	13
<b>Example Platform and Network Architectures</b> .....	16
Broadband Digital Return and Forward Architecture .....	16
Broadband Digital Forward or Broadband Compressed Forward .....	16
Remote PMD Architecture .....	18
Remote Lower PHY (RL-PHY) Architecture .....	19
Remote PHY (R-PHY) Architecture .....	20
Remote Access Shelf Architecture .....	20
Remote CCAP Architecture .....	21
<b>Coaxial Segment Revenue Spectrum Capacity Consideration Details</b> .....	21
Comparison of HFC AM Optics and DFC Architectures .....	21
<b>Optical Segment Wavelength Capacity Consideration Details</b> .....	23
<b>Headend Space and Power Consideration Details</b> .....	24
Scaling Centralized Access Architectures .....	24
Headend Space for DAA .....	25
<b>Summary: Side-By-Side Comparison HFC vs DFC and CAA VS. DAA</b> .....	26
<b>Conclusions</b> .....	28

## Introduction

This paper will define and extensively compare two Classes of Access Architectures that will emerge this decade for Cable Networking. These two Classes of Access Architecture may be referred to as Centralized Access Architecture (CAA) and Distributed Access Architecture (DAA). The use of Centralize Access Architecture (CAA) retains the MAC and PHY layer functions of the CMTS, Edge QAM, or CCAP in the headend or hub location. The use of Hybrid Fiber Coax (HFC), which utilizes Amplitude Modulation (AM) optical technology or analog optics, enables only Centralized Access Architecture.

However, a transition to digital optics for fiber to the node (FTTN) may enable either a Centralized Access Architecture (CAA) or a Distributed Access Architecture (DAA). In a Distributed Access Architecture (DAA) the MAC and PHY layers of the CMTS, Edge QAM, or CCAP may be split between headend and node devices or the MAC and PHY layer functions of the CMTS, Edge QAM, or CCAP may be placed entirely in the node, cabinet, or MDU location. As our industry considers digital optics between the headend and fiber node we need to understand the pros and cons of CAA and DAA.

CommScope has been the foremost leader in defining the six different types of access architectures for cable networking; these include Remote CCAP, Remote Access Shelf, Remote PHY, Remote Lower PHY, Remote PMD (Physical Medium Dependent), and Broadband Digital. Our industry has always placed the least amount of intelligence in the outside plant, thus keeping the intelligence together and only at the headend and CPE locations (the bookends). The use of DAA fundamentally changes the style of access architecture cable has implemented since its inception.

Our industry is not aware of all these options; those that are aware from MSO to supplier are divided on which approach is best and why. We have compiled a complete evaluation criteria and side-by-side comparison of these six different types of Access Architecture, so that an MSO can make an informed decision.

Some of the most often asked questions by cable industry forward-looking planners reflect the key challenges the industry is facing for this decade and beyond. Some of these challenges and questions include:

- Can Digital Fiber Coax (DFC) architectures maximize the coaxial segment revenue spectrum capacity?
- Can Digital Fiber Coax architectures maximize the optical segment wavelength capacity?
- Can Digital Fiber Coax architectures maximize facility space, power, and cooling?
- Can Digital Fiber Coax architectures maximize long links and facility consolidation?
- Can Digital Fiber Coax architectures maximize the economics of OPEX and CAPEX?

This paper will seek to provide some visibility and answers to these questions and key challenges.

## Review of Hybrid Fiber Coax Optical Technology

The Amplitude Modulation (AM) optical layer will be examined in this section and illustrated in figure 1. The paper will only examine the forward optical technologies and performance attributes. The optical transport return path technologies include: Amplitude Modulation (AM) commonly referred to as analog optics, and Broadband Digital Return (BDR), which may be referred to as simply Digital Return.

This section will examine if the future capabilities of the cable access network will be limited by the fiber to the node (FTTN) optical technology. This section will examine the network capacity if we replaced the AM optics with digital optics, like those used for Broadband Digital Forward or Remote PHY or Remote CCAP, also called Remote Gadget is required.

This proved that AM optics used in today's HFC could support higher order modulations, such as those defined in DOCSIS 3.1. However, depending on spectrum, optical span, and optics type, use of the highest order modulations (yet to be defined) was not possible with current AM optics. There could be many other factors; the cable distribution network side, the size of the service group, the spectrum used, and it could be the optical technology.

### Overview of the "Current" FTTN Optical Technology

Amplitude Modulation (AM) optics, when used in the return path, had two types of lasers: Fabry-Perot (FP) or Distributed Feedback (DFB) lasers. Though HFC Amplitude Modulation used DFB in the forward for many years, the analog return path transport is considered as a viable option for Mid-split and High-split returns; supporting short to moderate return path distances of 0-50 km. If the wavelength is changed to 1550 nm, with an EDFA, even greater distances are possible.

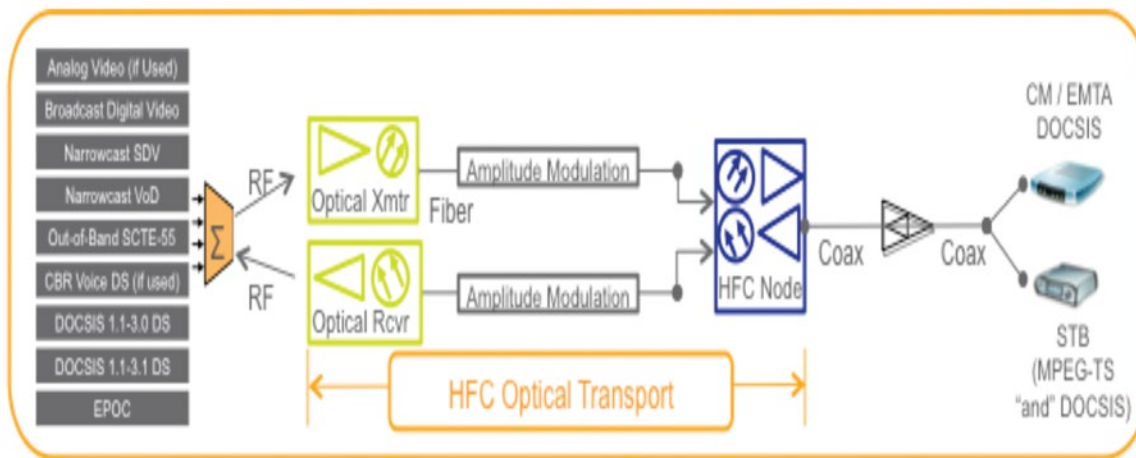

Figure 1: Overview of the Amplitude Modulation Optics

The analog optical return path transport presently supports up to 200 MHz loading; but typically only 5-42 MHz or 5-65 MHz is carried, depending on the distribution diplex filter split. The major benefit with analog optical return is its simplicity, lower cost, and flexibility, when compared with HFC style digital optical transmission. Distance is the chief challenge of analog optical transport and we will examine if support for very high order modulation, like that planned in DOCSIS 3.1, could be a factor.

## Pros

The chief advantage of analog return is its cost effectiveness and flexibility. If analog return optics are in use in the field today, there is a good chance that they will perform adequately at 85 MHz; and even 200 MHz loading may be possible, if required in the future. This would allow an operator to fully amortize the investment made in this technology over the decade.

## Important to Remember

AM optics may support very high order modulation (4K & 16K QAM) though there are some restrictions mainly due to:

- Dependence on the type of optics in the forward and return
- Distance, spectral loading, spectral placement in the low frequency band to achieve the highest modulation order, and service group size (upstream)
- AM optics short distance or O-band optics will yield best performance
- Manufacturer consultation is needed to confirm performance thresholds

## Cons

There are drawbacks to using analog optics: Analog DFBs have demanding setup procedures and RF levels at the optical receiver are dependent on optical modulation index and the received optical power level. This means that each link must be set up carefully to produce the desired RF output at the receiver (when the expected RF level is present at the input of the transmitter). Any change in the optical link budget will have a significant impact on the output RF level at the receiver, unless receivers with link gain control are used.

Also, as with any analog technology, the performance of the link is distance dependent. The longer the link, the lower the optical input to the receiver, which delivers a lower RF output and lower C/N performance.

## Digital Fiber Coax (DFC) Introduction

Moving from AM Optics to Digital Optics for FTTN will force us to place PHY or MAC/PHY Access Layer Functions in the Node. What stays in the headend and what moves to the node? The industry will need to define a new access network architecture supporting digital connections between headend and fiber node. This new access network architecture will redefine the CCAP architecture and other headend platforms (e.g. Digital Optical Platforms) as well as the node platforms.

In this section, the use of Digital Optics is required and this will place new functions in the Node and add or remove functions from the headend. It is of critical importance that we understand the functional layers and building blocks of MPEG-TS and DOCSIS MAC and PHY Functions as these functions may be split between the headend and node in the future. This section ends with several examples of Remote PHY layer or MAC and PHY functions in the node the node to support Digital Forward solutions.

As we examine the future to support higher data capacity in the optical and coax domain we may need to use digital optical technology for FTTN. We will examine this class of architecture that we are calling Digital Fiber Coax (DFC). The DFC Architecture is a network class, which differs from HFC in that MAC/PHY or just PHY processing is distributed in the outside plant (node) or MDU. The DFC architecture also uses "purely digital" optical transport technologies such as standardized Ethernet, G.709, PON, or other transport methods providing optical capacity to and from the node. The industry may determine to call this class of architecture something else, but the functions, technology choices, and architectures are different than HFC.

Digital Fiber Coax (DFC) is a “PHY or MAC/PHY Processing Architecture” in the node using Digital Optics to/from the node as seen in figure 2 and figure 3 is a side-by-side description of HFC and DFC. Thus Digital Fiber Coax (DFC) uses digital optical technology to and/or from the node as well as supports two different Access Architecture options for FTTN as seen in figure 4. Figure 5 is a side-by-side description of Centralized Access Architecture (CAA) and Distributed Access Architecture (DAA). DFC uses digital optics for FTTN (to/from) in either a Centralized Access Architecture (CAA) or a Distributed Access Architecture (DAA). For DFC in a Centralized Access Architecture (CAA), the CCAP MAC and PHY functions in headend (HE) or Primary Hub (PH) only.

For DFC in Distributed Access Architecture (DAA) the CCAP MAC and PHY or PHY functions are placed in a node. As with Centralized Access Architectures, there are several platform access architectures, this is even more the case with Distributed Access Architectures that will split the MAC and PHY layers of CCAP between the headend and the node. In the full Remote CCAP option for DFC, the entire CCAP MAC and PHY layers are placed in the node or MDU location. This section will provide terms and definitions to the different Fiber to the Node Classes cable may select, like HFC or DFC as well as the two different Access Architecture classes options that may emerge this decade and beyond as seen in figure 6.

### “Two Different” Fiber to the Node (FTTN) Architecture Classes for Cable and Two Different Access Architecture Classes

In this section, we describe the functions of several approaches for fiber to the node (FTTN). The following figures will aid in aligning the definitions with the list of functions; please refer to figures 2 through 6.

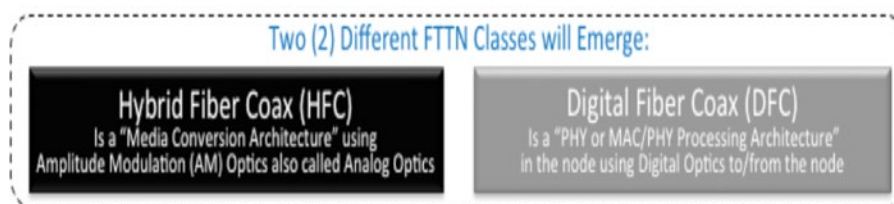

Figure 2: Two Different FTTN Classes for Cable will Emerge

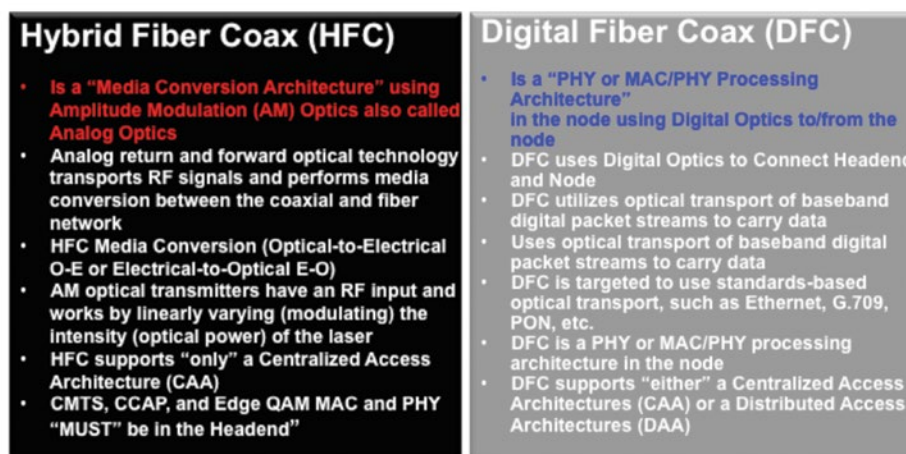

Figure 3: Descriptions of the Two Different FTTN Classes

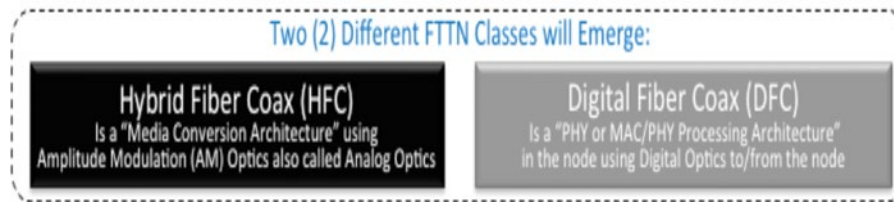

Figure 4: Two Different Access Architecture Classes for Cable will Emerge

**Two (2) "Different" Access Architecture Classes will be enabled by DFC:**

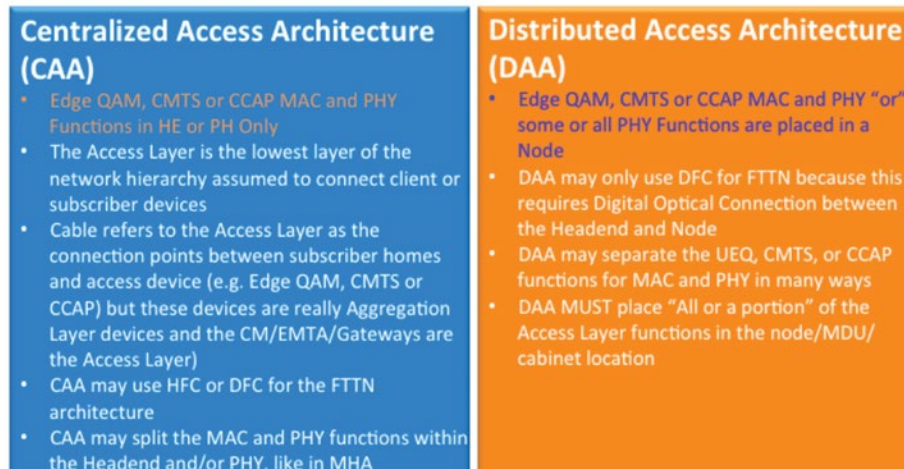

Figure 5: Descriptions of the Two Different Access Architecture Classes

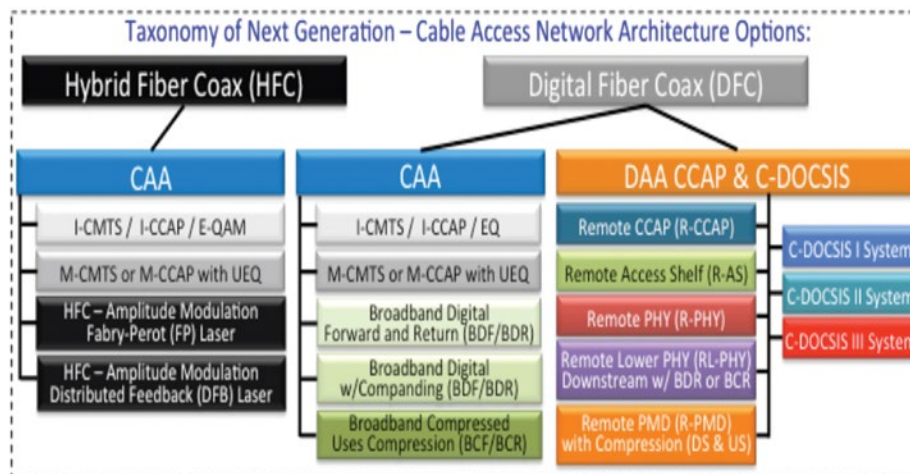

Figure 6: Taxonomy of Next Generation—Cable Access Network Architecture Options

## Overview of Current and Future FTTN Optical Technology

The optical layer and the relationship to the remote access layer architecture will be examined in this section.

Today, the two technologies used in optical transport for the return includes Amplitude Modulation (AM) and Broadband Digital Return (BDR); these are reviewed in the preceding section. The Broadband Digital term and current application is tied to the return path; **however, this could be used for the forward path as well.**

Broadband Digital Return places the lowest layer of the physical (PHY) layer called the PMD (Physical Medium Dependent) function in the Node. The PMD layer of the PHY is where the ADC/DAC (Analog-to-Digital or Digital-to-Analog) functions take place.

The FTTN technology and architecture for HFC has always retained one core function – transparency of the underlying MAC/PHY technologies that travels through it. The transparency of the RF MAC/PHY technologies was possible because of the optical FTTN technology used to include either Amplitude Modulation optical technology or Broadband Digital.

In the future, we need to consider the possibility of moving the IP/Ethernet transport past the HE/Hub locations to the node. We will examine what we are referring to as a new class of cable FTTN architecture called Digital Fiber Coax (DFC). The use of DFC may augment the existing HFC media conversion class of architecture that has been deployed for about two decades. We are suggesting that there are really two different Fiber to the Node (FTTN) architecture classes for Cable Networks. These will utilize FTTN and coaxial cable as the last mile media, but this is where the similarities will stop.

To simply summarize, the two different cable FTTN network architecture classes are:

- HFC, a “Media Conversion Architecture”
- DFC, a “PHY or MAC/PHY Processing Architecture”

These new FTTN technologies and architectures have or will emerge, and if implemented may remove this transparency.

Should the cable industry change the definition of HFC to mean multiple functions, “or” define a new term(s) for this fundamentally different Class of FTTN Network Architecture that uses Digital Optics to/from the node as illustrated in figure 9 which keeps the MAC and PHY functions of the CMTS, Edge QAM and CCAP in the headend and enable Digital transport through a separate optical transport shelf using a Digital Fiber Coax architecture called Broadband Digital. If it is decided to break up the CCAP and place digital optics directly on the CCAP, a Remote PHY CCAP Class of DFC is possible as seen in figure 10 or a MAC and PHY CCAP Class of DFC functions in the node as seen in figure 11 is possible.

The figures in the sections represent the high-level functions and technology placement in the headend and node.

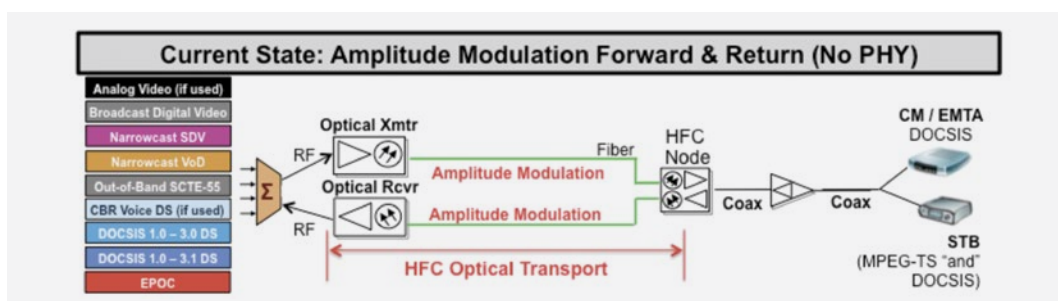

Figure 7: HFC Amplitude Modulation Forward and Return



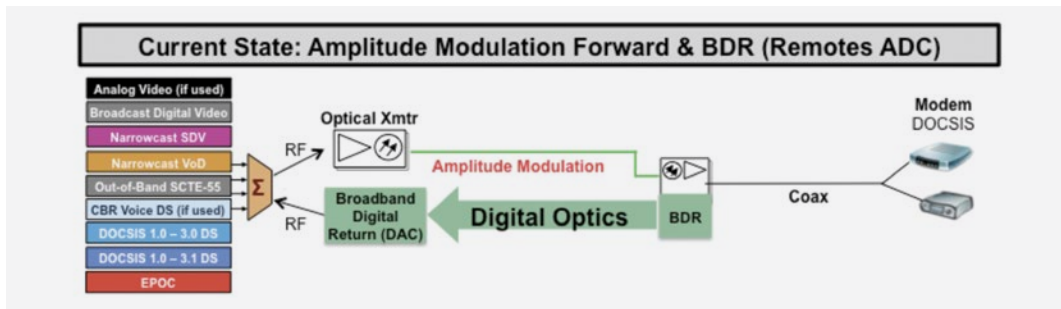

Figure 8: HFC Amplitude Modulation Forward and DFC Broadband Digital Return (BDR)

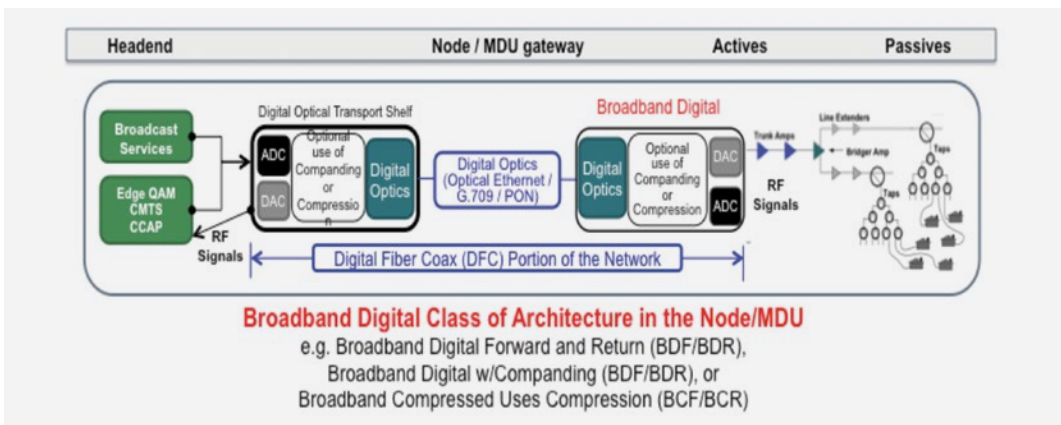

Figure 9: Digital Fiber Coax—Broadband Digital Class

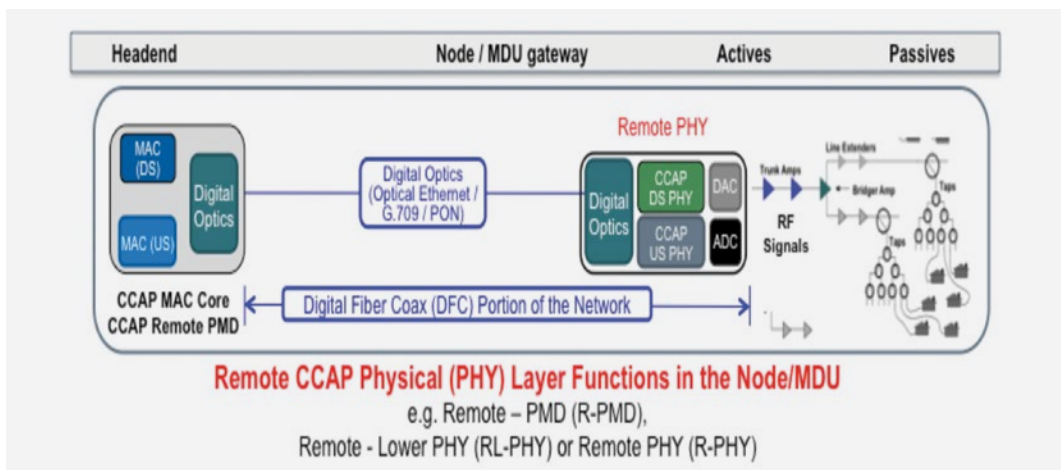

Figure 10: Digital Fiber Coax—Remote PHY CCAP Class

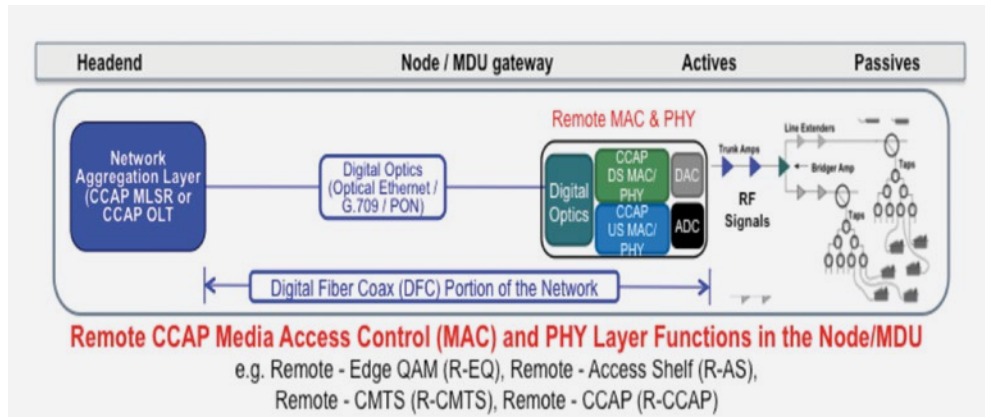

Figure 11: Digital Fiber Coax – Remote MAC and PHY Class

### Downstream DOCSIS and Edge QAM Functional Alignment to Headend and Node Platforms

This section and associated figures are meant to align cable technologies to the OSI reference model. The technologies examined include DOCSIS 3.0 and Edge QAM functions to the left which both use Recommendation ITU-T J.83 as the Physical Layer. The right side of the figure 12 is an attempt to define the “possible” framework for DOCSIS 3.1 currently in development. This figure is based on the DOCSIS specifications, ITU-T J.83-B, and DVB-C2. This is aimed to help show the functions of the Remote Access Layer Architecture that may remain in the headend and that which is placed in the node.

The figure below captures the downstream DOCSIS and Edge QAM functions. The figure is intended to show the relationship with headend functions defined today and functions that will change in the headend CCAP and the node to support Remote Access Layer Architectures. The red boxes represent node functions and all align with the functions defined on the left of the figure. Please note that figure 10 above places the Edge QAM MAC functions partially in the PHY layer and this is because all edge QAMs products contain the Edge QAM MAC and the J.83 PHY used for video and DOCSIS. Figure 11 below figure 10 removes the Edge QAM MAC functions from the PHY and places this alongside the DOCSIS MAC functions.

### Digital Video and DOCSIS MAC and PHY Functions

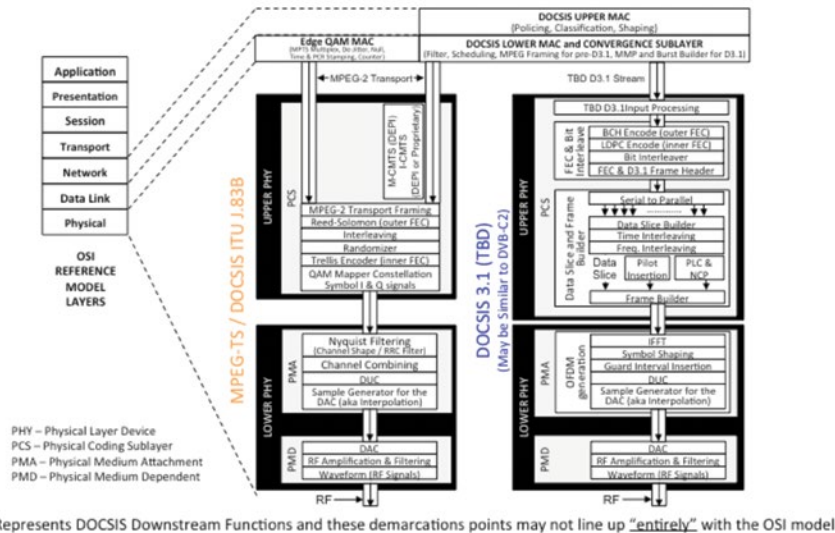

Figure 12: Detailed Digital Video and DOCSIS MAC and PHY Functions for the Downstream

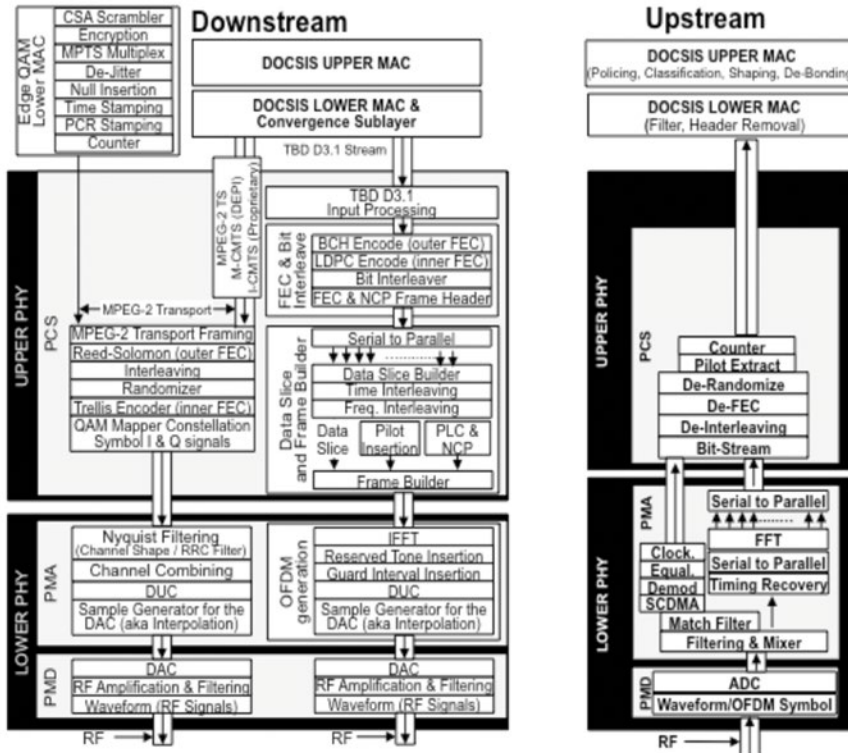

Figure 13: Functional Review of the RF MAC/PHY Layers Downstream and Upstream

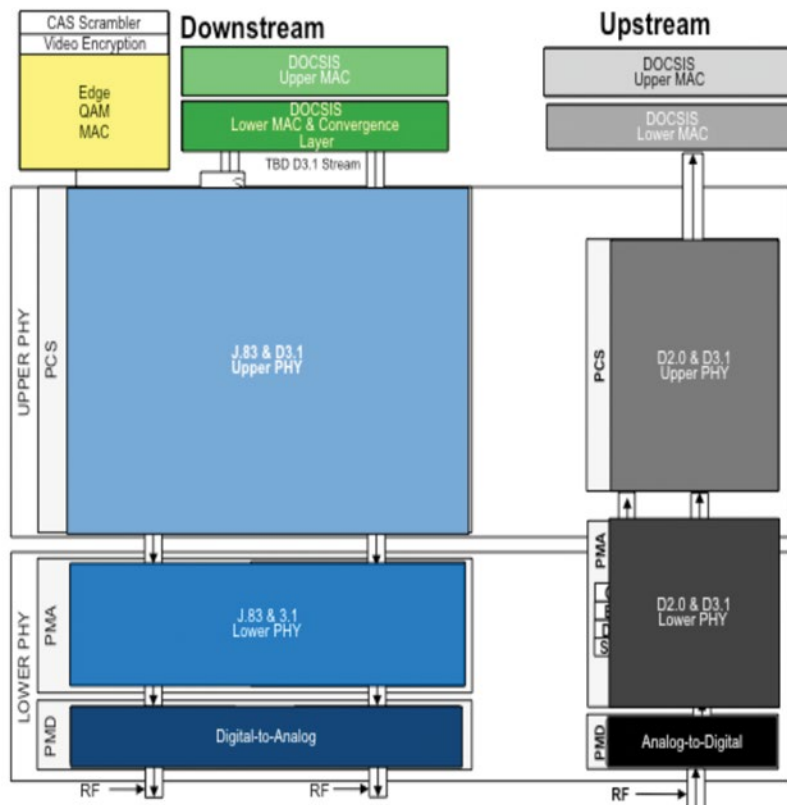

Figure 14: Simplified View of the RF MAC/PHY Layers Downstream and Upstream

These fundamental building blocks as illustrated above may serve as demarcation for functions that may be kept in headend platforms and those placed in Node or MDU locations. The next section takes these blocks and moves them to headend or node locations to illustrate the different architectures that may exist in the future to enable Digital Fiber Coax (DFC).

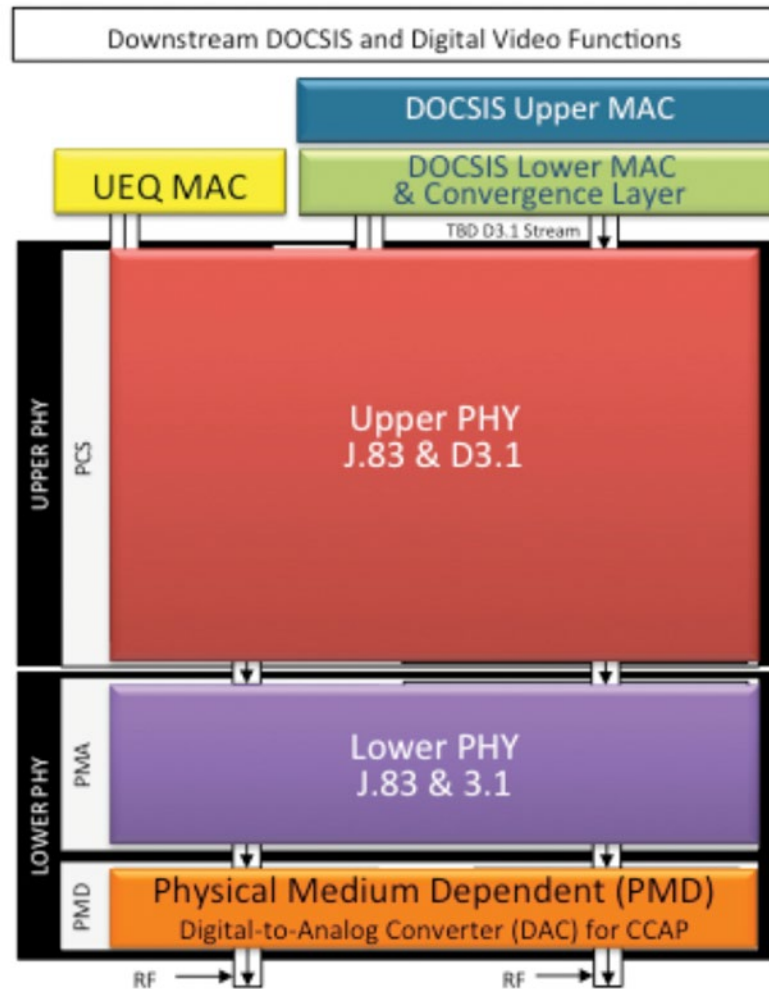

Figure 15: Summary Digital Video and DOCSIS MAC and PHY Functions for the Downstream

### Hybrid Fiber Coax (HFC) Class of FTTN

Optical Amplitude Modulation uses Media Conversion (Optical-to-Electrical or Electrical-to-Optical) allowing for transparency of the RF MAC/PHY technologies. This is what we have used for decades. Please refer to figure 16.

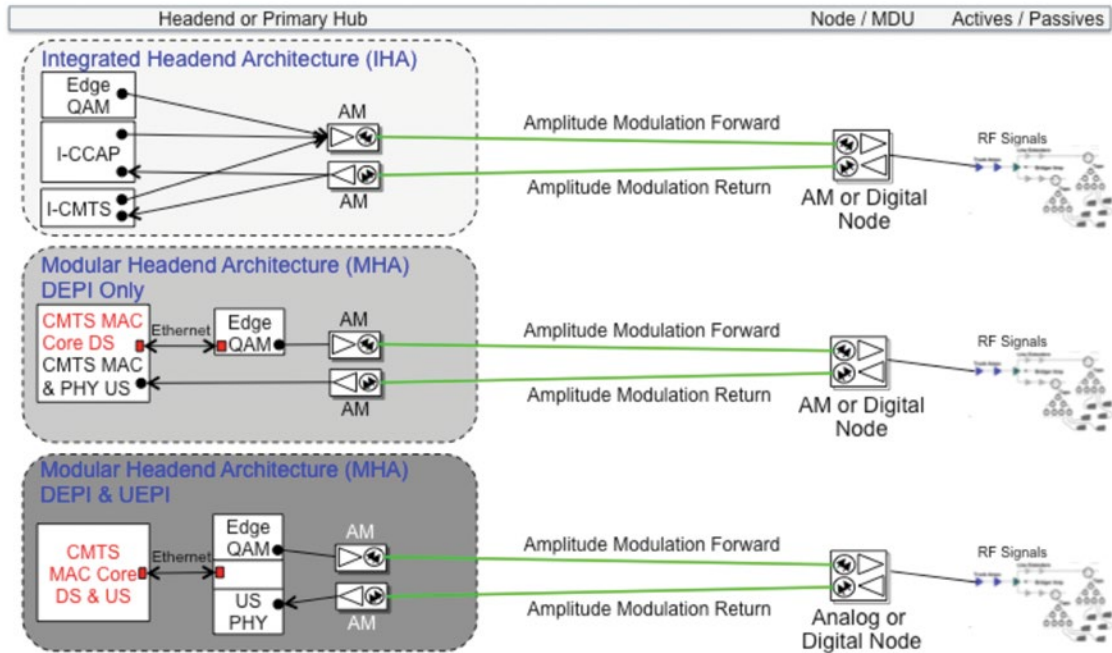

Figure 16: Summary Digital Video and DOCSIS MAC and PHY Functions for the Downstream

### Digital Fiber Coax (DFC) Class of FTTN

The Digital Fiber Coax (DFC) Class of Fiber to the Node (FTTN) can be separated into six different types of architectures. In the figure below, the type of CAA and DAA are associated with types of DFC architecture. Today's CAA can be carried over HFC optics as well as Digital Optics like Broadband Digital Forward (BDF) or Broadband Compressed Forward (BCF). In figure 17, the left side of the figure summarizes the functional layers for downstream DOCSIS and digital video. The right side of the image captures the platform or system architectures, or the network elements and what functions each contain. For example, I-CMTS or I-CCAP has a bar spanning from the top to the bottom of the functional diagram, thus all the functions are in those platforms. Likewise the far right bar, called Remote CCAP (R-CCAP) contains all the functions as well, but this has a red highlight around it meaning that this is all in a node enclosure. The color codes represent the highest layer of function in the node and any of the gray bars represent functions that will remain in the headend. At the top of the bar charts these are grouped by Centralized Access Architectures (CAA) and Distributed Access Architectures (DAA).

Please note that the two Centralized Access Architectures have RF outputs in the headend or primary hub, but these may be part of Digital Fiber Coax when a separate optical shelf is used in the headend to enable digital communications to and from the fiber node. In the CAA, all of the Edge QAM, CMTS, or CCAP functions and network elements remain intact maintaining the MAC and PHY layers in the headend. The DAA distributes the entire MAC and PHY functions or may distribute portions of the CCAP to the node keeping the remainder in the headend. Thus in DAA there is no CCAP RF ports in the headend.

## FTTN using Digital Fiber Coax (DFC) Arch. Six (6) Digital Fiber Coax (DFC) Architectures

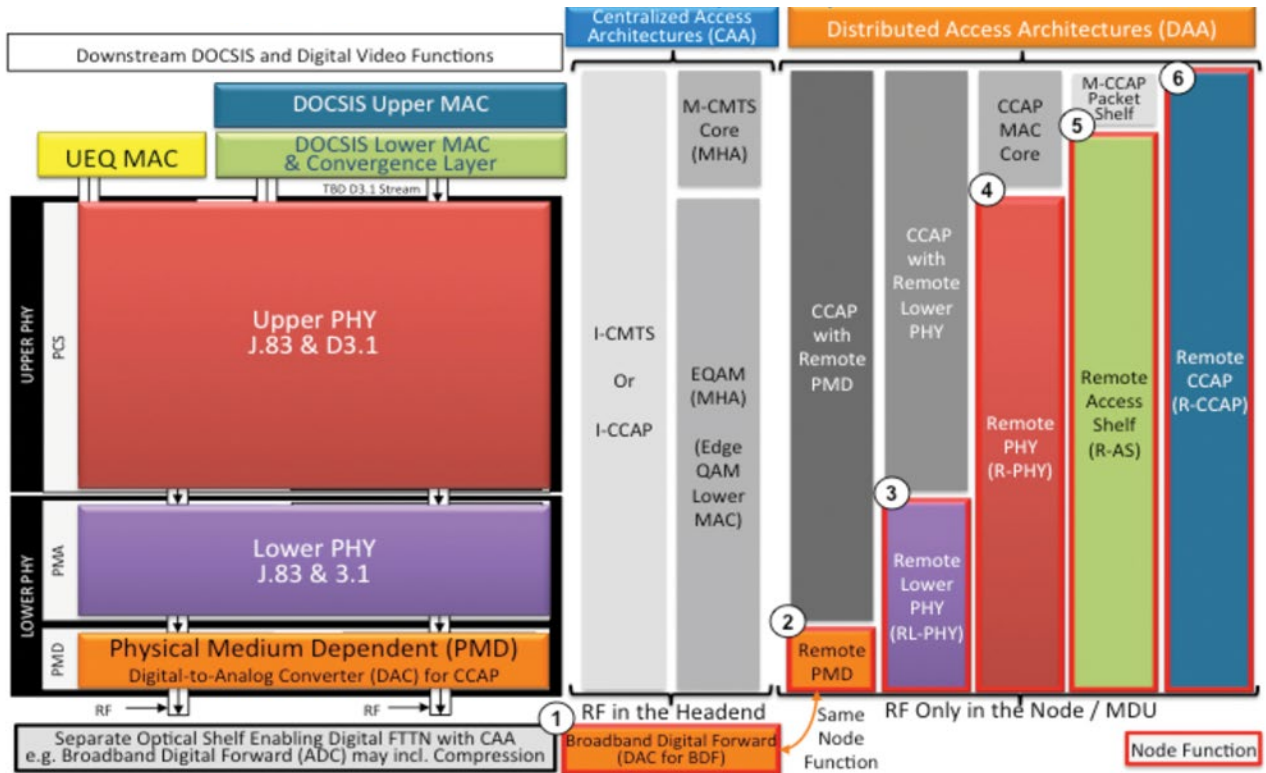

Figure 17: Platform / System Architectures (Headend + Node) MPEG-TS & DOCSIS Downstream

1. Broadband Digital: Assumes a separate optical shelf receiving RF sources from analog video, Edge QAM, CMTS, CCAP, RF Out-of Band, and RF Test equipment. The Broadband Digital equipment receives RF and digitizes the spectrum transported to or from the node. Key components of this process are the Analog-to-Digital Converter (ADC) and Digital-to-Analog Converter (DAC).

This approach allows transparency of the RF MAC/PHY technologies in the outside plant. This is in use today for the upstream called Broadband Digital Return (BDR) and this type of approach may be used in the downstream direction as well called Broadband Digital Forward (BDF). Suppliers may add innovations to reduce the capacity requirements imposed when the analog signal and spectrum is digitized. These are proprietary solutions today, but could easily be standardized. This approach is the “only” Remote PHY architecture that maintains the transparency of the underlining MAC/PHY technologies that travels through it and uses digital optics. Please refer to figure 18 through 21.

2. Remote PMD (R-PMD): The term PMD refers to the Physical Medium Dependent sub-layer of the PHY that contains the ADC/DAC (Analog-to-Digital or Digital-to-Analog). The PMD layer is part of the CMTS, Edge QAM or CCAP platforms. This is similar to Broadband Digital, however, this just removes the PMD layer in the CMTS, Edge QAM or CCAP platform, and places this function in the node or MDU location. This type of architecture has not been done in the cable space, but if desired could be called Remote Physical Medium Dependent (R-PMD).

We are suggesting the term Remote PMD, because this better defines the remote PHY layer that is placed in the node. The cable industry could define a standards based Remote PMD Architecture for the return and forward path similar to that, which was done when the PHY layer was removed from the CMTS in the Modular Headend Architecture (MHA). As in the case with Broadband Digital, suppliers may add innovations to reduce the capacity requirements imposed when the analog signal and spectrum is digitized and this could also become standardized. Please refer to figures 22 and 23.

3. Remote Lower PHY (RL-PHY): Remote Lower PHY is placed in the node where constellation symbols or groups of constellation symbols are received from the headend to the node lower PHY for modulation. This represents the modulation functions and is sometimes called Remote Mod. Remote Lower PHY is only an option for the downstream and not the upstream. Please refer to figures 24 and 25.
4. Remote PHY (R-PHY): This places the full PHY layer including the FEC, symbol generation, modulation, and DAC/ADC processing in the node. This is analogous to the Modular Headend Architecture (MHA), but of course different in many ways, such as timing and support for extreme separation of the MAC and PHY layers as well as support for DOCSIS 3.1 would have to be written. This approach could be called Remote PHY Architecture (RPA). Please refer to figure 26.
5. Remote - Access Shelf (R-AS): Places the entire "Edge QAM" MAC and PHY layer functions in the node. Video security and encryption may or may "not" be placed in the node. The Lower "DOCSIS" MAC functions for scheduling and the entire PHY functions are placed in the node. This could be referred to as the Remote Access Shelf. The M-CCAP Packet Shelf remains in the headend and performs the DOCSIS upper MAC functions while the M-CCAP Remote Access Shelf performs Edge QAM MAC and Lower DOCSIS MAC functions. Please refer to figure 27.
6. Remote CCAP (R-CCAP): Places the entire upper and lower MAC and PHY layer functions in the node. This places the CMTS, Edge QAM, and CCAP functions into the node. Please refer to figure 28.

## Example Platform Network Architectures

### Broadband Digital Return and Forward Architecture

In figure 18, please refer to the definition above called “Broadband Digital”. As a brief description, Broadband Digital Return and Forward will be a separate optical shelf that interfaces with devices with RF ports and digitizes the signals between the headend and node. Today, Broadband Digital is used only for the return path. In the figure the I-CCAP has all functions for video: DOCSIS J.83, DOCSIS 2.0, and DOCSIS 3.1, all in a single platform. However, a MHA could have been used with RF outputs in the headend. The key point for Broadband Digital is that RF interfaces remain in the headend and these devices interface with an optical shelf that enables a digital connection between headend and node. Like Amplitude Modulated (AM) optics used in HFC, Broadband Digital is completely transparent.

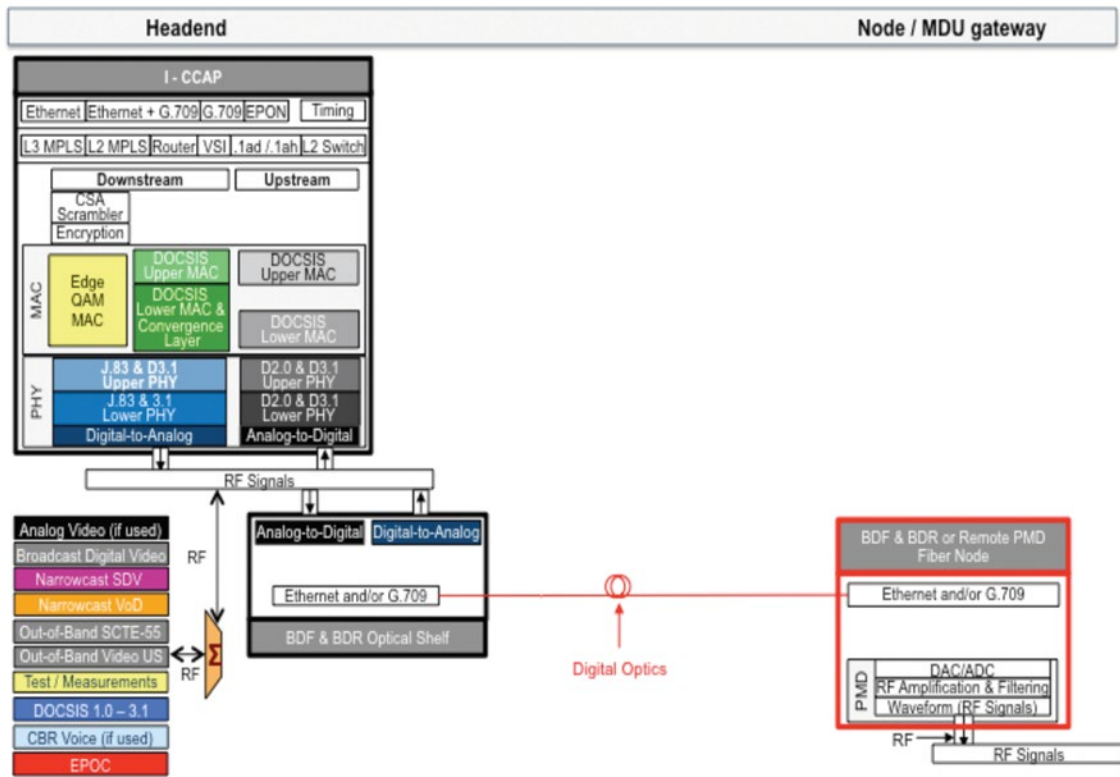

Figure 18: Broadband Digital Return and Forward Architecture

### Broadband Digital Forward or Broadband Compressed Forward

The use of Broadband Digital has been used in the return patch for many years. The use of Broadband Digital in the forward direction has not been a viable option, because of the large optical link to carry full spectrum, perhaps as high as 25 Gbps optical link to carry 1 GHz worth of spectrum. The introduction of the next evolution Broadband digital use compression technologies to reduce the overhead typically required to transport RF spectrum such perhaps approximately 800 MHz of spectrum may be carried in a 10 Gbps optical class link.



The use of Broadband Compressed Forward (BCF) could be used as part of Full Spectrum architecture or as part of the Broadcast Cast and Narrow Cast architecture. The use of Broadband Compressed Forward will enable high order modulation over long optical spans or distance, using of lots of optical wavelengths, and even in Narrow Cast architectures.

In the diagram below, the use of amplitude modulation optics is used with analog optics the distance and number of wavelength trade-off is illustrated.

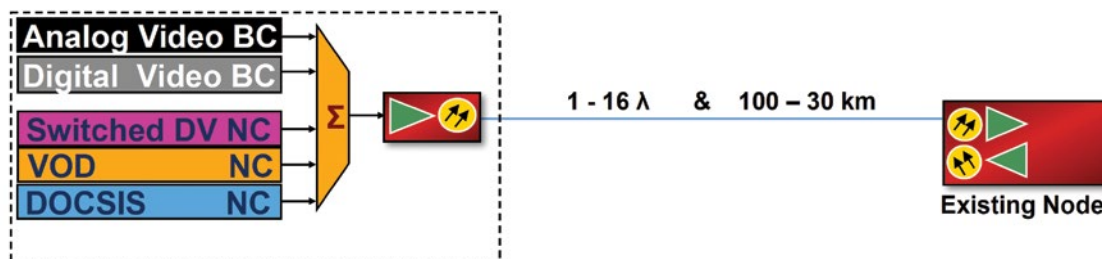

Figure 19: Amplitude Modulation Optics with Wavelength and Distance

The use of Amplitude Modulation (AM) Compared with Broadband Compressed Forward is that the services transported and the equipment in the headend used for HFC AM optical transport can be used for DFC use of BCF. The use of BCF will transport and MAC and PHY technology transparently. The uses of BCF can carrier analog services and out-of-band (OOB) signals.

BCF carries the services, leverages the existing headend data and video equipment, and the transparency of AM optics, but BCF has the benefits of digital transport. Similar to Remote PHY and Remote MAC and PHY discussed later in this paper, the use of BCF enables the high performance of any of the other DFC architecture such as: distance/number of wavelengths, pluggable optics modules with ease of setting, deploying and sparing.

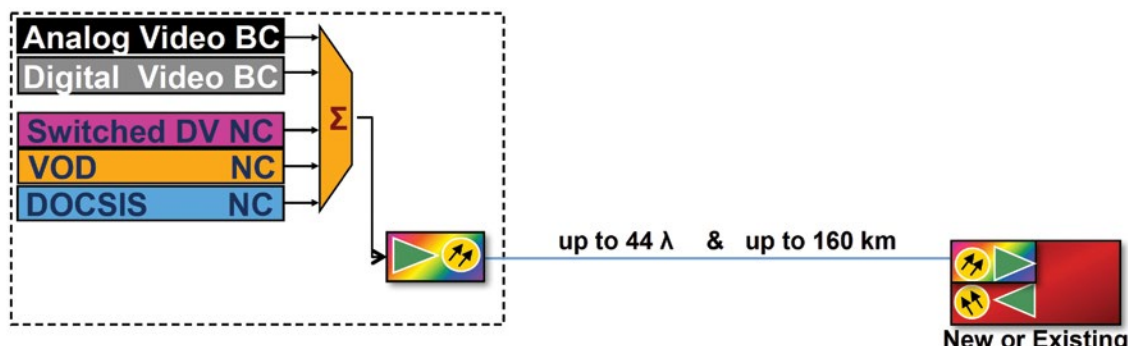

Figure 20: Broadband Compressed Forward (BCF) Integrates the Entire Legacy

The figure below illustrates the BFC will enable I-CCAP or MHA architectures to remain in place and even to continue to be deployed while enabling a digital option for these platform architecture should the DFC be desired. The RF combined with analog and digital video broadcast and CCAP narrowcast services are shown using the same digital optical link. The use of BCF and CCAP enable a digital option where and if needed at all, while keeping the CCAP functions only in the headend and very little intelligence in the outside plant node.

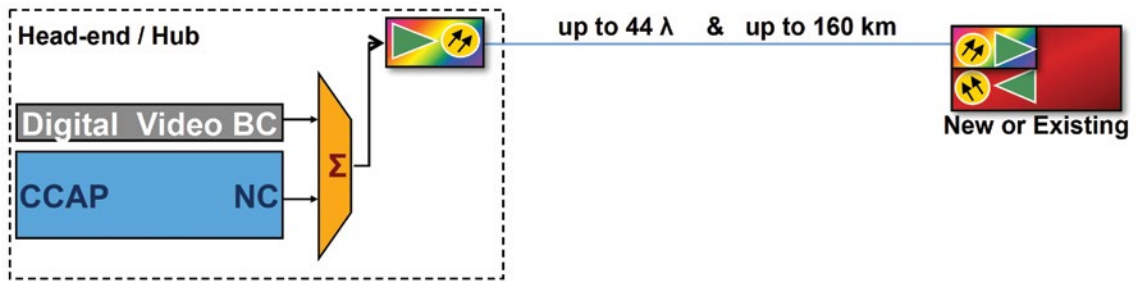

Figure 21: BCF Enables a Digital Transport for I-CCAP

### Remote PMD Architecture

In figure 22, please refer to the definition above called "Remote PMD (R-PMD)". In this architecture the term PMD refers to the Physical Medium Dependent sub-layer of the PHY that contains the ADC/DAC (Analog-to-Digital or Digital-to-Analog). The PMD layer is part of the CMTS, Edge QAM, or CCAP platforms. This is similar to Broadband Digital; however, this just removes the PMD layer in the CMTS, Edge QAM, or platform and places this function in the node or MDU location.

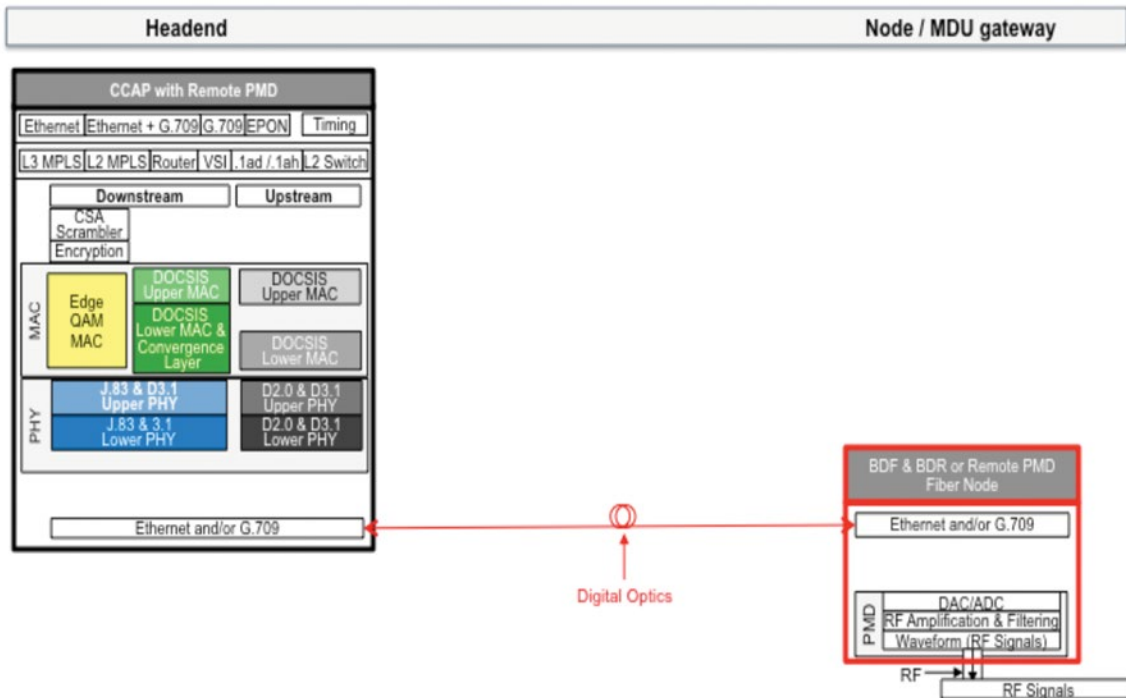

Figure 22: Remote PMD Architecture

In this example of Remote PMD Architecture, the Broadband Compressed Forward (BCF) gets subsumed into the CCAP shelf. The CCAP incorporates the BCF processing for part or the entire spectrum. The use of RF outputs in the CCAP is removed and replaced with standards based 16 G optical technology and if an MSO deployed BCF using a separate headend optical shelf to a BCF node, the existing BCF mode could be used.

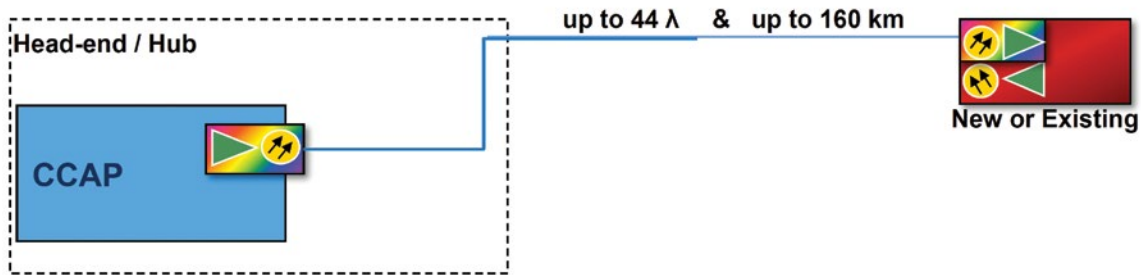

Figure 23: Remote PMD Architecture

### Remote Lower PHY (RL-PHY) Architecture

In figures 24 and 25 please refer to the definition above called "Remote Lower (RL-PHY)". These represent two different architectures to implement Remote Lower PHY. As with Remote PMD a portion of the PHY is removed from the headend and placed in the node location.

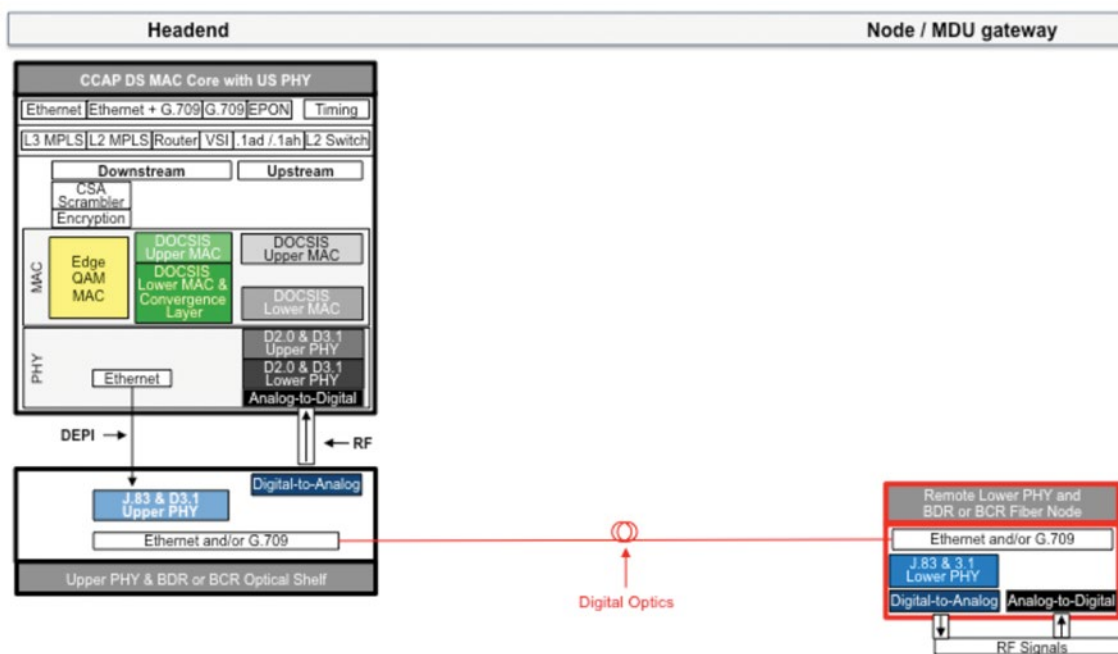

Figure 24: Remote Lower PHY and BDR Separate Headend Optical Shelf Architecture

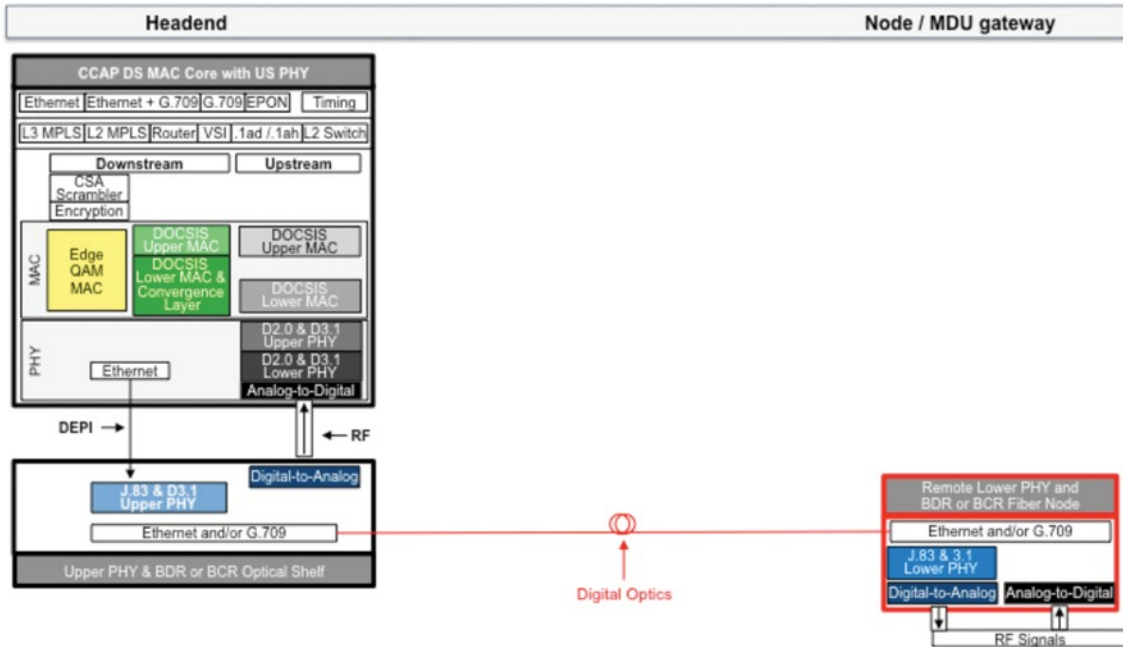

Figure 25: Remote Lower PHY CCAP and BDR Separate Headend Optical Shelf Architecture

### Remote PHY (R-PHY) Architecture

In figure 26, please refer to the definition above called "Remote PHY (R-PHY)". The architecture of using a CCAP MAC Shelf with a Remote PHY could be called Remote PHY Architecture (RPA), as this resembles in some ways the Modular Headend Architecture (MHA) defined by CableLabs.



Figure 26: Remote PHY Architecture (RPA)

### Remote Access Shelf Architecture

In figure 27, please refer to the definition above called "Remote Access Shelf (R-AS)". This is very similar to the Modular CCAP architecture that defined a Packet Shelf containing the DOCSIS Upper MAC functions and the Access Shelf (AS) containing the DOCSIS Lower MAC and full PHY functions.

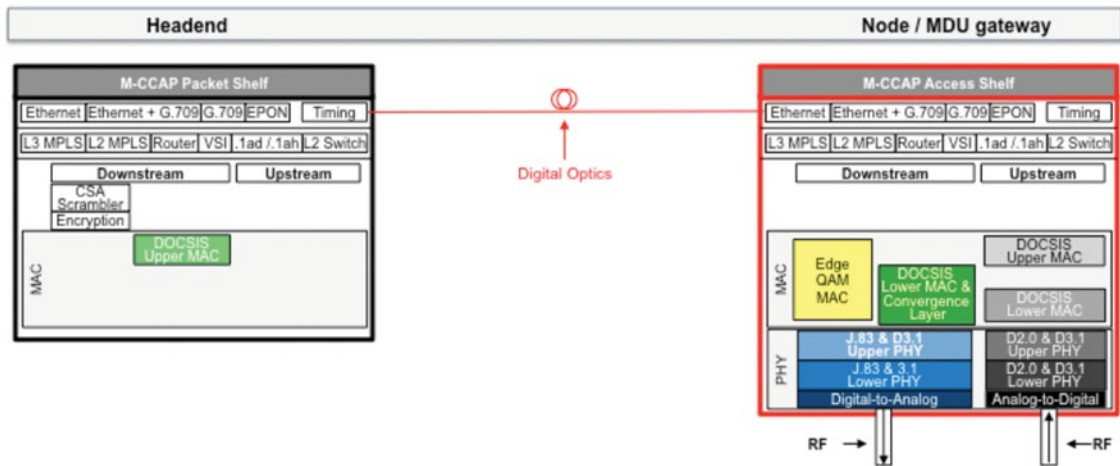

Figure 27: Remote Access Shelf (R-AS) Architecture

### Remote CCAP Architecture

In figure 28, please refer to the definition above called "Remote CCAP (R-CCAP)". This is the entire CCAP in the node minus the CSA Scrambler and Video Encryption.

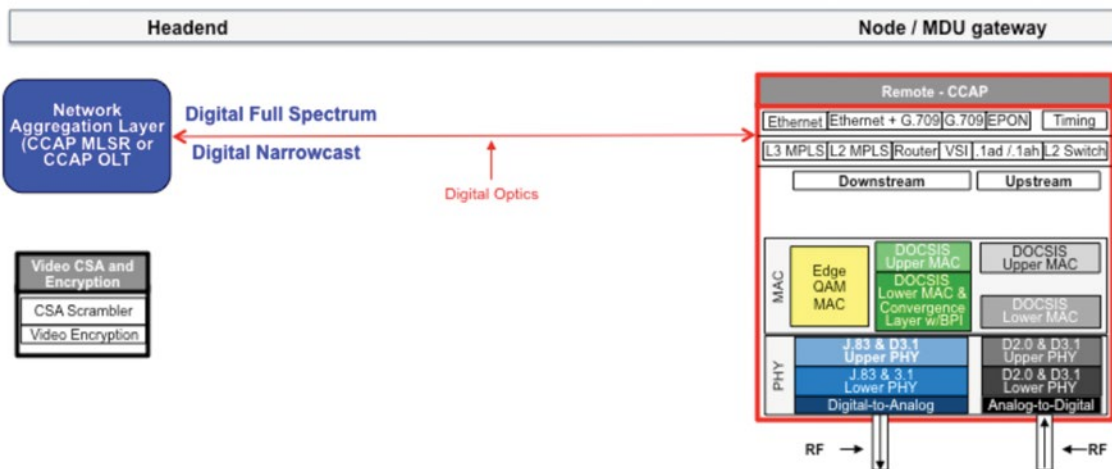

Figure 28: Remote CCAP (R-CCAP) Architecture

## Coaxial Segment Revenue Spectrum Capacity Considerations Detail

### Comparison of HFC AM Optics and DFC Architectures

This is likely one of the most critical analysis of the paper because there have been concerns in the industry of the ability for amplitude modulation optics to support that modulation formats that are defined in DOCSIS 3.1. The three figures below represent an analysis comparing Hybrid Fiber Coax (HFC) optics using amplitude modulation (AM) and two types of Digital Fiber Coax (DFC) CAA using Broadband Compressed Forward (BCF) and also DFC using Remote Gadget, and this refers to either Remote PHY CCAP or Remote CCAP.

It is assumed in the model will estimate the End of Line (EoL) performance and will then align that to the highest order modulation possible to support full spectrum using a given modulation order. Please note the assumptions below for each of the model comparisons.

Assumptions:

- Capacity Comparisons of HFC AM Optics vs. DFC BCF VS. DFC Remote Gadget
- Full Spectrum DOCSIS 3.1 Gen2 CCAP, up to 8 Lambdas, up to 1 GHz N+2, and 1.2 GHz N+0
- Capacity estimates based on modeled End of Line (EoL) performance with alignment to the highest order modulation possible
- Please note though EoL estimated may support given Modulation Order no DOCSIS 3.1 systems are available to confirm estimates

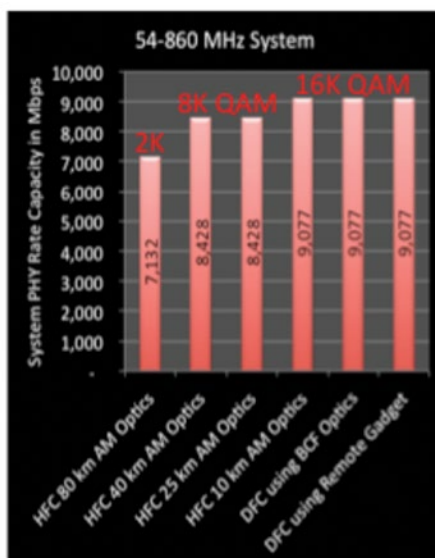

Figure 29: End-of-Line (EoL) Estimates and DOCSIS 3.1 Modulations in a 860 MHz Systems

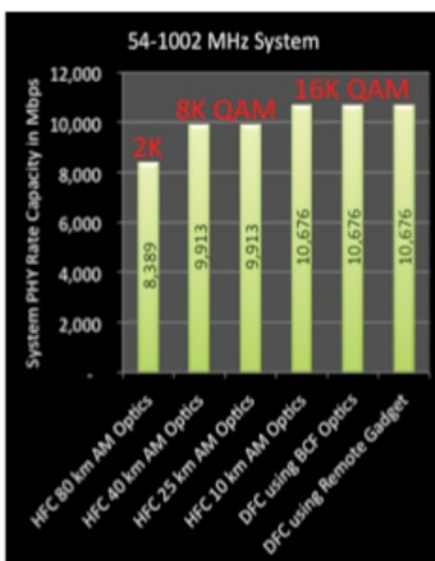

Figure 30: End-of-Line (EoL) Estimates and DOCSIS 3.1 Modulations in a 1 GHz Systems

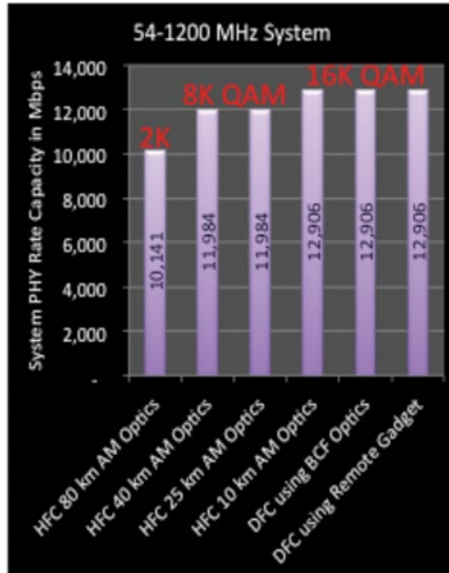

Figure 31: End-of-Line (EoL) Estimates and DOCSIS 3.1 Modulations in a 1.2 GHz Systems

A major takeaway from this section is that Hybrid Fiber Coax (HFC) use of amplitude modulation (AM) optics will enable the high order modulation defined in DOCSIS 3.1. It is unclear if the end-to-end systems (CCAP and CM) or if the operation can support such high order modulation in real-world, but it should be pleasing that the simple, transparent, and flexible HFC Fiber to the Node (FTTN) class of architecture will support the future needs of the MSO. This will allow the MSOs to keep intelligence out of the outside plant (OSP) until such a point where performance, distance, or wavelengths, demand the use of Digital Fiber Coax. The use of digital optics does not require the breakup and dismantling of the CCAP; if desired, an MSO could keep the CCAP MAC and PHY functions in the headend and/or primary hub site and use Broadband Digital Optics like Broadband Compressed Forward (BCF) to meet the performance of Remote Gadget.

## Optical Segment Wavelength Capacity Consideration Details

The use of Amplitude Modulated (AM) optics can take advantage of CWDM and DWDM optical transmission techniques to maximize the optical segment of the network. In a narrowcast overlay architecture, we assume as many as 40 wavelengths / lambdas per fiber, 80 QAMs of narrowcast spectrum, and a reach of approximately 100 km to the node. HFC optical distance will vary based on many factors, including narrowcast channel loading, the number of analog video channels, and many other factors. However, in the example above, the use of AM optics for full spectrum and the desire that the entire spectrum will enable the highest order modulation possible, will reduce the number of wavelengths.

In the model, we assumed that 8 wavelengths were possible for AM optics to enable the modulation orders and capacities of each system bandwidth. The use of digital optics will maximize the optical segment while enabling the high modulation orders; the wavelength capacity for digital optics may be between 3 to 4 times AM optics wavelength capacity. If digital optics uses CWDM supporting 16 lambdas and using DWDM supporting 44 lambda, then this is a combined up to 58 lambdas and at this level this is 7 times the AM optical wavelength capacity and enables the high order modulation at nearly any distance.

In some cases, fiber count is insufficient, regardless of the distance. Therefore, to avoid over lashing new fiber to service groups, separate wavelengths are placed on the fiber. The use of HFC analog optics today supports far fewer optical wavelengths than that which is supported using digital optical technology. This may be a challenge for HFC AM optics.

## Headend Space and Power Consideration Details

### Scaling Centralized Access Architectures

With the continued 50% growth rates in bandwidth capacities, some operators are concerned that they may need to continue to split nodes and need a dozen or more times the number of Service Groups (SG) than they have today. There is a fear among some that traditional CCAP boxes will not keep pace with this growth in SG. This could result in operators running out of both space and power in their existing Headend facilities. [ULM] studies this in detail.

While there are significant variations between headends, that paper focused on a conservative “normalized” headend footprint that is represented in the first row of Table 1. The model headend requires 10 racks of space today to support about 200 Service Groups (SG) using existing CMTS, EQAM, RF Combining, and Optic shelves. That’s an average of 20 SG per rack. This is the baseline for the analysis.

The next step is the migration to today’s CCAP platforms and existing optic shelf technology (row 2). This could squeeze 200 SG into 3 total racks. This uses 2013 technology of 56 SG per CCAP and optic rack density of 60 SG per 12 RU. That results in an average of 70 SG per rack, which results in a 3.5X improvement over our baseline configuration. This means that we might fit 700 SG into the existing 10-rack footprint.

A second generation traditional CCAP (row 3) might achieve at least 25% increase in SG density. This pushes the CCAP up to ~70 SG per chassis. At the same time, optic shelf rack density increases in the last year from 60 SG per 12 RU up to 80 SG per 12 RU. Using these two inputs, the next step in the CCAP evolution should get us down to two racks to support 200 SG. That’s an average of 100 SG per rack for a 5X increase over our baseline of today’s CMTS/EQAM based headends.

Configuration	Space Needed For ~200 SG	SG per 1 Rack	Relative Scale
2012 Headend – CMTS, EQAM, RF Combining, Optics	~10 Racks	~20 SG	1X
2013 Traditional CCAP (56 SG) + Optics Shelf (60 SG per 12 RU)	~3 Racks	~70 SG	3.5X
2nd Gen CCAP (~70 SG) + 2014 Optics Shelf (80 SG per 12 RU)	~2 Racks	~100 SG	5X
Future 2020 CCAP (~200 SG) + Optics Shelf (120 SG per 12 RU)	~1 Rack	~200 SG	10X

Table 1: CCAP Space Savings Example, CAA



The analysis in [ULM] shows that traditional CAA-based CCAP systems can just about quadruple densities of today's CCAP by the year 2020. That would put them around 200 SG per CCAP chassis. This combines with the expected continued advances in optical shelf rack densities to 80 SG per 8 RU. The result (row 4) achieves 200 SG in a single rack within this decade. That provides a 10X increase in SG growth within today's existing headend footprint.

In addition to this SG growth, D3.1 will also give a giant boost to the SG capacity. Starting from today's CCAP system that provides about 1 Gbps (i.e. 32 DOCSIS channels), D3.1 can provide more than 10 Gbps per SG. So, the bottom line is that traditional CAA-based headend systems can leverage CCAP + AM optic advances to get both a 10X increase in SG counts in conjunction with 10X increase in capacity per SG before the end of this decade.

### Headend Space for DAA

As was shown in [ULM], the primary limitation for SG density in CCAP is the RF connectors. For a DAA based headend system, the RF in the headend goes away. The DAA impact is shown in the expanded Table 2.

Our analysis shows that both BCF and Remote PHY can achieve roughly twice the SG density in the CCAP once the RF connector restriction is removed. This could allow SG densities of 400 SG per rack as shown in rows 5 and 6.

Configuration	Space Needed For ~200 SG	SG per 1 Rack	Relative Scale
2012 Headend – CMTS, EQAM, RF Combining, Optics	~10 Racks	~20 SG	1X
2013 Traditional CCAP (56 SG) + Optics Shelf (60 SG per 12 RU)	~3 Racks	~70 SG	3.5X
2nd Gen CCAP (~70 SG) + 2014 Optics Shelf (80 SG per 12 RU)	~2 Racks	~100 SG	5X
Future 2020 CCAP (~200 SG) + Optics Shelf (120 SG per 12 RU)	~1 Racks	~200 SG	10X
Future CCAP (~400 SG) + BCF/BCR	~0.5 Racks	~400 SG	20X
Future CCAP (~400 SG) + R-PHY	~0.5 Racks	~400 SG	20X
Future CCAP (~800 SG) + R-CCAP aggregation	~0.25 Racks	~800 SG	40X

Table 2: CCAP Space Savings Example, CAA + DAA

For R-CCAP, the entire MAC and PHY layers have been moved out of the existing headends. What's left in the headend or "cloud" from the data path perspective is primarily Ethernet aggregation. This provides further consolidation in headend space and roughly doubles the SG density compared to BCF/BCR and Remote PHY. This could push SG density up to 800 SG per rack for a 40X SG increase within today's existing space and power footprint.

## Summary: Side-By-Side Comparison HFC VS. DFC and CAA VS. DAA

Some of the most often asked questions by cable industry forward-looking planners reflect the key challenges the industry is facing for this decade and beyond. Some of these challenges and questions include:

### 1. Can Digital Fiber Coax (DFC) architectures maximize the coaxial segment revenue spectrum capacity?

#### Answers:

- Yes and No (yes, assuming extremely high modulations are possible in the real world)
- Yes, DFC may increase spectral capacity by 27% in 80 km spans and by 8% 25-40 km spans
- No, DFC and HFC AM optics up to 10 km may support the same modulation order

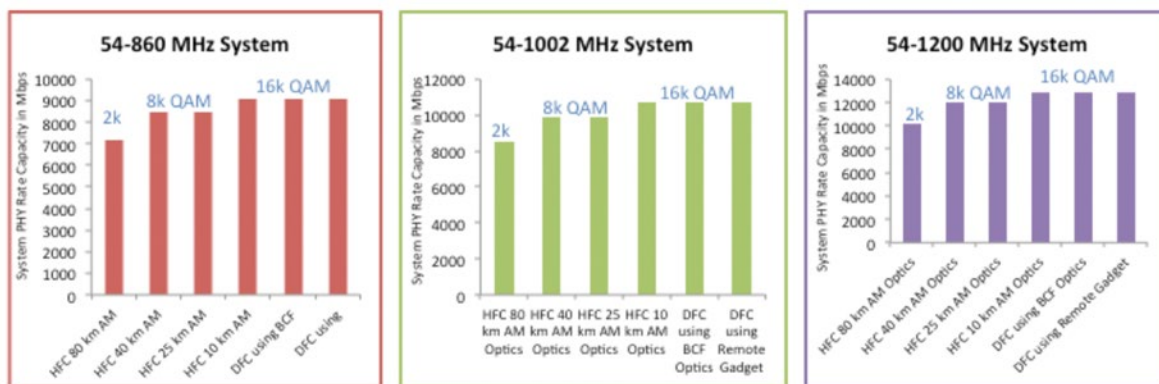

Figure 32: End of line (EoL) Estimates and DOCSIS 3.1 Modulations Several Cable Systems

#### Assumptions:

- Capacity Comparisons of HFC AM Optics vs. DFC BCF VS. DFC Remote Gadget
- Full Spectrum DOCSIS 3.1 Gen2 CCAP, up to 8 Lambdas, up to 1 GHz N+2, and 1.2 GHz N+0
- Capacity estimates based on modeled End of Line (EoL) performance with alignment to the highest order modulation possible
- Please note though EoL estimated may support given Modulation Order no DOCSIS 3.1 systems are available to confirm estimates

### 2. Can Digital Fiber Coax (DFC) architectures maximize the optical segment wavelength capacity?

#### Answer: Yes

- Digital Optics maximizes Optical Segment Wavelength Capacity between 3 to 4 times AM Optics Wavelength capacity
- Digital Optics using CWDM supports 16 lambdas and using DWDM supports 44 lambda with a combined up to 58 lambdas

### 3. Can Digital Fiber Coax (DFC) architectures maximize facility space, power, and cooling?

**Answer:**

- It Depends this may reduce the headend requirements and increases the OSP
- HFC or DFC with CAA will meet or exceed the service group growth projections in most cases
- DAA reduces space, power, and cooling in the headend, but increases these factors in the OSP

Access Architecture (HFC or DFC and CAA or DAA) Headend Equipment Types	Space Needed For~200 SG	SG per 1 Rack	Advance Scale
HFC using AM Optics and <b>CAA (CMTS)</b> Year 2012	~10 Racks	~20 SG	1X
HFC using AM Optics and <b>CAA (CCAP Gen1)</b> Year 2013	~3 Racks	~70 SG	3.5X
<b>DFC</b> using Broadband Digital and <b>CAA (CCAP Gen2)</b> ~2016	~2 Racks	~100 SG	5X
<b>DFC</b> using Broadband Digital Tx/Rx and <b>CAA (CCAP)</b> ~2020	~1 Racks	~200 SG	10X
<b>DFC</b> using <b>DAA with CCAP Remote PMD</b>	~0.5 Racks	~400 SG	20X
<b>DFC</b> using <b>DAA with CCAP MAC Core and Remote PHY</b>	~0.5 Racks	~400 SG	20X
<b>DFC</b> using <b>DAA with Remote CCAP Aggregation</b>	~0.25 Racks	~800 SG	40X

Table 3: CCAP Space Savings Example, CAA + DAA

Table 3 assumes ~32 RU per rack are available after power supplies and the table does not show continued improvements in HFC AM Optical Headend Densities (contact CommScope)

### 4. Can Digital Fiber Coax (DFC) architectures maximize long links and facility consolidation?

CAA with AM Optics limits long links & headend consolidation

- 10 km End of Line support estimates of 16K QAM in full spectrum
- 40 km End of Line support estimates of 8K QAM in full spectrum
- 80 km End of Line support estimates of 2K QAM in full spectrum

DOCSIS MAC in the headend limits long links & headend consolidation

- 160 km limit when DOCSIS MAC is in the headend (CAA BCF or DAA R-PHY)
- The DOCSIS MAC in the HE/Hub “plus” Digital Optics exceeds AM optics without reducing use of high order modulation but the DOCSIS MAC to CPE separation shall not exceed 160 km, thus DOCSIS is the limiting factor

DAA with Remote Access Shelf (R-AS) or Remote CCAP (R-CCAP)

- Over 160 km & virtually no headend-to-customer limit (Remote Access Shelf R-AS or Remote CCAP R-CCAP)
- Placing the DOCSIS “MAC” in the node / MDU removes the DOCSIS 160 km distance limitation, so now digital optics performance vs. cost vs. facility consolidation will determine how far beyond 160 km is practical

## 5. Can Digital Fiber Coax (DFC) architectures maximize the economics of OPEX and CAPEX?

**Answer: It is too early to tell for sure when weighing all factors**

Identified previous benefits of DFC Drivers will improve the Economics (OPEX and/or CAPEX):

- Coax Segment: capacity (b/s/Hz) range from zero to small (depends)
- Optical Segment: wavelength are maximized with DFC
- Space: I-CCAP with AM optics densities will exceed SG growth rates
- Long Links and Headend Consolidation: is expanded with DFC without reducing coaxial capacities

End-to-End Solution OPEX and CAPEX:

- Increase in service group OSP plant power and battery suppliers
- Overall failure rates could increase with intelligence in the OSP
- MTTR / MTTD may increase with more intelligence in the OSP
- Benefits of sharing optical transport link to carry other technologies
- End-to-End cost could improve with standard digital optics.
- True costs comparisons are unknown and validated

## Conclusions

The use of Digital Forward and Return may place the lowest layer of the PHY in the node, like the ADC and DAC to the entire PHY and may also place the entire MAC and PHY in the node. It is too early to tell which Remote Access Layer architecture is best to enable digital optics. It should be noted that AM optics will support high order modulations in the majority of MSO FTTN applications today, but there are limitations. The use of digital forward and return independent of which architecture may not be desired or used by all MSOs and even within an MSO. Further industry research is needed to determine the best DFC architecture.

## Conclusion Summaries

Digital Fiber Coax (DFC) is just an additional tool in the MSO tool bag:

- CAA using Broadband Compressed Forward or
- DAA with Remote Gadget (Remote PHY or Remote CCAP)
- The DFC solutions could just be used where, when, and if needed

Keeping the CCAP intelligence together and in the headend:

- Keeps the OSP simple and transparent
- Enables the HFC optics and CAA option
- Enables the DFC (Broadband Compressed Forward) and CAA option

DFC may be used as a tool in extreme cases:

- Where there is a need for Massive Service Group (SG) expansion
- Example: one (1) node per 500 HHP moves to 20 nodes per 500 HHP SG
- If locations are fiber starved and/or headend space constraints exist

Where there is a need for extremely long distance between facility and fiber node:

- Broadband Compressed Forward or Remote PHY extends reach to 160 km
- Remote CCAP (MAC/PHY in the Node) extends reach beyond 160 km to enable massive headend consolidation virtually without limits

A major takeaway from this section is that Hybrid Fiber Coax (HFC) use of amplitude modulation (AM) optics will enable the high order modulation defined in DOCSIS 3.1.

It is unclear if the end-to-end systems (CCAP and CM) or if the operation can support such high order modulation in the real-world, but it should be pleasing that the simple, transparent, and flexible HFC Fiber to the Node (FTTN) class of architecture will support the future needs of the MSO. This will allow the MSOs keep intelligence out of the outside plant (OSP) until such point where performance, distance, or wavelengths demand the use of Digital Fiber Coax.

The use of digital optics does not require the breakup and dismantling of the CCAP. If desired, an MSO could keep the CCAP MAC and PHY functions in the headend and/or primary hub site and use Broadband Digital Optics like Broadband Compressed Forward (BCF) to meet the performance of Remote Gadget. We could also consider the use of Remote CCAP in the extreme cases where AM optics and BCF and Remote PHY cannot meet the needs of extremely long fiber spans for headend consolidation and if there are serious space concerns.

#### Meet One of Our Experts: Mike Emmendorfer

Mike Emmendorfer serves as Senior Director, Systems Engineering and Architecture, in the Office of the CTO at ARRIS. In this role, he is responsible for forward-looking architecture and strategy to determine the viability of new products and technologies. Projects have included DOCSIS enhancements, EPOC, EPON, Metro Ethernet Forum, Wireless, RFoG, Remote Access Architectures, and IPTV. Recently, Mike was lead author in a series of ARRIS publications, presented at numerous conferences spanning the globe during 2011 and 2012 that defined the next generation of DOCSIS, which later became DOCSIS 3.1. The final release of the "Next Generation – Cable Access Network (NG-CAN)" series of papers and publications in February 2012 defined the core features set for what later become DOCSIS 3.1. Later, in May 2012 for the NCTA – Cable Show, Mike teamed up with technical leaders from Cisco, Intel, and Motorola to co-author "Mission is Possible: An Evolutionary Approach to Gigabit-Class DOCSIS", and it was this joint paper that launched DOCSIS 3.1.

## REFERENCES

[ULM] – "Scaling Traditional CCAP To Meet The Capacity Needs Of The Next Decade"; J. Ulm, J. Finkelstein, S. Rahman, J. Salinger, The Cable Show Spring Technical Forum 2014

CommScope pushes the boundaries of communications technology with game-changing ideas and ground-breaking discoveries that spark profound human achievement.

We collaborate with our customers and partners to design, create and build the world's most advanced networks. It is our passion and commitment to identify the next opportunity and realize a better tomorrow. Discover more at [commscope.com](https://commscope.com)

**COMMSCOPE®**

---

[commscope.com](https://commscope.com)

Visit our website or contact your local CommScope representative for more information.

© 2019 CommScope, Inc. All rights reserved.

Unless otherwise noted, all trademarks identified by ® or ™ are registered trademarks, respectively, of CommScope, Inc. This document is for planning purposes only and is not intended to modify or supplement any specifications or warranties relating to CommScope products or services. CommScope is committed to the highest standards of business integrity and environmental sustainability with a number of CommScope's facilities across the globe certified in accordance with international standards, including ISO 9001, TL 9000, and ISO 14001. Further information regarding CommScope's commitment can be found at [www.commscope.com/About-Us/Corporate-Responsibility-and-Sustainability](https://www.commscope.com/About-Us/Corporate-Responsibility-and-Sustainability).

WP-113959-EN (11/19)