

STOP!

Don't Connect Unless You Inspect!

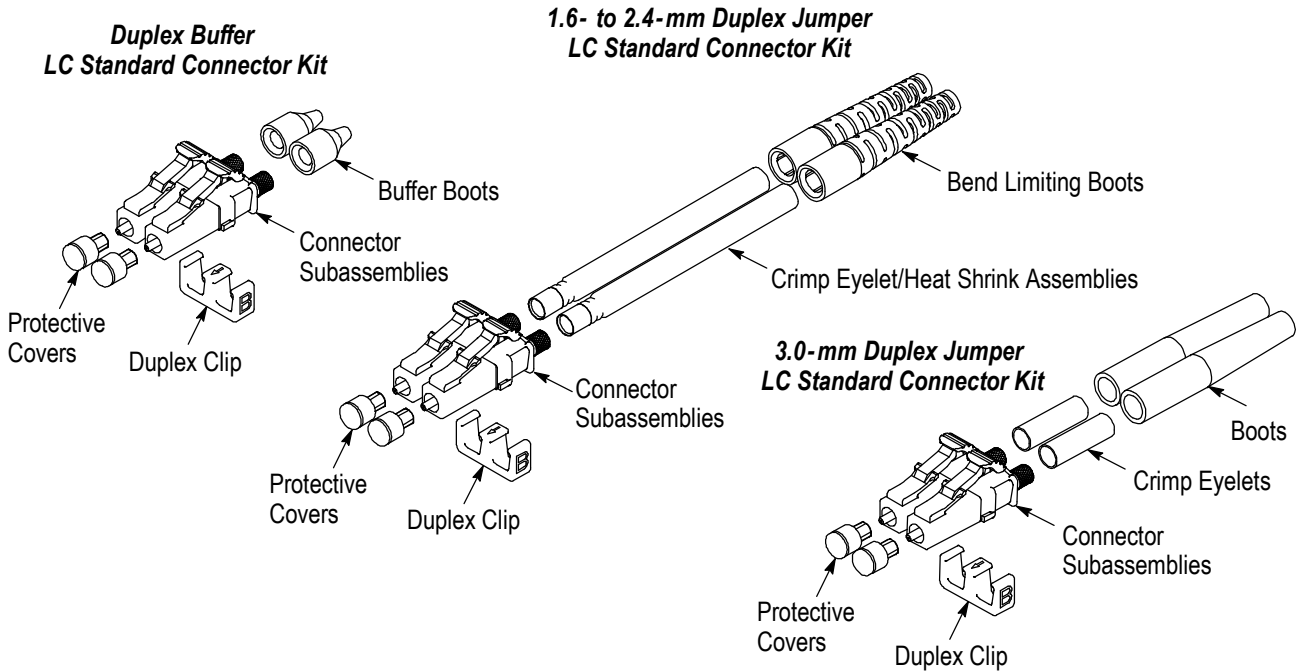

Figure 1

1. INTRODUCTION



Numerical values in this instruction sheet are in metric units [with U.S. Customary units in brackets]. Figures are not drawn to scale.

These connector kits are used in telephone company central offices, CATV head-ends, interbuilding backbones, and customer premise applications.

The connectors accept 250- μ m coated and 900- μ m buffered fiber and 1.6- to 2.4-mm and 3.0-mm jacketed fiber optic cable. With the use of the field-installable duplex clip, all simplex connectors can be joined into a duplex form. This instruction sheet covers the termination, inspection, and cleaning of these connectors.

Read these instructions thoroughly before starting assembly.

Reasons for reissue of this instruction sheet are provided in Section 7, REVISION SUMMARY.

2. DESCRIPTION (Refer to Figure 1)

Each simplex buffer connector kit consists of a connector subassembly, a protective cover, and a boot. Each duplex buffer connector kit consists of two of each of these components and a duplex clip.

Each 1.6- to 2.4-mm simplex jumper connector kit consists of a connector subassembly, a protective cover, a crimp eyelet/heat shrink assembly, and a bend-limiting boot. Each duplex jumper connector kit consists of two of each of these components and a duplex clip.

Each 3.0-mm simplex jumper connector kit consists of a connector subassembly, a protective cover, a crimp eyelet, and a boot. Each duplex jumper connector kit consists of two of each of these components and a duplex clip.

3. ASSEMBLY PROCEDURE

3.1. Tools and Consumables

The following tools and consumables are required for assembling, cleaning, and inspecting the connector kits (the related instruction sheet is in parentheses).

NOTE  *The connector kits are provided with a protective cover installed onto the connector subassembly. Keep the cover in place until ready for installation.*

A. Tools

- Miller Strip Tool 1754708-1
- Aramid Shears 1278637-1
- Cable Preparation Template 1588756-1 ■ ‡
- LC 900-µm Fiber Protector 1457630-1 ■
- LC Jumper Fiber Protector 1457630-2 ■
- Fiber Optic Sapphire Scribe Tool 504064-1 (408-4293)
- LC/SC/FC Die Set 1588175-1 ■ ‡
- PRO-CRIMPER® III Hand Tool Frame Assembly 58532-1 (408-4020)
- Heat Cure Oven Assembly 502134-1 (120 Vac) or 502134-2 (240 Vac) (408-9460)
- Oven Block Assembly 1457628-1 ■
- Fiber Optic Inspection Microscope (200 ×) 1754767-1
- 1.25-mm Universal Microscope Adapter 1754765-1 ■ ‡
- Polishing Bushing 1754074-1 ■ ‡
- Polishing Plate 501197-1
- Polishing Pad 501523-1

NOTE  *LC Termination Kits 1754462-1 and 1754603-1 are used to expand Professional Installer's Kit 501258-[] in order to terminate the LC connector.*

B. Consumables

- EPO-TEK™ 353-ND Epoxy 504035-1 or Loctite™ 648 anaerobic adhesive and Loctite 7649 activator (recommended)

NOTE  *Refer to Material Safety Data Sheet (MSDS) 125-6353 for characteristics, reactivity data, and handling of the epoxy.*

- Epoxy Applicator Kit 501473-3 (If using epoxy)
- Alcohol pads or isopropyl alcohol and lint-free cloths
- 9-µm Polishing Film 1374484-1 ■ ‡
- 5-µm Polishing Film 228433-8 (light gray)
- Fine Diamond Polishing Film 503887-1 (green or lavender) ■ ‡
- 0.3-µm Polishing Film 228433-5 (white)

3.2. Selection of Epoxy or Anaerobic Adhesive

Choose the epoxy or adhesive:

- The recommended epoxy is packaged in pre-measured bags. It will cure between 115° and 120° C [239° and 257° F] in 30 minutes.
- The recommended anaerobic adhesive is packaged in two bottles (adhesive and activator). It will cure at 22° C [71.6° F] in approximately three minutes.

3.3. Prepare the Cable

DANGER  *TO AVOID PERSONAL INJURY, ALWAYS wear eye protection when working with optical fibers. NEVER look into the end of terminated or unterminated fibers.*

DANGER  *Laser radiation is invisible but can damage eye tissue. Never eat, drink, or smoke when working with fibers. This could lead to ingestion of glass particles.*

DANGER  *BE VERY CAREFUL to dispose of fiber ends properly. The fibers create slivers that can easily puncture the skin and cause irritation.*

■ Included in LC Termination Kit 1754462-1 (for use with epoxy and adhesive)

‡ Included in LC Termination Kit 1754603-1 (for use with adhesive)

A. 250- μ m Coated Fiber and 900- μ m Buffered Fiber

1. Slide the buffer boot (small diameter end first) onto the fiber or buffer. See Figure 2.
2. Using the combination strip tool, strip the coated or buffered fiber using the cable preparation template (dimension is to scale) or use the dimension given in Figure 3, exposing the glass cladding.
3. Using the alcohol pad or lint-free cloth dampened with alcohol, clean the glass cladding to remove any coating residue.

CAUTION NEVER clean the buffer or fiber with a dry cloth.



NOTE For optimum results, the activator must be applied properly and allowed to dry.



B. 1.6- to 2.4- mm and 3.0- mm Jacketed Cable

1. Slide the boot (small diameter end first) onto the cable. Then slide the crimp eyelet/heat shrink assembly (heat shrink end first) or crimp eyelet onto the cable. Refer to Figure 2.

NOTE If duplex cord is used, unzip the jacket into separate cords at least 230 mm [9.0 in.] from the end of the cable.



Preparing the Cable

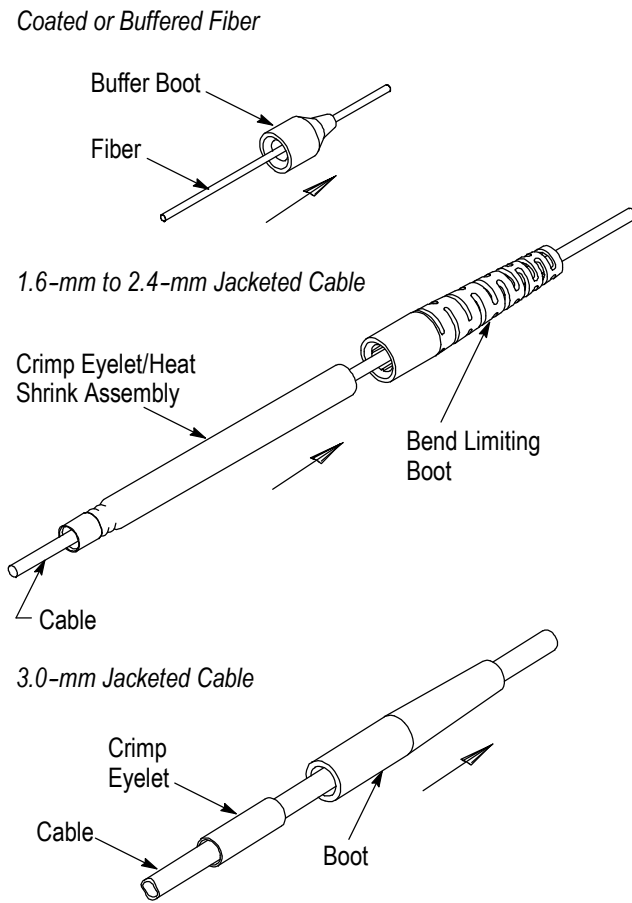

Figure 2

2. Using the combination strip tool and Aramid shears, strip the cable using the cable preparation template (dimensions are to scale) or use the dimensions given in Figure 4, exposing the glass cladding.
3. Using the alcohol pad or lint-free cloth dampened with alcohol, clean the glass cladding to remove any coating residue.

Note: Illustration Not to Scale
Dimension is in millimeters.

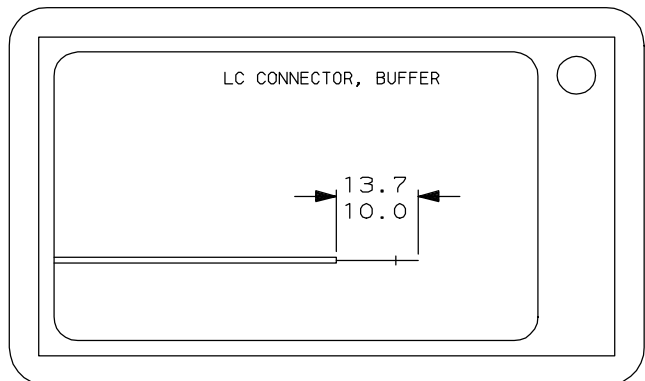



Figure 3

CAUTION NEVER clean the buffer or fiber with a dry cloth.



4. If using the anaerobic adhesive, dip the fiber and buffer into the activator or apply the adhesive using the brush. Allow 30 seconds for the activator to dry.

NOTE For optimum results, the activator must be applied properly and allowed to dry.



4. If using the anaerobic adhesive, dip the fiber and buffer into the activator or apply the adhesive using the brush. Allow 30 seconds for the activator to dry.

Note: Illustration Not to Scale
Dimensions are in millimeters.

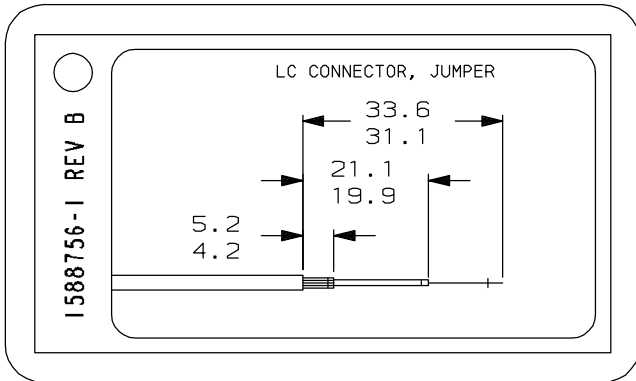
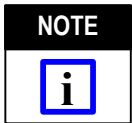

Figure 4

3.4. Prepare and Apply the Epoxy or Adhesive

A. Preparation of Epoxy

1. Remove the separating clip from the bag of epoxy and, using the epoxy mixer, mix the epoxy inside the bag thoroughly for 2 minutes.



When mixed properly, the epoxy should have a uniform, translucent, amber color.

2. Using the epoxy applicator kit, install the needle tip onto the epoxy applicator. Make sure that the tip is secure. Remove the plunger.
3. Cut the epoxy bag diagonally at one corner. Squeeze the epoxy into the back of the applicator. Re-assemble the plunger. Loosen, but do not remove, the cap. Hold the applicator vertically (with needle tip upward), and slowly push the plunger until the entrapped air escapes and a bead of epoxy appears at the tip. Remove the cap.
4. Using the alcohol pad or alcohol-dampened lint-free cloth, clean the tip of the applicator needle.

B. Preparation of Adhesive

1. Install the needles onto the two applicators, making sure they are secure.
2. Remove the plunger from one of the applicators, and load the adhesive into the back of the plunger. Re-install the plunger.
3. Holding the applicator vertically (with needle tip upward), allow the adhesive to drain away from the needle then slowly push the air out of the

applicator until a bead of adhesive appears at the tip of the needle.

4. Using the second applicator for the activator. With the plunger fully forward, draw a small amount (approximately 3 to 5 ml [.101-.169 oz]) of activator into the applicator.

3.5. Apply the Epoxy or Adhesive

1. Remove the protective cover from the connector subassembly.
2. If using epoxy, install the fiber protector onto the connector subassembly as shown in Figure 5.

Installing the Fiber Protector (For Use with Epoxy Only)

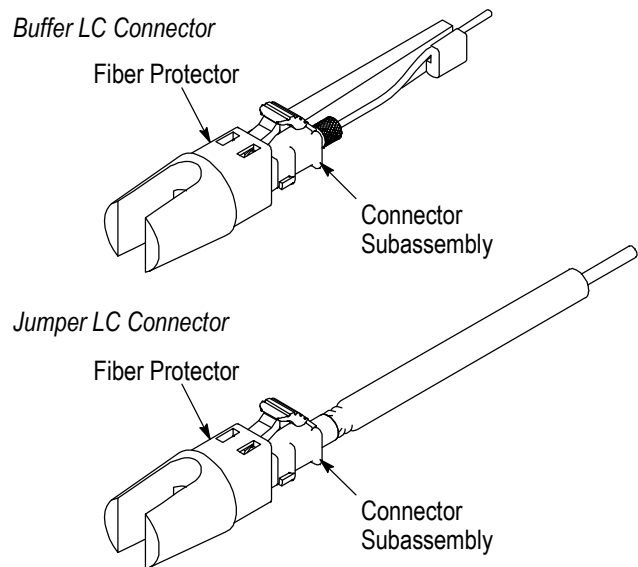

Figure 5

3. Hold the connector subassembly in an upright position, and insert the tip of the needle into the rear body and support tube of the connector subassembly until the tip of the needle touches the base of the ferrule. Refer to Figure 6.
4. Keeping the tip of the needle against the base of the ferrule, *slowly* inject the epoxy or adhesive into the connector subassembly until a small bead of epoxy or adhesive exits from the endface of the ferrule. See Figure 6.
5. Withdraw the applicator slightly (approximately 1.0 mm [.04 in.]), hold for one second, then retract the needle quickly *without* injecting any epoxy or adhesive into the connector subassembly.



If too much epoxy or adhesive is injected, the connector subassembly will not function properly.

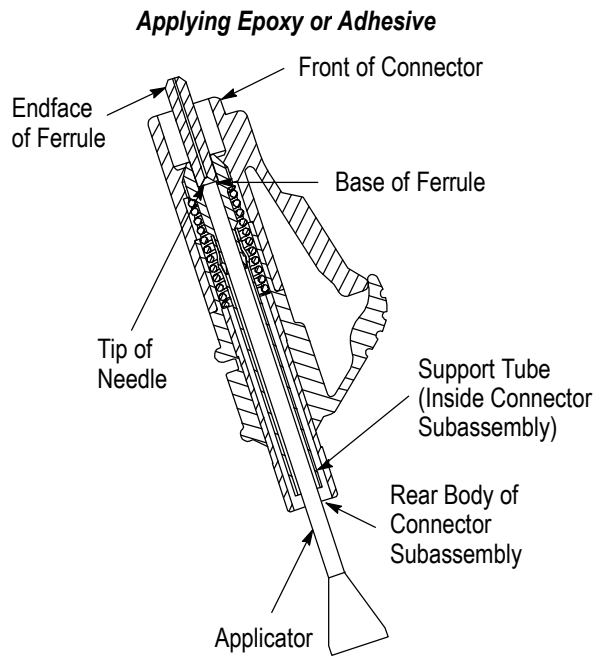

Figure 6

3.6. Terminate the Fiber

A. 250- μ m Coated Fiber and 900- μ m Buffered Fiber

1. Taking care not to break the fiber, insert the fiber into the rear body and support tube of the connector subassembly until the fiber buffer bottoms on the base of the ferrule. The end of the cable jacket should be just short of the rear body and the fiber should extend approximately 6.4 mm [.25 in.] from the endface of the ferrule.

2. With the buffer gripped behind the connector subassembly, lightly bias the buffer forward to form a slight bend as shown in Figure 7. Then insert the buffer into the recessed clamping groove of the cure protector.

B. 1.6- to 2.4-mm Jacketed Cable

1. Taking care not to break the fiber, insert the fiber into the rear body and support tube of the connector subassembly until the fiber buffer bottoms on the base of the ferrule. The end of the cable jacket should be just short of the rear body and the fiber should extend approximately 6.4 mm [.25 in.] from the endface of the ferrule. See Figure 8, Detail A.

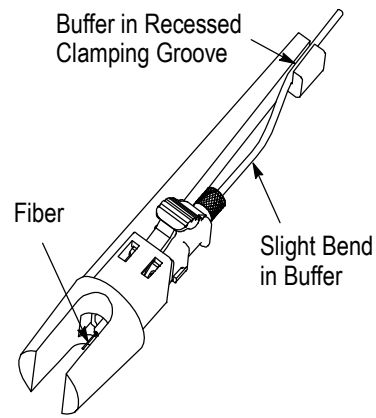

Figure 7

2. Uniformly distribute the cable strength members around the rear body of the connector subassembly. See Figure 8, Detail B.
3. Slide the crimp eyelet/heat shrink assembly over the strength members until it bottoms against the connector subassembly. See Figure 8, Detail C.

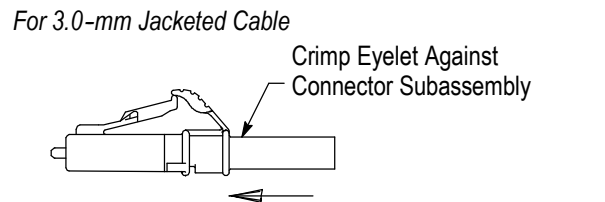
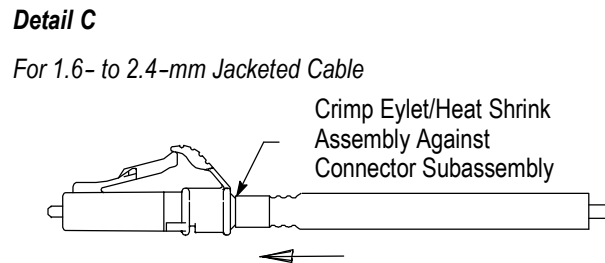
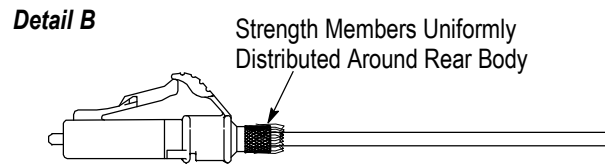
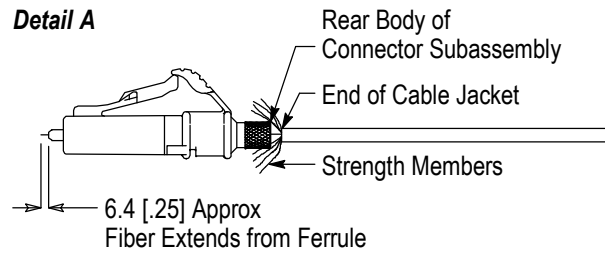

Figure 8



CAUTION DO NOT allow the cable strength members to enter the connector subassembly.

Crimping Heat Shrink Assembly
For 1.6- to 2.4-mm Jacketed Cable

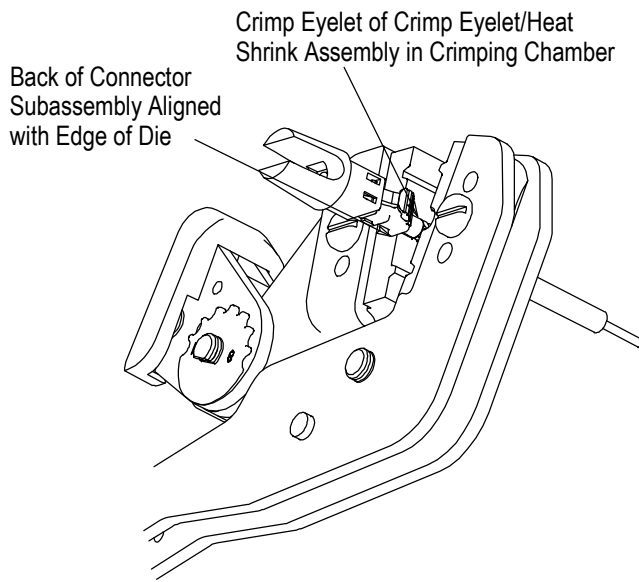

Figure 9

4. Install the die into the hand tool frame. Position the crimp eyelet of the crimp eyelet/heat shrink assembly into the crimping chamber of the die. See Figure 9.

5. Hold the connector subassembly in place, and actuate the tool. The strength members should be held in place.

6. Remove the assembly from the tool, and check that the crimp is straight and even, and centered on the crimp eyelet of the crimp eyelet/heat shrink assembly.

C. 3.0-mm Jacketed Cable

1. Taking care not to break the fiber, insert the fiber into the rear body and support tube of the connector subassembly until the fiber buffer bottoms on the base of the ferrule. The end of the cable jacket should be just short of the rear body and the fiber should extend approximately 6.4 mm [.25 in.] from the endface of the ferrule. See Figure 8, Detail A.



CAUTION DO NOT allow the cable strength members to enter the connector subassembly.

2. Uniformly distribute the cable strength members around the rear body of the connector subassembly. See Figure 8, Detail B.

3. Slide the crimp eyelet over the strength members until it bottoms against the connector subassembly. See Figure 8, Detail C.

4. Install the die into the hand tool frame. Position the crimp eyelet into the crimping chamber of the die. Make sure that the back of the connector subassembly is aligned with the edge of the die. See Figure 10, Detail A.

5. Hold the connector subassembly in place, and actuate the tool. The strength members should be held in place.

6. Again, position the crimp eyelet into the crimping chamber of the die. Make sure to align the end of the crimp eyelet (cable jacket side) with the edge of the die. See Figure 10, Detail B.

7. Hold the connector subassembly in place, and actuate the tool.

Crimping Crimp Eyelet

For 3.0-mm Jacketed Cable

Detail A

Crimp Eyelet in Crimping Chamber

Back of Connector Subassembly Aligned with Edge of Die

Detail B

Back of Eyelet Aligned with Edge of Die

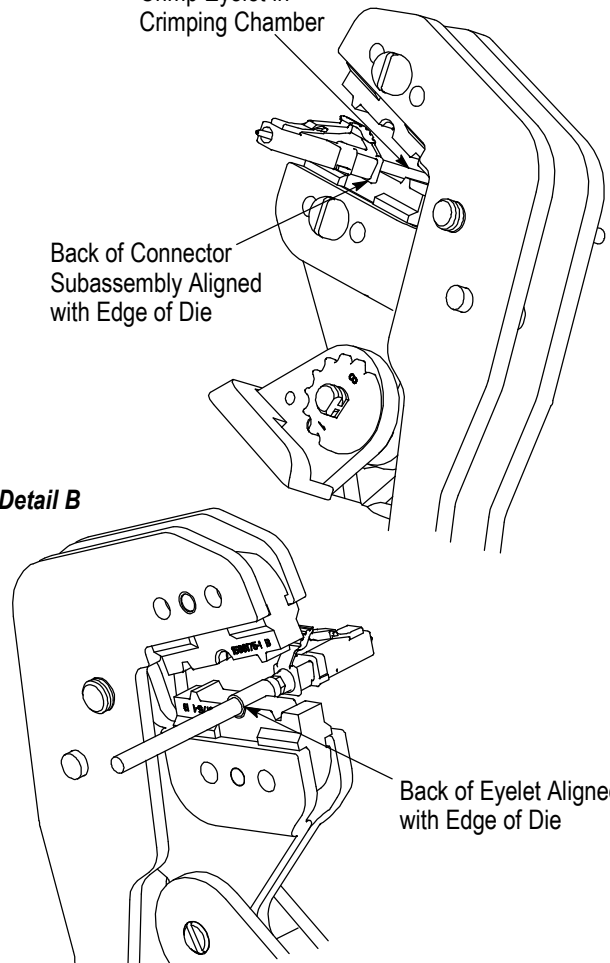



Figure 10

8. Remove the assembly from the tool, and check that the crimp is straight and even, and centered on the crimp eyelet.

3.7. Cure the Epoxy

A. Epoxy

1. Remove any excess epoxy from the connector subassembly.

CAUTION  Excess epoxy must be removed **BEFORE CURING**; otherwise, excess epoxy will be difficult to remove after curing.

2. Place the connector subassembly (with attached cure protector) in the heat cure oven according to the instructions packaged with the oven. Refer to Figure 11. Cure the epoxy between 115° and 120° C [239° and 257° F] for a minimum of 15 minutes.

This step will also shrink the crimp eyelet/heat shrink assembly (of the jumper connector kit).

CAUTION  To avoid damage to the assembly, **DO NOT** expose assembly to excessive temperatures.

3. After curing, grasp the cable, and gently lift the assembly out of the oven. The assembly will be **HOT**—allow sufficient time for the assembly to cool before proceeding.

CAUTION  To avoid damage to the assembly, the assembly must be allowed to cool.

B. Adhesive

1. Using the applicator, dispense a drop of activator over the bead of the adhesive on the endface of the ferrule.

2. Allow the adhesive to cure at an ambient room temperature of 22° C [71.6° F] for approximately 1 to 3 minutes.

NOTE  For optimum results, the adhesive must be applied properly and allowed to cure.

3. Using the heat gun, evenly heat the heat shrink of the crimp eyelet/heat shrink assembly until it shrinks into place. **DO NOT** overheat.

CAUTION  Overheating can cause fiber bending, breakage, or high insertion loss.

3.8. Cleave the Fiber

DANGER  **ALWAYS** wear safety glasses when working with optical fibers. **BE VERY CAREFUL** to dispose of fiber ends properly. The fibers create slivers that easily puncture the skin and cause irritation.

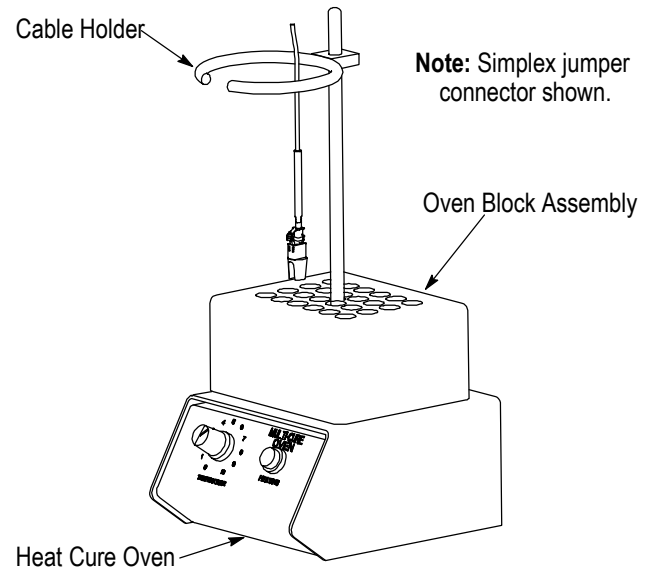



Figure 11

1. If used, carefully rotate the fiber protector to remove it from the connector subassembly.
2. Firmly support the connector assembly.
3. Place the blade of the scribe tool directly above the epoxy or adhesive. **DO NOT** allow the blade to make contact with the epoxy or adhesive. Refer to Figure 12.

CAUTION  Allowing the blade to touch the epoxy or adhesive could damage, chip, or crack the cutting tip of the blade.

4. Lightly draw the beveled edge of the blade across the fiber parallel to the tip of the ferrule. After scoring the fiber, pull it straight away from the ferrule. The fiber should shear cleanly at the scribed point.

3.9. Install the Boot

Slide the boot over the cable until it is against the rear body of the connector subassembly. See Figure 13.

Cleaving the Fiber

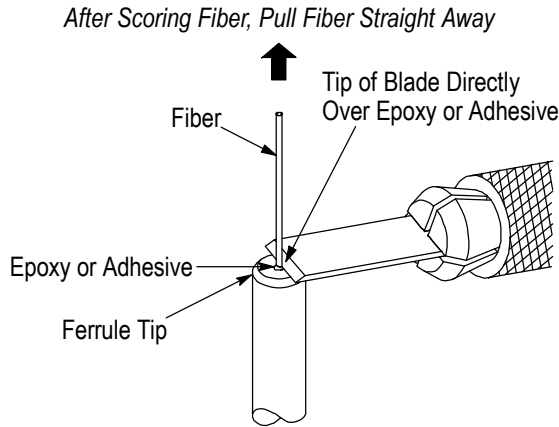

Figure 12

Installing the Boot

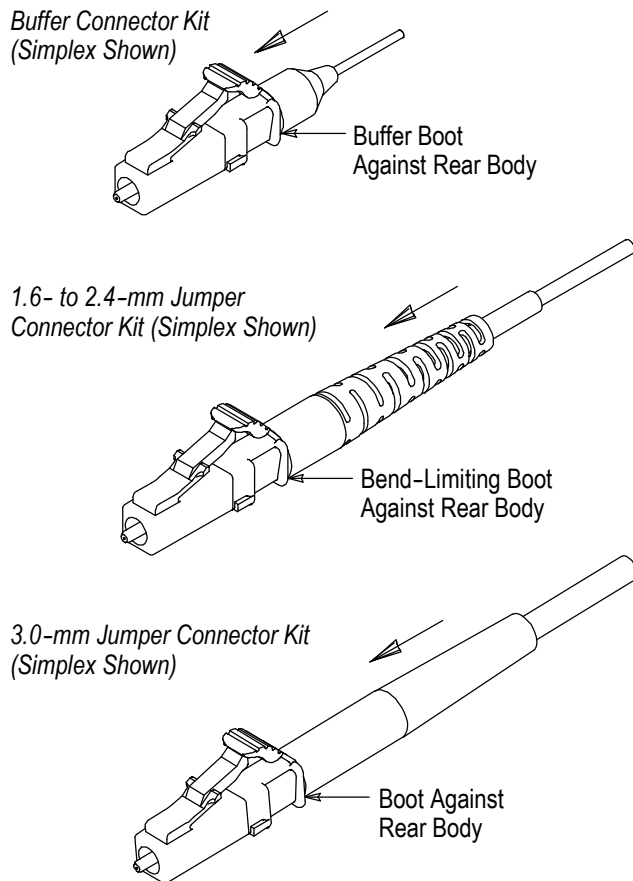

Figure 13

3.10. Polish the Fiber

It is recommended polishing the fiber using a polishing machine. *Machine polishing produces the best results.* Polish the fiber according to the machine manufacturer's instructions.

If machine polishing is not possible, hand polish the fiber according to the following:

NOTE For optimum results, keep the polishing films clean.

i

1. Level the fiber. Using a small piece of the 5- μ m (light grey) polishing film, lightly polish the endface of the ferrule in a small circular motion to remove the fiber stub down to the level of the epoxy or adhesive and until the fiber stops leaving a trace on the film.
2. Install the connector subassembly onto the polishing bushing.
3. Place the polishing pad on the polishing plate. Place the 9- μ m polishing film on the polishing pad.

CAUTION ALWAYS place the polishing bushing on a clean area of the polishing film. NEVER start polishing across a dirty area of the polishing film.

!

4. Holding the polishing bushing and connector subassembly, place the polishing bushing on the film. Using light pressure on the ferrule, polish in an elongated figure-8 pattern (approximately 50.8 mm [2.0 in.] long). Make 15 figure-8 patterns.
5. Clean the endface of the ferrule and the polishing bushing with the alcohol pad or alcohol-dampened lint-free cloth.
6. Remove the 9- μ m polishing film from the polishing pad, and place the fine diamond (green or lavender) polishing film on the polishing pad. Hold the assembly and, using very light pressure, polish the tip of the fiber in an elongated figure-8 pattern (approximately 50.8 mm [2.0 in.] long). Make six figure-8 patterns.
7. Inspect the fiber according to Paragraph 3.11. If small peripheral chips are evident in the fiber, continue polishing the fiber with the fine diamond film. Inspect the fiber again. If the fiber is not acceptable, it might be necessary to use the 9- μ m polishing film, then use the fine diamond polishing film to remove small peripheral chips.

NOTE MAKE SURE to clean the endface of the ferrule and the polishing bushing between film changes.

i

8. Clean the endface of the ferrule and the polishing bushing with the alcohol pad or alcohol-dampened lint-free cloth.
9. Remove the fine diamond polishing film from the polishing pad, and replace it with the 0.3- μ m (white) polishing film.
10. Holding the polishing bushing and connector subassembly, place the polishing bushing on the film, and using light pressure on the ferrule, polish in an elongated figure-8 pattern (approximately 50.8 mm [2.0 in.] long) according to the following:
 - for multimode connectors, make three figure-8 patterns
 - for singlemode connectors, make 12 figure-8 patterns
11. Clean the endface of the ferrule and the polishing bushing with the alcohol pad or alcohol-dampened lint-free cloth.

3.11. Inspecting the Fiber



Before inspecting the fiber, DISCONNECT the fiber from the power signal source. NEVER inspect or look into the end of a fiber when optical power is applied to the fiber. The infrared light used, although it cannot be seen, can cause injury to the eyes.

1. Using the microscope, inspect the endface of the ferrule and fiber according to the following criteria (refer to Figure 14):
 - Make sure that all adhesive or epoxy is removed from the ferrule. Use a sharp blade to remove adhesive or epoxy from the chamfered edge of the ferrule. DO NOT touch the fiber.
 - Dirt may be mistaken for small pits. If dirt is evident, clean with the alcohol pad or alcohol-dampened lint-free cloth, then dry.
 - Fine polishing lines are acceptable.
 - Small peripheral chips at the outer rim of the fiber are acceptable.
 - Large chips in the center of the fiber are unacceptable, and the fiber must be re-terminated.

2. If not installing the connector immediately, install the protective cover onto connector subassembly to prevent contamination to the endface of the ferrule.

STOP!
Don't Connect Unless You Inspect!

3.12. Install Connectors onto Duplex Clip

1. Identify Channel A of the connector and locate Cavity A on the duplex clip.

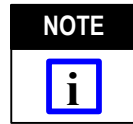

To determine the polarity of a patchcord, light one fiber path. One of the two connectors should be illuminated. Designate the lit channel as Channel A and the other channel as Channel B.

2. Center the rear body of the connector subassembly between the cavity of the duplex clip as shown in Figure 15, Detail A, and using a biasing force, insert the connector into the cavity. Correct placement is denoted by an audible “click.”

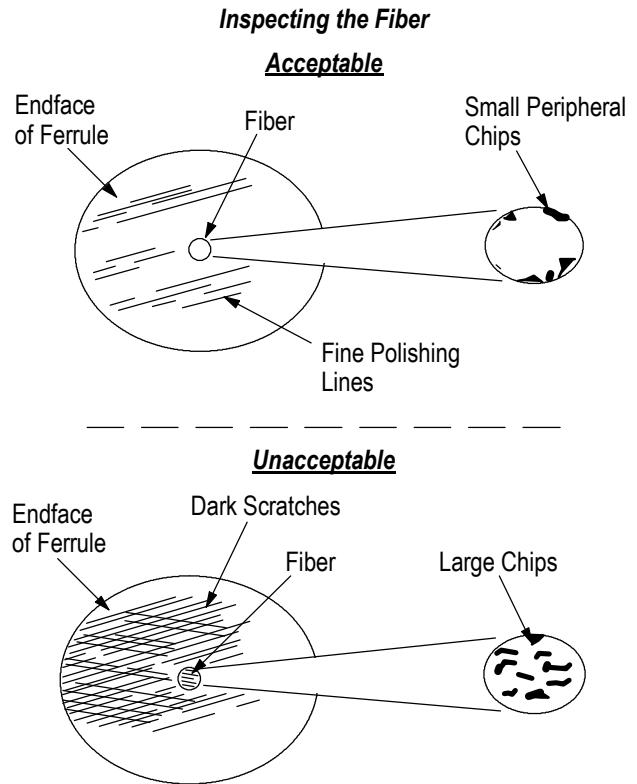
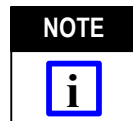

Figure 14



For correct installation, the rib on the duplex clip must align with the recess in the rear body of the connector subassembly. In addition, the arrow on the duplex clip that should point toward the front of the connector subassembly. Refer to Figure 15, Detail A.

3. Identify Channel B of the connector, locate Position B on the duplex clip, and repeat Step 2.

3.13. Removing Connector from Duplex clip.

If necessary (for example, to inspect, to insert into a photo-detector adapter, or to correct a polarity error), remove the duplex clip according to the following:

Hold either a connector (the one that will not be removed) or the duplex clip, grip the connector to be

removed, and gently rotate the connector until it snaps out of the duplex clip. Refer to Figure 16.

Installing Connectors onto Duplex Clip

Detail A

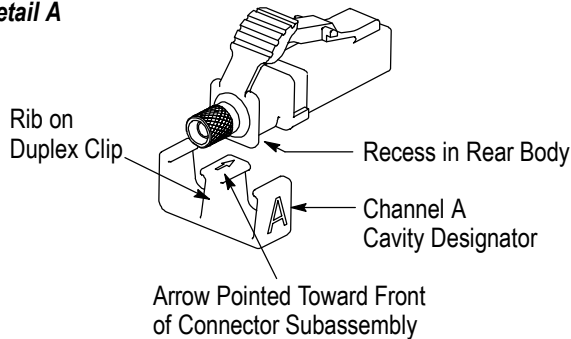

Detail B

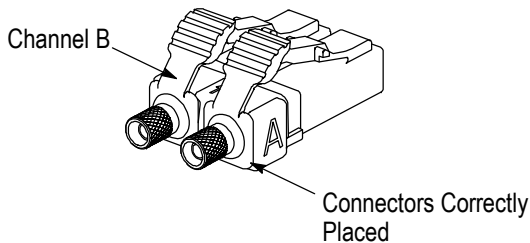
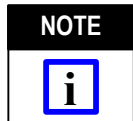

Figure 15



Removing the connector from the duplex clip in this manner should prevent damage to the duplex clip and allow for re-use.

Removing Connector from Duplex Clip

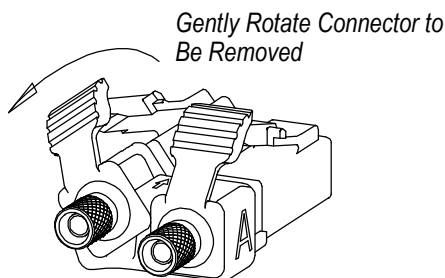
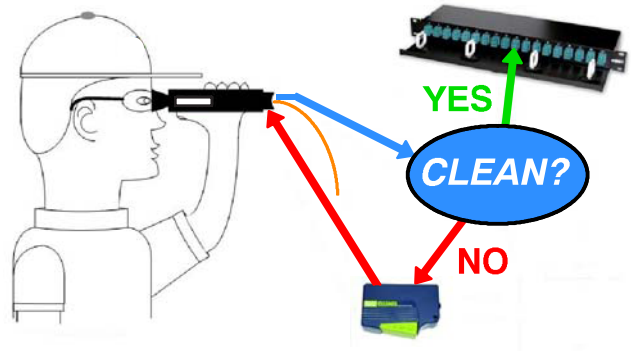

Figure 16

STOP!
Don't Connect Unless You Inspect!



DANGER: Never View Active Fiber Signals

4. CLEANING PROCEDURE

4.1. Connector



To avoid personal injury, compressed air used for cleaning must be reduced to less than 207 kPa [30 psi], and effective chip guarding and personal protective equipment (including eye protection) must be used.

1. Wipe completely around the ferrule with an alcohol pad or lint-free cloth dampened with isopropyl alcohol. Then wipe completely around the ferrule using a dry lint-free cloth.
2. Place the dry lint-free cloth on a smooth, flat surface. Holding the connector perpendicular with the surface, wipe the endface of the ferrule across the cloth.
3. Blow compressed air across the endface of the ferrule.
4. Using the microscope, examine the endface of the ferrule for debris. If debris is present, repeat Steps 1 through 3.



This is the final step prior to connector installation. DO NOT wipe the ferrule or allow it to touch anything before mating the connector.

5. Mate the connector to the receptacle. If the attenuation is too high, unmate both connectors (if applicable), repeat Steps 1 through 4, and clean the receptacle according to Paragraph 5.2.

4.2. Receptacle

1. Blow compressed air through the receptacle.

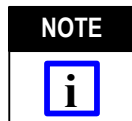

If both connectors are not mated, blow compressed air into the open end of the receptacle.

2. Re-mate the connector(s) to the receptacle, and repeat Paragraph 5.1. If attenuation is still too high, repeat the cleaning procedure (Paragraphs 5.1 and 5.2).

5. REPLACEMENT AND REPAIR

Kit components are not repairable. Replace any damaged components. DO NOT re-use terminated connector subassemblies, crimp eyelet/heat shrink assemblies, or crimp eyelets by removing the cable.

6. REVISION SUMMARY

Revisions to this instruction sheet include:

- Removed table containing part numbers from Figure 1;
- Added "Inspection reminders;"
- Updated the consumables and tools; and
- Updated document to corporate requirements.
- Rebranded to **CommScope**