

# **SYSTIMAX®**

---

## SOLUTIONS

# **Installation Procedures for SC Fiber Optic Connectors**

## **Epoxy and EZ Method (Multimode and Singlemode) Behind-The-Wall (BTW) and Jumper Connector**

**Material ID 860 393 024**

Issue 3  
August 2008

**SYSTIMAX® Structured Connectivity Solutions**

[www.systemax.com](http://www.systemax.com)

# Table of Contents

<b>1. General</b>	<b>1</b>
<b>2. How to Contact Us</b>	<b>2</b>
<b>3. Precautions</b>	<b>2</b>
<b>4. Cable and Fiber Preparation</b>	<b>2</b>
4.1 Coated Fiber	2
4.2 Buffered Fiber Cable (Premises/Building)	3
4.3 Jacketed Fiber Cable (3.0 mm)	4
<b>5. Epoxy Preparation</b>	<b>5</b>
Preparation of Epoxy Furnished in Plastic Container	5
<b>6. Adhesive and Primer Preparation</b>	<b>5</b>
<b>7. Connector Installation</b>	<b>6</b>
7.1 Connector–Buffered Fiber Assembly	6
7.2 Cure the Epoxy	7
7.3 Connector–Jacketed Fiber Cable Assembly (3.0 mm)	7
<b>8. Cleave Fiber and Polish Connector Ends</b>	<b>9</b>
8.1 Cleave the Fiber	9
8.2 Polish Connector Ends	9
8.2.1 Polish Domed-Tipped Connector Ends	10
<b>9. Inspection</b>	<b>11</b>
9.1 Using Microscope to Inspect Fiber	11
9.2 Repairs (Domed Connectors Only)	13
9.3 Snap On Connector Grip	13
<b>10. Ordering Information</b>	<b>13</b>
10.1 Tool Kits	13
10.2 Connectors	14
10.3 Consumable Kits–Do not contain adhesives	14
10.4 Couplings (Standard)	14
10.5 Epoxy	15
10.6 Adhesives	15

# Installation Procedures for SC Fiber Optic Connectors (Multimode and Singlemode)

## 1. General

The 1032H and 1032B5/B6 Tool Kits contain tools to assemble SC Connectors onto building and optical-fiber cables (Figures 1 and 2). Required consumables are sold separately.

The consumables kits for singlemode and multimode connectors are shown in Table 1 below. Each contain polishing paper and other materials required to assemble the connectors. Type F polishing paper is required for all MM connector ferrule repairs. Type F polishing paper is a diamond polishing paper, which is costly and therefore sold in a separate kit so that it can be managed efficiently. Type F paper will remove zirconia ferrule material. This is needed when a glass fiber breaks off below the ferrule surface.

Adhesives required for the EZ installation procedure must be purchased separately. Adhesives can be purchased from **SYSTIMAX**<sup>®</sup> as EZ Adhesives (Material ID 760000810) or adhesives can be purchased from any **Loctite** distributor.

The approved adhesives are as follows:

- 648 Retaining Compound
- 7090 Solventless Primer
- 495 Superbonder

Epoxy is not contained in the consumables kits. Epoxy has a shelf life and must be ordered separately. It is sold separately to allow better material management by separating the epoxy from polishing materials that do not have a shelf life.

See **Section 10.5** and **10.6** for ordering information.

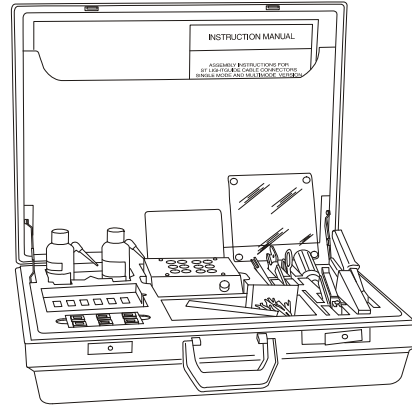


Figure 1. 1032B5/B6 Tool Kit

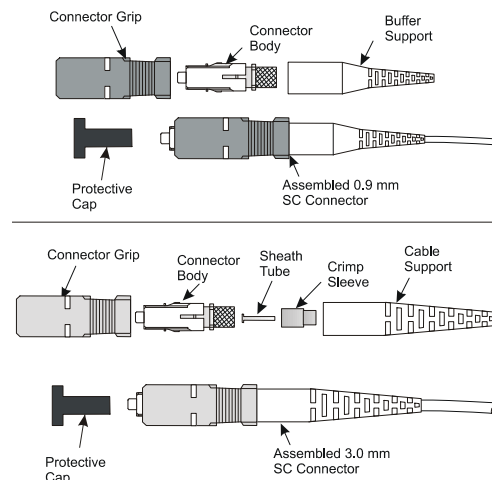


Figure 2. SC Fiber Optic Connectors

### Connector Product Description

Table 1.

Connector Code	Type Mode	Buffer or Jacket Size (mm)	Material ID	Consumable Kit Required <sup>1</sup>	Material ID
P6200B-Z-125	MM	3.0	760007047	Kit-C-UNIV-M-100	760066720
P6201B-Z-125	MM	0.9 <sup>2</sup>	760007070	Kit-C-UNIV-M-100	760066720
P6000B-Z-125	SM	0.9, 3.0	760007096	Kit-C-UNIV-S-100	760066738
P6001B-Z-125	SM	0.9	760007112	Kit-C-UNIV-S-100	760066738

**Notes:** 1. Type F polishing paper is required for repairs, see **Table 6** in **Section 10.3**.

2. When using 250 µm coated fiber, also use D-181755 Consumable Kit

## 2. How to Contact Us

- To find out more about **SYSTIMAX**® Solutions, visit us on the web at <http://www.systimax.com/>
- For technical assistance regarding **SYSTIMAX** products:
  - Within the United States, contact your local account representative or **SYSTIMAX** technical support at 1-800-344-0223. Outside the United States, contact your local account representative or Authorized BusinessPartner.
  - Within the United States, report any missing or damaged parts to **SYSTIMAX** Customer Service in Omaha, NE, at 1-866-539-2795. Outside the United States, contact your local account representative or Authorized BusinessPartner.

## 3. Precautions

- Safety glasses should be worn at all times while performing the installation procedures.
- Avoid skin contact with adhesive.
- When the heater is in operation, place it away from combustibles.
- Disconnected optical connectors may emit radiation if the far end is coupled with a working laser or Light-Emitting Diode (LED). Do not view the fiber end of a cable or plug with an optical instrument until absolute verification is established that the fiber is disconnected from any laser or LED source.
- For cleaning of these fiber optic products, always use fiber optic cleaning solution or Isopropyl Alcohol (>91% 2-Propanol + water).
- It is recommended that you use the E-Series **Ultrajet**® duster when canned air is required.
- As compressed air products have the potential to deposit moisture and propellant debris on critical optical surfaces, CommScope does not recommend the use of any canned air products when cleaning a fiber optic connector surface.

## 4. Cable and Fiber Preparation

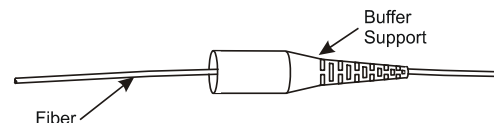
### 4.1 Coated Fiber

**Note:** Use the appropriate procedures for preparing outside plant (OSP) cable. See instruction sheet **636-**

**299-110-5** for more information on grounding, blocking, and buffering fiber optic cable.

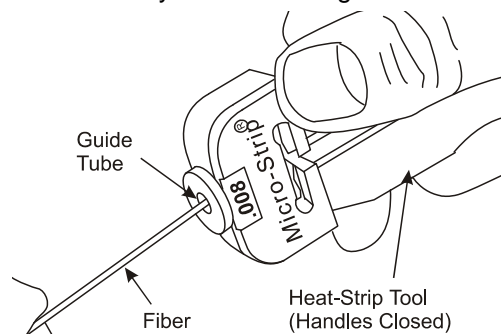
**Important:** Do not attempt to remove the fiber coating until a buffer tube has been placed over the coated fiber. This will prevent cutting the fiber by mistake.

1. **Expose an Appropriate Length of Coated Fiber** (as specified in the D-181755 Kit) to allow for connector installation and termination.
2. **Place an Appropriate Length of Buffered Tubing** from the D-181755 Kit over the fiber to be stripped.
3. **Place Buffer Support onto Fiber** Slip the buffer support onto the buffer tube covering the fiber (Figure 3).

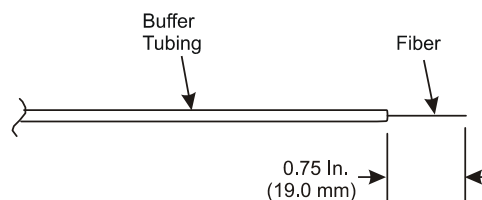


**Figure 3. Install Buffer Support on Buffer Tubing**

4. **Remove Fiber Coating**—With the stripper handles open and the buffered tube aligned with the end of the fiber, insert both fiber and buffer tubing through the guide tube opening enough to allow about 0.75 inch (19 mm) of buffer and fiber coating to be removed (Figure 4 and Figure 5). Close the handles and pull the buffer away from the tool with a smooth motion. Wipe the stripped fiber with a wipe dampened with isopropyl alcohol to remove any residual coating.



**Figure 4. Heat-Strip Tool—Remove Fiber Coating from Buffered Fiber**



\* Registered trademark of Chemtronics, Inc.

**Figure 5. Recommended Strip Dimensions for Singlemode and Multimode Connectors**

5. **Install Connector on Fiber**—Use the procedures outlined in **Section 7.1 Connector—Buffered Fiber Assembly** in this manual to complete installation of the connector, cure the adhesive, polish and inspect the fiber end.

#### 4.2 Buffered Fiber Cable (Premises/Building)

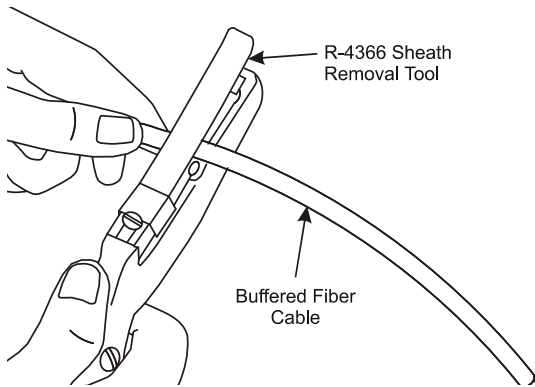
1. **Remove Outer Jacket**—Using the R-4366 sheath removal tool, ring-cut the outer sheath the required distance from the cable end and remove outer jacket (Figure 6). Typical length is approximately 24 to 36 inches (0.6 to 0.9 meters).

**Important: Do not cut into fibers.**

**Note:** The exposed buffered fiber should be long enough to:

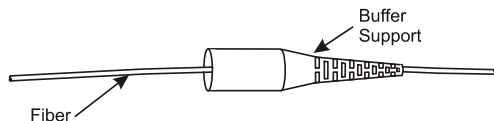
- Allow for placement into the equipment cabinet.
- Allow access during the polishing process
- Prevent stress on the fiber during connector application.

**Note:** See Table 1 on page 1 to verify correct connector choice for cable type.



**Figure 6. R-4366 Sheath Removal Tool—Ring-Cut Cable Jacket**

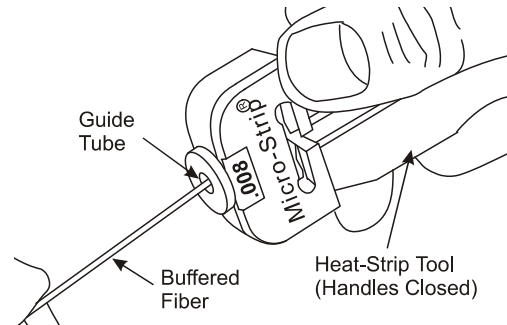
2. **Place Buffer Support onto Cable**—Slip the buffer support onto the buffered fiber (Figure 7).



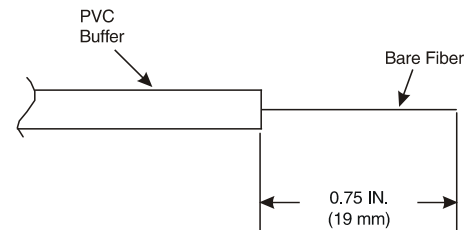
**Figure 7. Install Buffer Support on Buffered Fiber**

3. Measure and Mark the Buffered Fiber 0.75 inch (19 mm) from the end.

4. **Remove Buffer and Fiber Coating**—Refer to 1026A heat-strip tool operating instructions for setup. Make sure heater unit is fully inserted. Insert buffered fiber through the guide tube to allow 0.75 inch (19 mm) of the buffer and coating to be removed (Figure 8 and Figure 9). Close the handles and wait 6 to 10 seconds for softening of the buffer to occur. Pull the fiber from the tool with one smooth motion. Wipe the stripped fiber once with a wipe dampened with isopropyl alcohol to remove any residual coating.

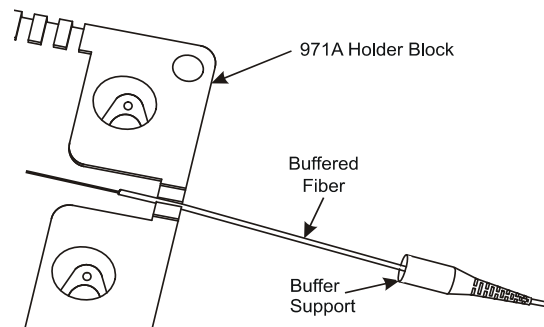


**Figure 8. Heat-Strip Tool—Remove Fiber Coating from Buffered Fiber**



**Figure 9. Buffered Fiber Stripping Dimensions**

5. **Set Aside the Prepared Fibers**—Place the prepared fiber into the grooves of the 971A holder block as shown in Figure 10 (provided with the tool kits).



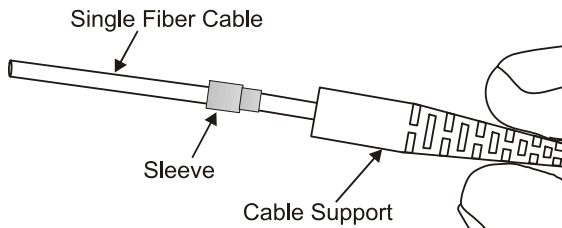
**Figure 10. 971A Holder Block with Buffered Fiber**

6. **Install Connector on Fiber**—Use the procedures outlined in **Section 7.1 Connector—Buffered**

**Fiber Assembly** to complete the installation of the connectors, cure the adhesive, polish and inspect the fiber end.

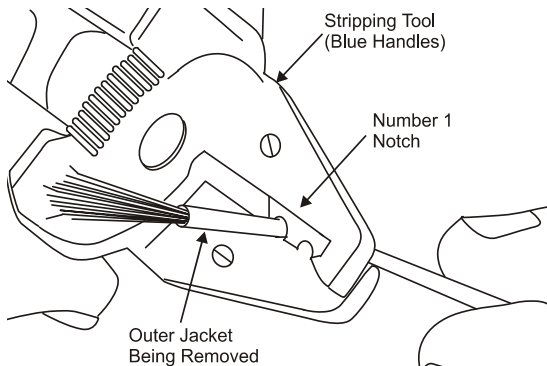
### 4.3 Jacketed Fiber Cable (3.0 mm)

1. **Place Cable Support and Crimp Sleeve onto Cable**—Slip the cable support and the crimp sleeve onto the cable (Figure 11).



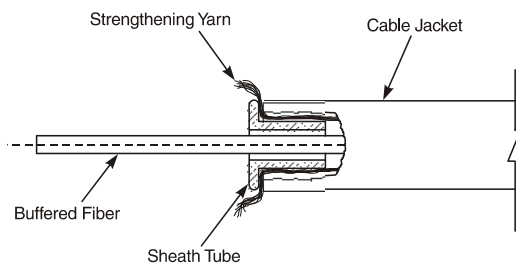
**Figure 11. Cable Support and Sleeve on Single Fiber Cable**

2. **Measure and Mark Cable**—Using either a scale or template, measure and mark the cable 1.35 inches (34 mm) from the end of the cable.
3. **Remove Outer Jacket**—Using the Number 1 notch on the blue-handled 700A stripping tool, remove the outer jacket back to the mark (Figure 12).



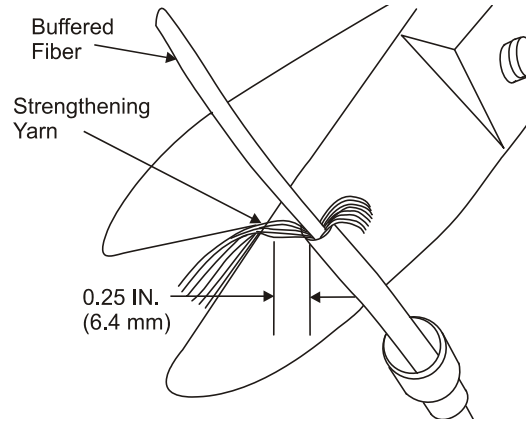
**Figure 12. Strip Outer Jacket of Single Fiber Cable**

4. **Insert Sheath Tube into Cable Jacket**—For 3.0 mm cable, insert the sheath tube over the buffered fiber and into the cable jacket (Figure 13).



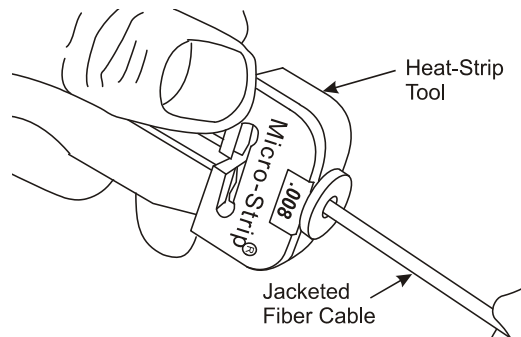
**Figure 13. Sheath Tube Insertion for 3.0 mm Cable**

5. **Cut Strengthening Yarn**—With the strengthening yarn separated into two equal size bundles, use scissors to trim the strands 0.25 inch (6 mm) from the edge of the outer jacket (Figure 14). Flair the strengthening yarn evenly all around the cable.



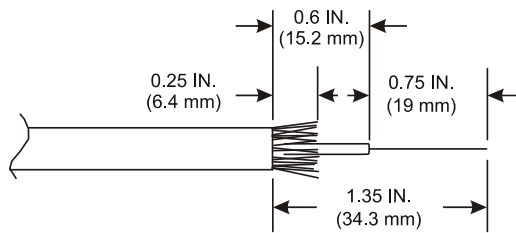
**Figure 14. Cut Strengthening Yarn—Single Fiber Cable**

6. **Measure and Mark Buffered Fiber**—Measure and mark the buffered fiber 0.75 inch (19 mm) from the end of the buffered fiber.
7. **Remove Buffer and Fiber Coating**—Refer to 1026A heat-strip tool operating instructions for setup. Make sure heater unit is fully inserted. Insert buffered fiber through the guide tube to allow 0.75 inch (19 mm) of the buffer and coating to be removed. Close the handles and wait 6 to 10 seconds for softening of the buffer to occur. Pull the fiber from the tool with one smooth motion (Figure 15). Wipe the stripped fiber with a wipe dampened with isopropyl alcohol to remove any residual coating.



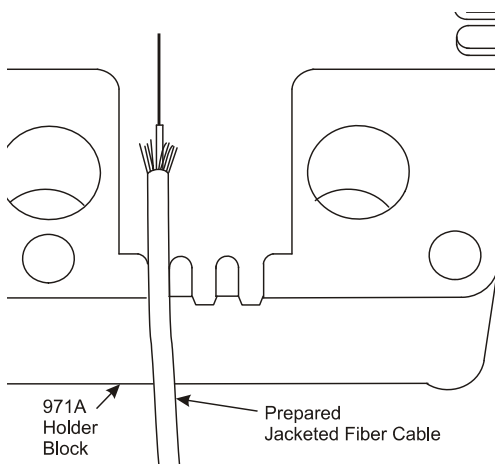
**Figure 15. Heat-Strip Tool—Jacketed Fiber Cable**

**Recommended Dimensions**—The recommended dimensions for the prepared cable and fiber are shown in Figure 16.



**Figure 16. Recommended Dimensions for 3.0 mm Cable**

8. **Set Aside Prepared Cable**—Place the prepared cable into the grooves of the 971A holder block provided with the tool kit (Figure 17).



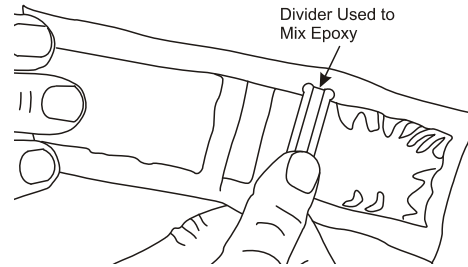
**Figure 17. 971A Holder Block with Jacketed Fiber Cable**

9. **Install Connector on Fiber**—Use the procedures outlined in

## 5. Epoxy Preparation

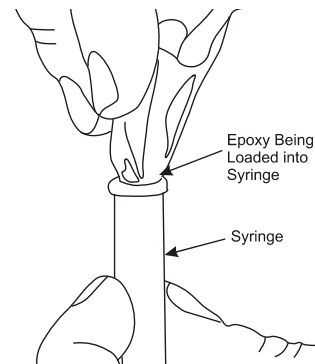
### Preparation of Epoxy Furnished in Plastic Container

1. **Remove Epoxy Divider**—This is a two-part epoxy separated with a divider. The divider must be removed to allow the epoxy to be mixed.
2. **Mix the Epoxy**—Using the divider, thoroughly mix the epoxy until both parts are blended into a smooth, uniform color (Figure 18).



**Figure 18. Mix the Epoxy**

3. **Install Syringe Tip**—Place the syringe tip onto the syringe and twist to lock it in place. Then remove the plunger to allow the mixed epoxy to be loaded into the syringe.
4. **Place Epoxy into Syringe**—Fold the epoxy package in half, cut the corner of the package, and squeeze the mixed epoxy into the syringe (Figure 19). Replace the plunger in the syringe. A 3/4-inch length (19 mm) of epoxy will be enough for about 12 connectors.



**Figure 19. Place Epoxy into Syringe**

5. **Remove Air From Syringe**—Remove air pockets from the syringe by holding the syringe tip upward and ejecting epoxy until the air pockets are removed.

## 6. Adhesive and Primer Preparation

For the EZ installation method use the following **Loctite<sup>†</sup>** products;

- 648 Retaining Compound
- 7090 Solventless Primer
- 495 Superbonder

Adhesives may be purchased directly from **SYSTEMAX** Solutions using Material ID 760000810 EZ

<sup>†</sup> Loctite is a registered trademark of Loctite Corp.

**860 393 024**  
**Instruction Sheet**

Adhesive. They may also be purchased directly from a **Loctite** distributor.

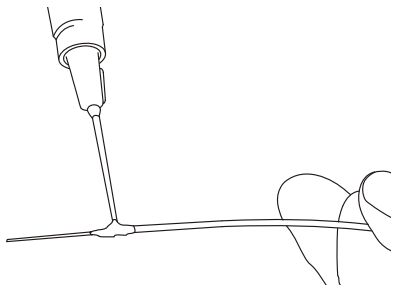
1. **Prepare adhesive**—Shake the bottle of adhesive vigorously. Remove the cap from the bottle of adhesive. If the adhesive has not been opened, use a straight pin to make a hole in tip of nozzle.
2. Remove plunger and cap from a syringe and load adhesive into the syringe. Replace plunger and twist a syringe tip into place. (As a second option, simply twist a syringe tip onto nozzle of adhesive bottle making sure that tip fits snugly.)
3. **Prepare primer**—Shake the bottle of primer vigorously. Place a syringe tip onto a 3-cc syringe and twist to lock it in place. Remove the top from the bottle of primer and draw 0.5-cc of primer into the syringe. Alternatively, simply twist a syringe tip onto the nozzle of the bottle of primer.

**Note:** Once the installation procedure has been completed, any extra primer in the syringe may be returned to the original bottle. However, the syringe tip should be removed to avoid getting adhesive, which may be on tip, mixed in with primer.

## 7. Connector Installation

### 7.1 Connector—Buffered Fiber Assembly

1. **Apply the Primer to Fiber Buffer**—Using the syringe with the primer in it, apply primer to 0.25 inch (6 mm) of the buffer (Figure 20). Avoid getting the primer on the fiber. If several connectors are being terminated, it is recommended that all of the buffers be primed before moving on to the next step.

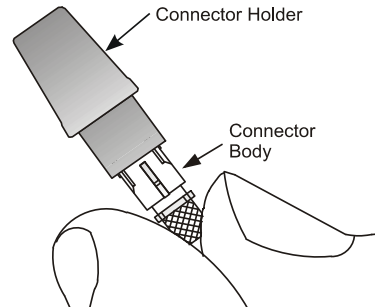


**Figure 20. Apply Primer to Buffer**

2. **Prepare Connector Tip**—Make sure that the hole in the connector tip is clear of any foreign matter. Use music wire to clear the hole if necessary. Place a wipe on the worktable. Using the syringe, place a drop of primer on the wipe. Wipe the end

of the connector through the primer on the wipe one time.

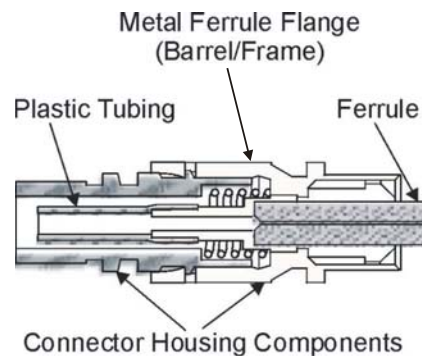
3. **Install Connector Holder**—Place the connector body in a 1510C connector holder (Figure 21).



**Figure 21. Install Connector Holder**

4. **Inject Adhesive into Connector**—Gently insert the syringe tip on the adhesive through the tubing in the back of the connector body until it bottoms against the ferrule. Inject the adhesive into the ferrule until a bead of adhesive forms on the tip of the ferrule (Figure 22). The adhesive bead should cover at least one-half of the ferrule end face. Withdraw the syringe tip from the connector body, but maintain slight pressure on the bottle or syringe to coat the inside diameter of the metal ferrule flange (barrel) with the adhesive.

**Important:** Do not fill the plastic tubing with adhesive. Do not allow the adhesive to get onto the connector housing components.



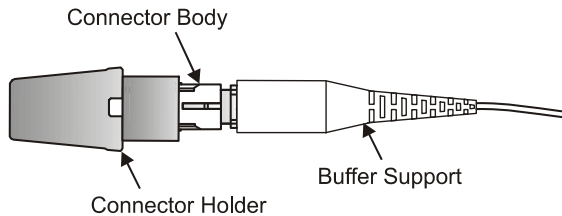
**Figure 22. SC Connector Components**

5. **Insert Fiber into Connector Body**—Immediately insert the fiber through the connector body, carefully feeling for the ferrule capillary. Rotate the connector body as the fiber is inserted to allow the fiber to pass through the connector body without hanging up. Seat the fiber into the connector body making sure the buffer is completely seated against the ceramic inside the connector body.



6. **Install Buffer Support**—Apply a drop of **Loctite Super Bonder 495** to the large and small grooves at the back of the connector body. Slip the buffer support onto the connector body (Figure 23). Make sure that the fiber is fully seated into the connector body.

**Important: Use only the connector or buffer support when handling the connector assembly. Make sure that the buffered fiber is fully inserted into the connector body and is not disturbed until adhesive has cured.**



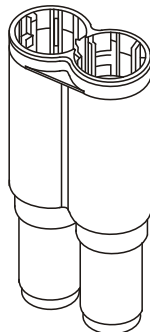
**Figure 23. Install Buffer Support**

7. **Allow Adhesive to Cure**—Place the assembly in the 971A holder block. Allow the adhesive to cure at least 1 minute.

## 7.2 Cure the Epoxy

1. **Set-up the Curing Oven**—Place the oven away from combustibles, and connect the power cord to a power source (**120 V 60 Hz AC for the 200A oven and 220 V 50 Hz AC for the 200A1 international oven**). To apply power, push the ON/OFF switch to the ON position. The switch will illuminate, indicating that the power is on. In about 5 minutes, an illuminated READY lamp indicates that the oven is ready for use.

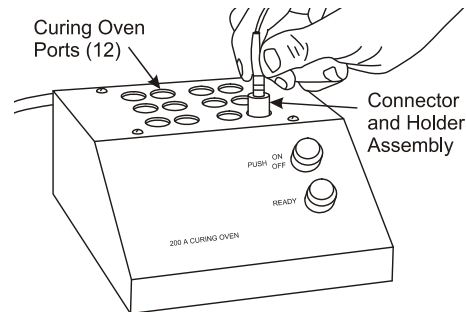
**Important: If terminating 1.6 mm cordage, place the Heat Tube Assembly Fixtures into the ports of the oven (Figure 24).**



**Figure 24. Heat Tube Assembly**

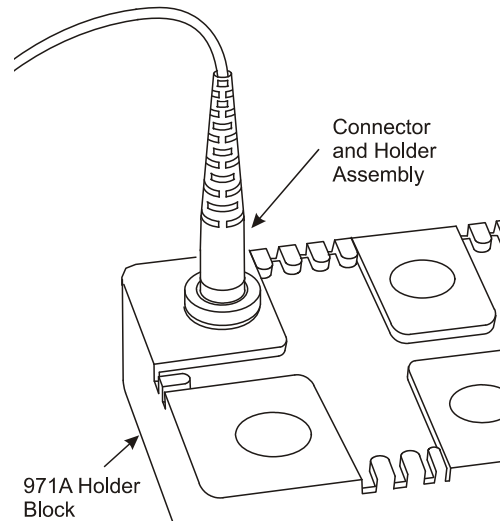
2. **Place Connector into Oven**—Place the connector and holder assembly into one of the oven ports (Figure 25). Cure for 10 minutes. Connectors on

1.6 mm cordage will be inserted into the Heat Tube Assembly Fixtures.



**Figure 25. Place Connector into Oven**

3. **Place Connector into 971A Holder Block**—After 10 minutes of curing time, remove the connector and holder assembly from the oven and place it into one of the ports in the 971A holder block to cool (Figure 26).

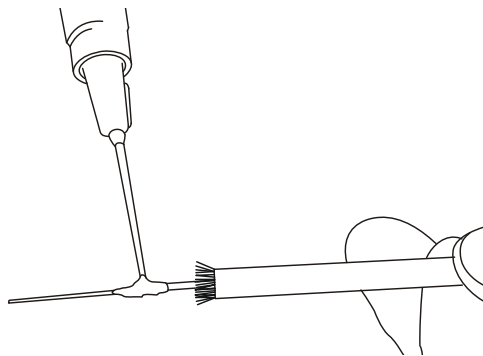


**Figure 26. Place Connector and Holder Assembly into 971A Holder Block**

4. **Install Cable Support** – For 1.6 mm cable, snap the cable onto the connector body.

## 7.3 Connector–Jacketed Fiber Cable Assembly (3.0 mm)

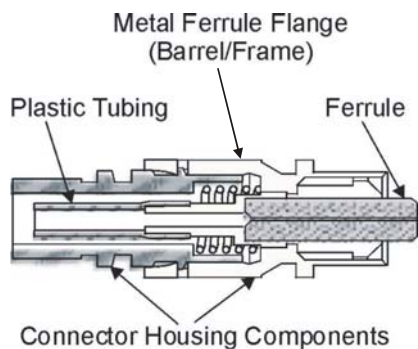
1. **Apply Primer to Fiber Buffer**—Using the syringe with the primer in it, apply primer to 0.25 inch of the buffer (Figure 27). Avoid getting the primer on the fiber. If several connectors are being terminated, it is recommended that all of the buffers be primed before moving on to the next step.



**Figure 27. Apply Primer to Buffer**

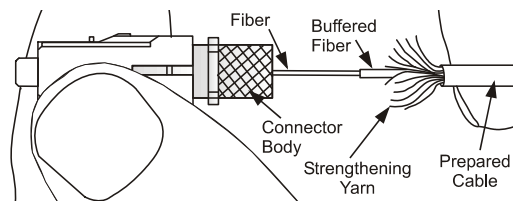
2. **Prepare Connector Tip**—Make sure that the hole in the connector tip is clear of any foreign matter. Use music wire to clear the hole if necessary. Place a wipe on the worktable. Using the syringe, place a drop of primer on the wipe. Wipe the end of the connector through the primer on the wipe one time.
3. **Install Connector Holder**—Place the connector body in a 1510C connector holder.
4. **Inject Adhesive into Connector Body**—Gently insert the syringe tip on the adhesive through the tubing in the back of the connector body until it bottoms against the ferrule. Inject the adhesive into the ferrule until a bead of adhesive forms on the tip of the ferrule (Figure 28). The adhesive bead should cover at least one-half of the ferrule end face. Withdraw the syringe tip from the connector body, but maintain slight pressure on the bottle or syringe to coat the inside diameter of the metal ferrule flange (barrel) with the adhesive.

**Important: Do not fill the plastic tubing with adhesive. Do not allow the adhesive to get onto the connector housing components.**



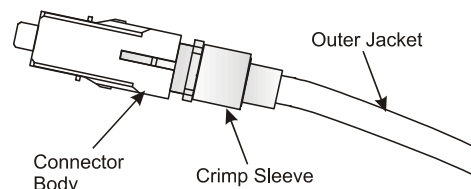
**Figure 28. SC Connector Components**

5. **Insert Fiber into Connector Body**—Immediately insert the fiber through the connector body, carefully feeling for the ferrule capillary. Rotate the connector body as the fiber is inserted to allow the fiber to pass through the connector body without hanging up (Figure 29). Be careful not to break the fiber.



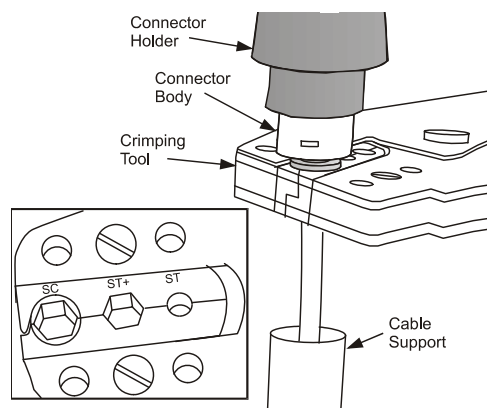
**Figure 29. Insert Fiber into Connector Body**

6. **Install Cable Sleeve**—Slip the cable (crimp) sleeve over the outer jacket and the connector body to capture the yarn between the body and sleeve (Figure 30).



**Figure 30. Install Crimp Sleeve**

7. **Secure Crimp Sleeve**—For 3.0 mm cable, before crimping, make sure the sleeve is fully seated on the cable retention member. Align the crimp sleeve with the SC cavity of the 1510B crimping tool and squeeze the tool handles until they release (Figure 31).



**Figure 31. Crimp Cable Sleeve**

8. **Install Cable Support**—Push the cable support over the crimp sleeve and onto the connector body (Figure 32).

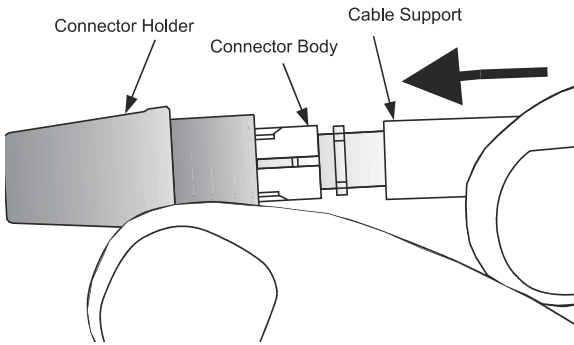


Figure 32. Install Cable Support

9. **Allow Adhesive to Cure**—Place assembly in a 971A holder block (Figure 26). Allow adhesive to cure for at least 1 minute.

## 8. Cleave Fiber and Polish Connector Ends

### 8.1 Cleave the Fiber

1. **Score the Fiber**—Remove the 1510C holder from the connector body. Using one stroke with the cleaving tool, score the fiber close to the crest of the adhesive bead (Figure 33). Scissors may be used as an optional method of removing the excess fiber.

**Note:** A clean, short score significantly improves the success rate. **Do not break the fiber.**

2. Using a **gentle straight pull**, remove the exposed fiber. If the fiber does not pull off with a gentle pull, rescore on the opposite side of the fiber.

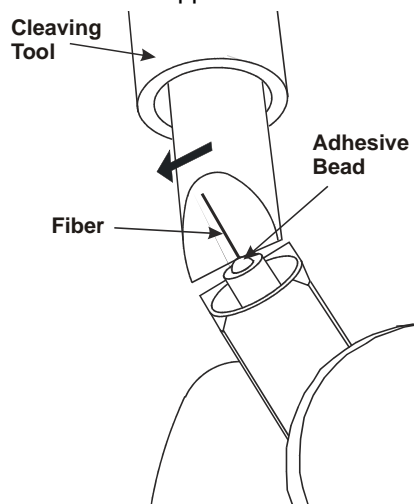


Figure 33. Score the Fiber

### 8.2 Polish Connector Ends

1. **Prepare Polishing Material**—Before positioning the polishing material, clean the bare polishing plate and the back of the non-foam-backed polishing paper with a wipe dampened with isopropyl alcohol. Blow the plate and paper dry with canned air.  
**Important:** Foreign material can cause scratches on the end face of the ferrule if the polishing plate or paper is not properly cleaned.
2. **Prepare Polishing Tool**—Clean the surface of the 1510A polishing tool and the connector tip with a wipe dampened with alcohol.
3. **Air Polish the Cleaved Fiber**—Hold the type H polishing paper, dull side against the connector. Point the connector ferrule upward and, using light circular or figure-8 strokes, polish the cleaved fiber down flush with the adhesive bead.  
**Note:** This will reduce the risk of breaking the fiber during the first polishing.
4. **Insert Connector into Polishing Tool**—Insert the connector tip into the 1510A polishing tool (Figure 34).

*Refer to the polishing guide (Table 2) and the detailed instructions in the following sections.*

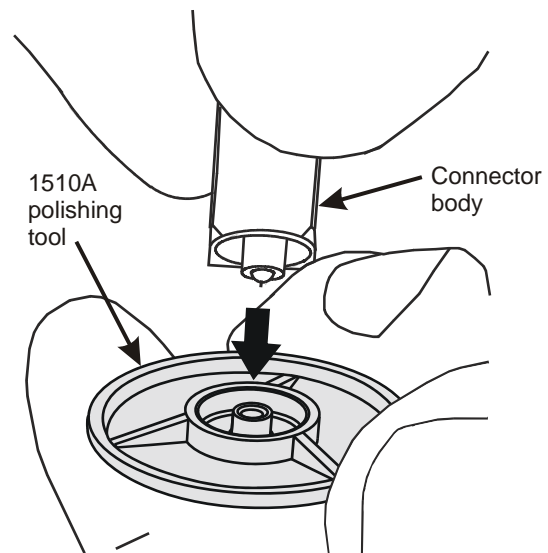


Figure 34. Prepare Polishing Tool

## SC Connector Polishing Guide

Table 2.

Product Code	1 <sup>st</sup> Polish		2 <sup>nd</sup> Polish	Repairs	
	P6200 P6201	P6000 P6001	P6000 P6001	P6200 P6201	P6000 P6001
Ferrule Type (Zirconia)	MM	SM	SM	MM	SM
End Face Geometry	Domed	Domed	Domed	Domed	Domed
Pad Type	None	None	H	Type H paper	Type H paper
Paper Type	H	H	E over H	F over type H	F over type H
Polishing Solution	None	None	Distilled water	Distilled water	Distilled water
Polishing Time or Number of Strokes	Remove all adhesive	Remove all adhesive	8 strokes	Until flaw is removed (40 strokes max)	Until flaw is removed (40 strokes max), then E over type H pad, 8 strokes

### 8.2.1 Polish Domed-Tipped Connector Ends

#### 1<sup>st</sup> Polish – Singlemode and Multimode Connector

1. Place a sheet of type H (green) polishing paper over the plate.
2. Carefully place the connector ferrule into the polishing tool. Starting with **extremely light pressure**, polish the connector on the type H paper using figure-8 strokes until all adhesive has been removed (Figure 35). Check periodically with the eye loupe or magnifier to verify that all of the adhesive has been removed. **No further polishing is required for multimode connectors.**

**Note:** **Extremely light pressure** should be used during the first few polishing strokes to avoid breaking the fiber.

3. Start with a fresh area of the polishing paper for each connector to be polished.

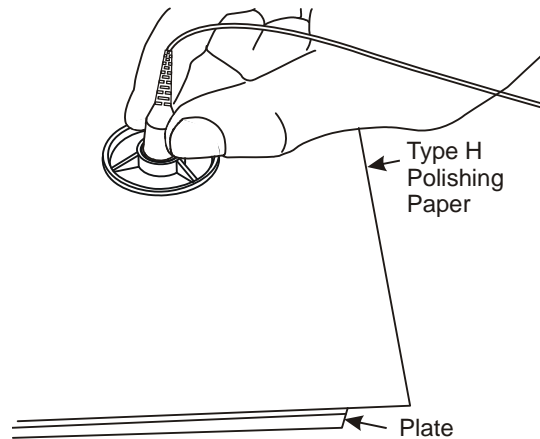


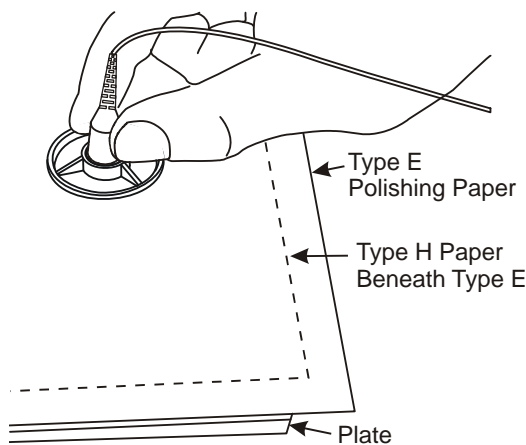
Figure 35. Polish Domed-Tipped Connectors (Type H Paper)

4. Remove the connector from the polishing tool and clean both the connector and the tool with a wipe dampened with isopropyl alcohol. Then use canned air to dry the connector and the tool. Once cleaned, replace the connector into the tool.

## **2nd Polish – Singlemode Connector**

1. To achieve optimum return loss, place the type E paper over a sheet of type H (green) polishing paper (glossy side down).
2. Add a small amount of water to the portion of the paper that will be the working area. Using the polishing tool, work the water into the polishing paper.
3. Place the connector ferrule into the polishing tool and polish the connector ferrule for 6 to 8 strokes; each stroke should be approximately 2 inches (51 mm) in height (Figure 36).

**WARNING: DO NOT exceed 15 strokes.**



**Figure 36. Polish Domed-Tipped Connectors  
(type E over type H)**

## **9. Inspection**

### **9.1 Using Microscope to Inspect Fiber**

1. Attach Connector to Microscope—See **Section 3. Precautions** on page 2. Insert the connector tip into the bottom of the microscope. Open the microscope barrels to illuminate the connector tip, and use the side wheel to focus. A high-intensity light may be used at the other end of the fiber to illuminate the core area.

**CAUTION:** Do not use a laser or LED to illuminate the core area for viewing. The core may not necessarily illuminate if an adhesive film or bead still exists on the connector end face.

2. **Inspect Fiber End**—An acceptable fiber end is free of cracks. Voids or scratches must be avoided in the core area (Figure 37). If the fiber is unacceptable, this fiber end must be reterminated.
3. If the connector is not to be used immediately, cover the end with the protective cap.

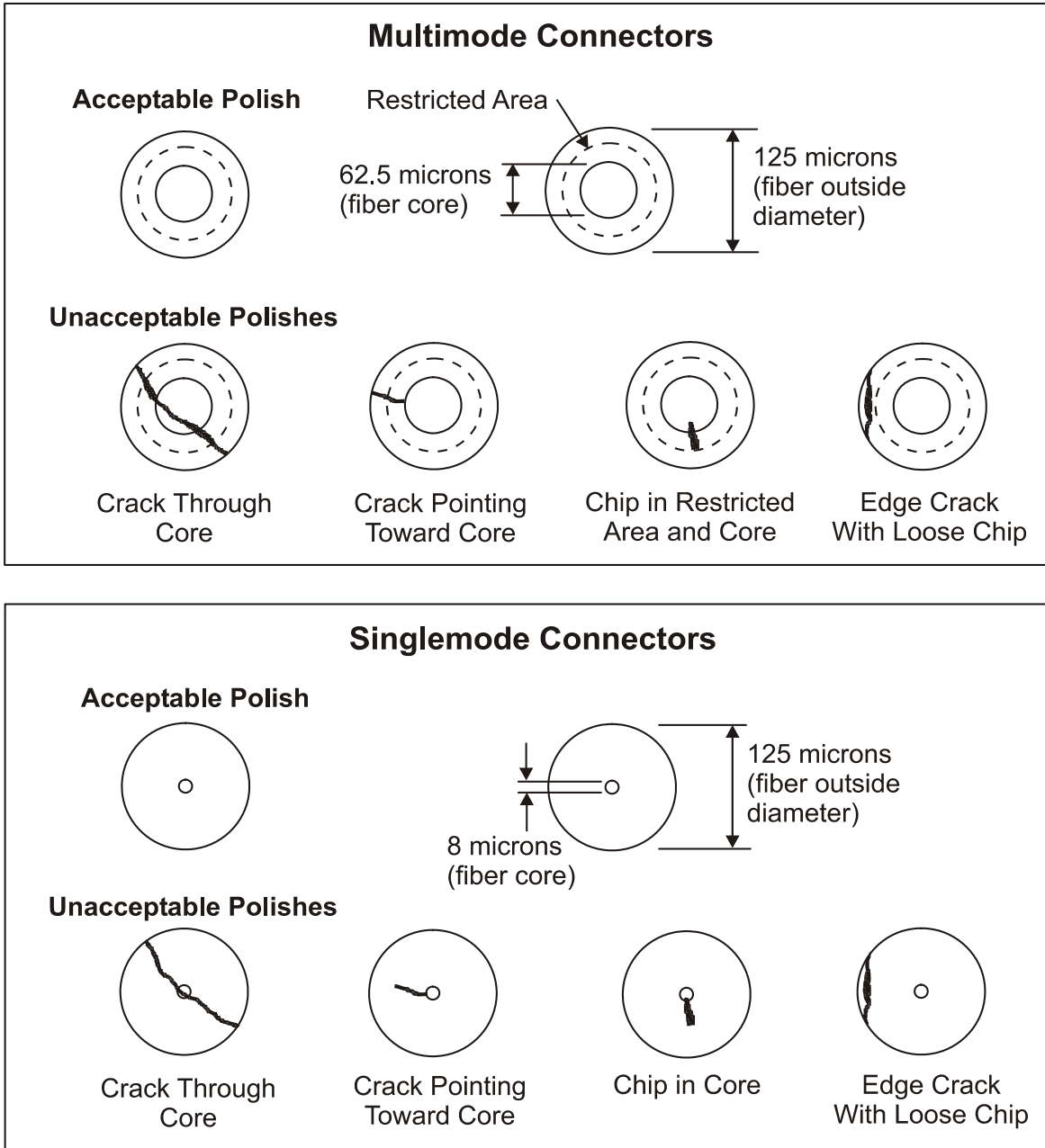


Figure 37 End Face Inspection for Connectors

## 9.2 Repairs (Domed Connectors Only)

When the fiber is cracked or scratched in or near the core, the ferrule in some instances can be repaired.

1. Place type F paper over the type H paper. Type F polishing paper is available by ordering Material ID 700006695. Add a small amount of water to the portion of the paper that will be the working area. Polish the connector for 20-40 strokes or until the flaw has been removed. **No further polishing is required for multimode connectors.**
2. For singlemode connectors, once the flaw has been removed, repeat the **2nd polish** described in **Section 8.2.1 for Singlemode Dome-Tipped Connectors.**

## 9.3 Snap On Connector Grip

1. Snap the connector grip onto the polished assembly and cover the end of the connector with the protective cap. This completes the procedure.

# 10. Ordering Information

## 10.1 Tool Kits

### 1032B5 Tool Kit (Material ID 700 006 026)

Contains the following tools and materials for assembly of SC fiber optic connectors.

**Table 3.**

Kit Qty	Description
1	1510B Crimping Tool
1	300B Microscope
1	1510A or 1510A1 Polishing Tool
12	600B Connector Holders
1	700A Stripping Tool
1	1026A Heat-Strip Tool
2	971A-1 Holder Block
1	975A Cleaving Tool
1	Scissors
1	Alcohol Bottle
1	Clear Acrylic Plate
1	Sheath Removal Tool (R-4366)
1	Instruction Manual
15	Micro Clips (1043A)
1	200A Curing Oven
12	1510C SC Connector Holders
2	Modified SM/MM SC Grips
1	Rubber Polishing Pad
1	1039A Cut-Length Template
1	1039B Cut-Length Template
1	7X Magnifier

### 1032B6 Tool Kit (Material ID 700 005 960)

The 1032B6 Tool Kit is the same as the 1032B5 Tool Kit except the 200A curing oven is replaced by the 200A1 curing oven for use internationally. The 200A1 oven operates on 220 V 50 Hz.

### 1032H Tool Kit (Material ID 700005838)

**860 393 024**  
**Instruction Sheet**

Contains the following tools and materials for assembly of SC Fiber Optic Connectors.

**Table 4.**

<b>Kit Quantity</b>	<b>Description</b>	<b>Kit Quantity</b>	<b>Description</b>
1	300B Microscope	1	Sheath Removal Tool (R-4366)
1	1510A Polishing Tool	1	Instruction Manual
12	600B1 Connector Holders	15	Micro Clips (1043A)
1	700A Stripping Tool	12	1510C SC Connector Holders
1	5B5-Strip Tool	2	Modified SM/MM SC Grips
1	975A Cleaving Tool	1	1039A Cut-Length Template
1	Scissors	1	1039B Cut-Length Template
1	Alcohol Bottle	1	7X Magnifier
1	Acrylic Plate		

## 10.2 Connectors

**Table 5.**

<b>Connector Code</b>	<b>Fiber Type</b>	<b>Buffer/Jacket Size</b>	<b>Material ID</b>
P6200B-Z-125	MM	1.6 mm, 3.0 mm	760007047
P6201B-Z-125	MM	0.9 mm	760007070
P6000B-Z-125	SM	1.6 mm, 3.0 mm	760007096
P6001B-Z-125	SM	0.9 mm	760007112

## 10.3 Consumable Kits—Do not contain adhesives

**Table 6.**

<b>Description</b>	<b>Product Code</b>	<b>Material ID</b>
Multimode <b>ST</b> <sup>‡</sup> II, SC EZ installation	Kit-C-UNIV-M-100	760006720
Multimode <b>ST</b> II, SC Repair	F Polishing Paper	700006695
Singlemode <b>ST</b> II, SC EZ installation	Kit-C-UNIV-S-100	760066738

**D-181755 Kit (Material ID 700006117)**—Contains the parts required to make a transition from ribbon or **LIGHTPACK**<sup>§</sup> bundle to individually buffered fibers.

## 10.4 Couplings (Standard)

**Table 7.**

<b>Coupling Code</b>	<b>Material ID</b>	<b>Fiber Type</b>	<b>Coupling Type</b>	<b>Color</b>	<b>Description</b>
C6000A-4	700004807	MM/SM	Simplex	Blue	Snap-in coupling
C6061A-4	700004880	MM	Duplex	Beige	Snap-in coupling
C6060A-4	700004815	MM/SM	Duplex	Blue	Snap-in coupling

<sup>‡</sup> ST is a registered trademark of OFS

<sup>§</sup> LIGHTPACK is a registered trademark of OFS.



## 10.5 Epoxy

The approved epoxies for use with the **SYSTIMAX** epoxy field installations can be obtained from the following distributors;

### Product: EPO-TEK 353ND

#### USA

#### **Epoxy Technologies, Inc.**

14 Fortune Drive  
Billerica, MA 01821  
Tel. 1-800-227-2201

#### Asia, (Japan)

#### **Daizo Corporation**

Tel. 81-3-3246-2251  
Fax 81-3-3246-2271

#### Europe, (France)

#### **Poltec PI, S.A.**

Tel. 33 1 48 10 39 30  
Fax 33 1 48 10 08 03

### Product: Tra-Bond F123MV

#### USA

#### **Tra-Con, Inc.**

45 Wiggans Avenue  
Bedford, MA 01730  
Tel. 1-800-872-2661

#### Asia, (Singapore)

#### **Tra-Con Singapore**

Tel. 65-29-93-071

## 10.6 Adhesives

For the EZ installation procedures, the following adhesives are required:

- 648 Retaining Compound (10 ml) #21443
- 7090 Solventless Primer (1 oz. Bottle) # 19368
- 495 Superbonder (3 gram tube) #49504 (required on 0.9 mm installations)

The approved adhesives can be obtained from **SYSTIMAX** Solutions or any **Loctite** Distributor. To order from **SYSTIMAX** Solutions, request Material ID 760000810 EZ Adhesives. To find the **Loctite** Distributor nearest you either:

Visit their website at [www.loctite.com](http://www.loctite.com)

OR

Call 1-800-323-5106