

# HMT-BCM2A0500NN000



NOVUX™ Hardened Multi-fiber Terminal, 12 HMFOC ports, 2 fibers per port, Dielectric flat loose tube cable, 500 ft/152 m

- NOVUX™ Hardened Multi-fiber Terminals incorporate hardened connector technology that is designed to withstand the rugged outside plant environment
- Hardened connectors are factory-integrated and environmentally sealed for use in optical drop cable deployments
- Plug and play adapter ports ensure rapid cable installment in the outside plant access section of the network
- NOVUX™ HMT terminals are well suited for fiber-rich applications and available with 12 or 24 Fibers; no internal splitter option
- Available with flat dielectric up to 24 fiber or flat toneable/locatable up to 12 fiber. Terminals can be used as a distribution point within a network or as a final multifiber drop terminal where more than a single fiber is required to service an SFU or cellular tower
- NOVUX™ smaller terminal size for aesthetics and allowing installation in constrained spaces
- NOVUX™ terminals are available in Black (RAL# 9005) or Gray (RAL# 7035)
- CommScope Product ID plate with QR code link to product documents and C-Track

## Product Classification

<b>Regional Availability</b>	Asia   EMEA   Latin America   North America
<b>Product Type</b>	Access terminal, without splitter/tap
<b>Product Brand</b>	NOVUX™
<b>Product Series</b>	HMT
<b>Minimum Order Quantity</b>	1

## General Specifications

<b>Cable Type</b>	Dielectric - Flat - Loose Tube
<b>Cable, quantity</b>	1
<b>Distribution Type</b>	12 ports, 2 fibers per port
<b>Drop Port Type</b>	Hardened multi-fiber (HMFOC) jack, male/pinned
<b>Enclosure Color</b>	Black (RAL 9005)
<b>Multi-fiber Port Type</b>	Hardened multi-fiber (HMFOC) jack, male/pinned
<b>Multi-fiber Port, quantity</b>	12
<b>Mounting</b>	Handhole   Pedestal   Pole   Strand
<b>Port Type</b>	Hardened multi-fiber (HMFOC) jack, male/pinned
<b>Port, quantity</b>	12

# HMT-BCM2A0500NN000

## Stub Type

Stub tail

## Dimensions

### Height

80 mm | 3.15 in

### Width

128 mm | 5.039 in

### Length

207 mm | 8.15 in

### Cable Length, stub

500 ft (152 m)

## Dimension Drawing

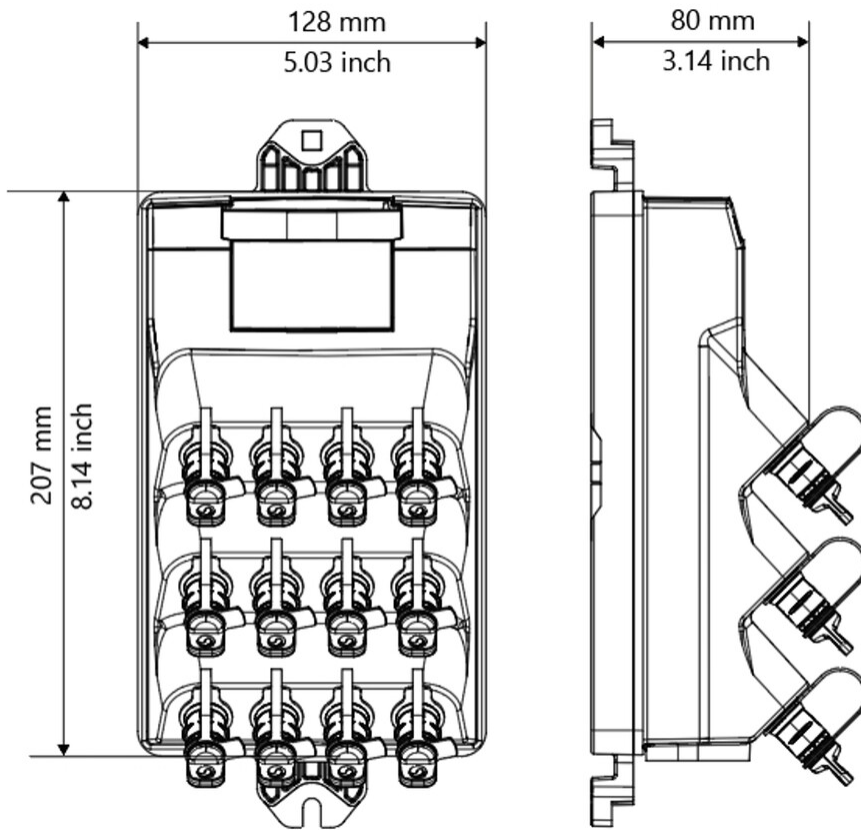

## Port Configuration

NOVUX HT	TECHNOLOGIES AVAILABLE	SMALL	MEDIUM	LARGE
HMT Series	Multi-fiber	Up to 24f	Up to 24f	Up to 24f
		2 ports, each 2, 4, 6, 8 or 12f	6 ports, each 2, 3 or 4f	12 ports, each 2f
		3 ports, each 2, 4, 6, or 8f	8 ports 2 or 3f	
		4 ports, each 2, 4, or 6f		

## Ordering Tree

# HMT-BCM2A0500NN000

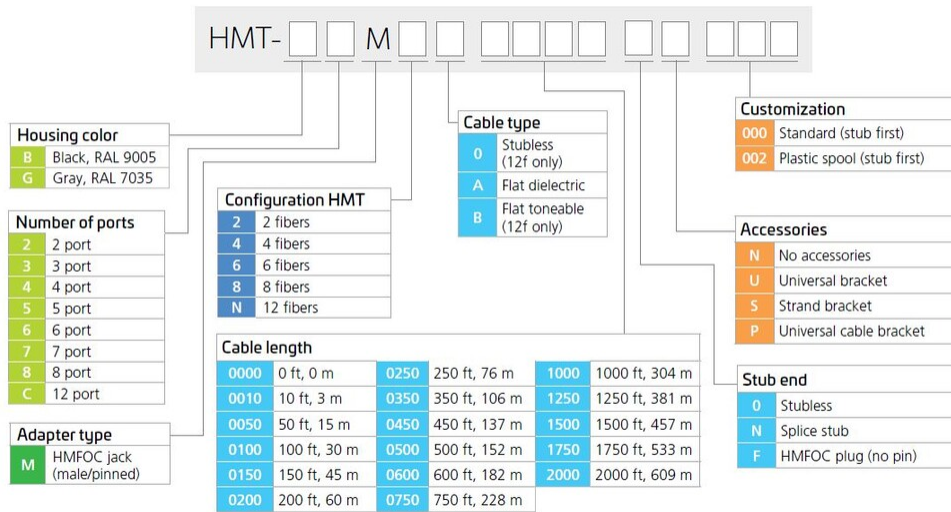

## Material Specifications

**Enclosure Material Type** Hardened plastic

## Optical Specifications

**Fiber Type** G.657.A1/A2

**Operating Wavelength Range** 1260 – 1635 nm

**Attenuation Single Ports, maximum** 0.65 dB

**Attenuation Cable Coefficient, maximum** 0.30 dB/km @ 1550 nm | 0.40 dB/km @ 1310 nm

**Return Loss, Connector, typical** 65 dB

## Environmental Specifications

**Operating Temperature** -40 °C to +65 °C (-40 °F to +149 °F)

**Relative Humidity** 5%–100%, condensing

**Environmental Space** Above ground | Below ground

**Qualification Standards** IEC 60529, IP68 + 2 m waterhead | IEC 61753-1, category G

**UV Resistance** UV stabilized

## Packaging and Weights

**Packaging quantity** 1

**Packaging Type** Box | Universal spool, wood: terminal is on the top of the spool, stub deploys first

# HMT-BCM2A0500NN000

---

## Regulatory Compliance/Certifications

<b>Agency</b>	<b>Classification</b>
CHINA-ROHS	Below maximum concentration value
ISO 9001:2015	Designed, manufactured and/or distributed under this quality management system
REACH-SVHC	Compliant as per SVHC revision on <a href="http://www.commscope.com/ProductCompliance">www.commscope.com/ProductCompliance</a>
ROHS	Compliant
UK-ROHS	Compliant

