

PM-SU4-B

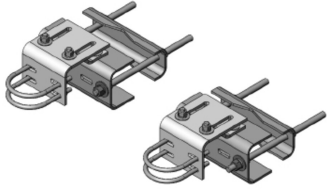

Universal Sliding Pipe Mount Base Kit for 4-1/2 in OD pipe

Product Classification

Product Type Pipe mount

General Specifications

Mounting Angle 60°, 203.2 mm (8 in) | Angle 90°, 152.4 mm (6 in) | Straight or tapered legs up to 203.2 mm (8 in) OD

Note One 96 in x 8 in panel antenna per sector

Pipe, quantity 0

Tower Taper Tapered

Dimensions

Height 127 mm | 5 in

Width 304.8 mm | 12 in

Length 304.8 mm | 12 in

Mounting Diameter, maximum 203.2 mm | 8 in

Mounting Diameter, minimum 0 mm | 0 in

Pipe Outer Diameter 114.3 mm | 4.5 in

PM-SU4-B

Outline Drawing

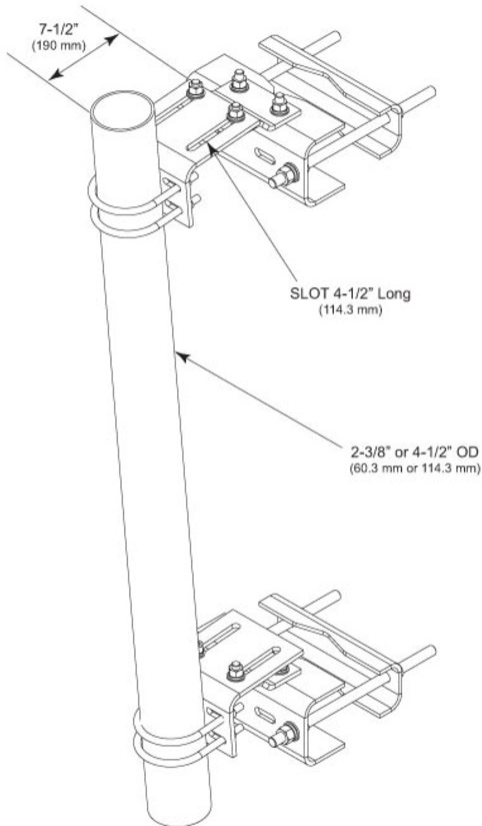

Material Specifications

Material Type Hot dip galvanized steel

Mechanical Specifications

Wind Rating 120 mph (BWS) at 150 ft AGL

Wind Rating Test Method TIA/EIA-222

Packaging and Weights

Included Sliding pipe mount brackets | Universal saddle mount

Packaging quantity 2

PM-SU4-B

Weight, net 36.8 kg | 81.13 lb

Regulatory Compliance/Certifications

Agency	Classification
ISO 9001:2015	Designed, manufactured and/or distributed under this quality management system

Included Products

PM-SL4	- Universal Taper Pipe Mount Slider Bracket for 4-1/2 in OD pipe
SM-U2080	- Universal Saddle Mount for straight or tapered legs up to 8 in OD, 8 in angle 60°, or 6 in angle 90° (Kit of 2)

* Footnotes

Wind Rating BWS—Base Wind Speed; FBC—Florida Building Code